

The JBL Intellivox Range

Beam Forming, Self Powered, Loudspeaker Arrays



PROFESSIONAL
by HARMAN



Beam Steering
and Beyond



Identifying the Problem

The Intellivox range is the perfect solution to one of the most difficult problems facing modern sound system designers - designing an intelligible sound reinforcement/public address system for a large reverberant space.

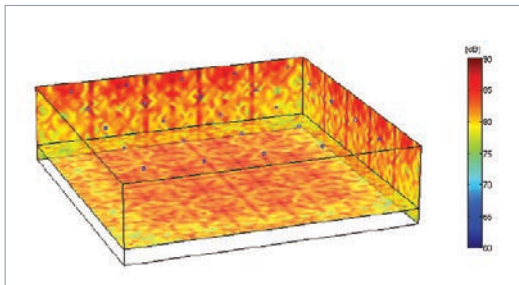

Direct SPL plot for traditional ceiling speakers

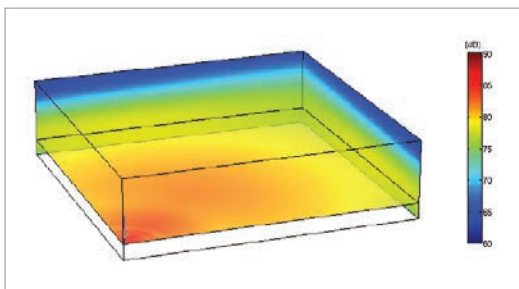

Direct SPL plot for single JBL Professional® Intellivox

The modern sound system designer has to choose products that will fit a large range of criteria.

The System Must:

- Sound Good
- Look Good
- Be Safe and Reliable
- Be Easy to Install and Maintain

All of these factors contribute to how the success of the installation will be judged.

So what happens when, as a designer, you're faced with a highly reverberant space?

The biggest challenge is designing a system which will have a high direct to reverberant sound ratio. In other words, we need to maximise the sound that arrives directly to the listener's ear, while at the same time reducing the sound energy that bounces off walls, ceilings and other acoustically reflective surfaces.

The solution seems simple. However, in practice it is difficult to achieve this with conventional loudspeakers.

This is why the Intellivox Range was developed.

Intellivox products use Duran Audio's highly advanced Digital Directivity Technologies - Digital Directivity Control (DDC) and Digital Directivity Synthesis (DDS), which allow you to control the vertical directivity pattern of Intellivox products and aim the sound where you want it - At the listener.

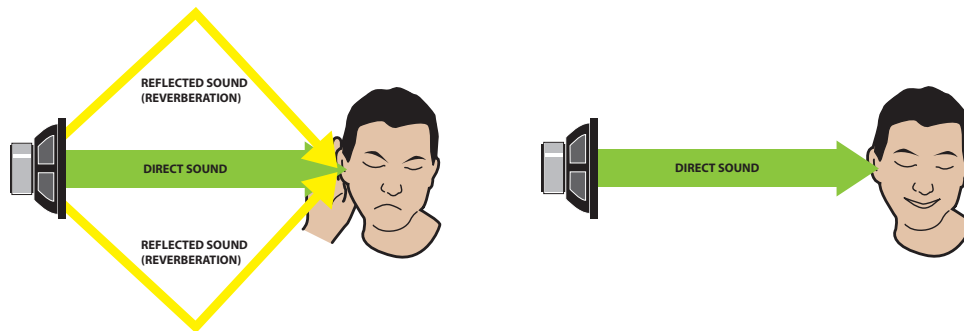

The problems associated with a highly reverberant space can be improved considerably, by aiming the sound at the listener and away from acoustically reflective surfaces.

To achieve such accurate directivity control from a loudspeaker array, the Intellivox has an integrated electronics module which combines powerful Digital Signal Processing with multi-channel class D amplifiers.

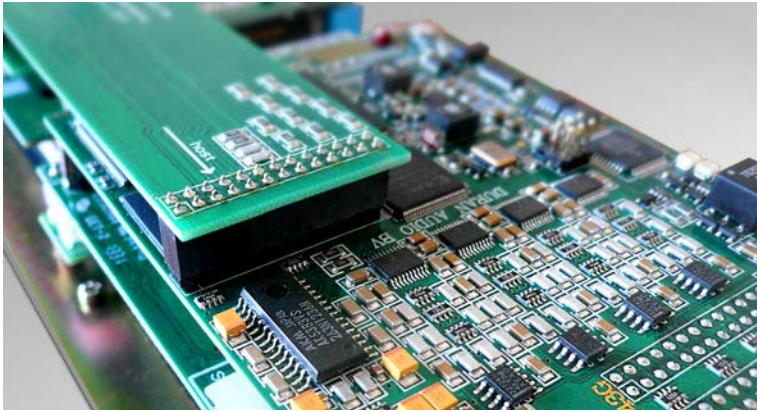

This electronics module comes network ready and can be controlled from the WinControl software, which is used to setup and monitor Intellivox installations.

Also available is DDA (Digital Directivity Analysis) which is a dedicated software tool that allows sound system designers to simulate and optimise the directional behaviour of the Intellivox products as well modeling the performance of other loudspeakers in the system.

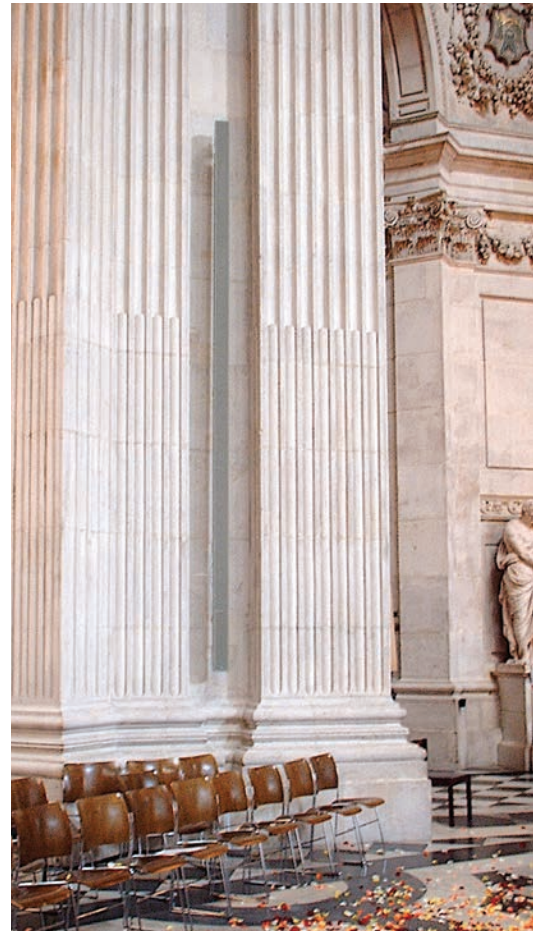

An Intellivox-DS500 installed at St Pauls Cathedral, London, UK

What is speech intelligibility and why is it important?

The purpose of an announcement through any public address system is to communicate a message. An email with half of the words missing would not be an acceptable form of communication, so why should you accept a similar effect from a poor public address system? You shouldn't. An unintelligible public address system is unsatisfactory!

If you can't understand it why not just turn the volume up?

Imagine if someone ran up to you in the street and shouted information to your face! Wouldn't it be more comfortable if that person approached you calmly and addressed you in a clear well spoken voice at a more moderate volume?

A loud public address system isn't necessarily an intelligible one. An intelligible system isn't necessarily a loud one.

With the arrival of digital audio we are all now used to high quality sound at home and on the move. This has set a new benchmark for quality. People now expect the same standard from a PA system without fully appreciating all the problems that exist in large spaces. The science of sound 'acoustics', is not a simple subject, the larger the room/space and the larger the system, the more difficult it becomes to maintain the quality.

Why Choose Intellivox?

A Great Sounding System

Quality Sound Reproduction –
Delivering the ultimate intelligibility

- Highly intelligible speech reinforcement
- Natural sound reproduction
- High direct-to-reverberant ratio
- Free from distortion
- Even SPL coverage (The sound level from a properly set up Intellivox unit will be the same, whether the listener is at a distance or close up)

(Digital directivity technologies ensure a high ratio of direct sound to reverberant sound which is critical to the intelligibility of any sound system)



Cologne Dome, Germany

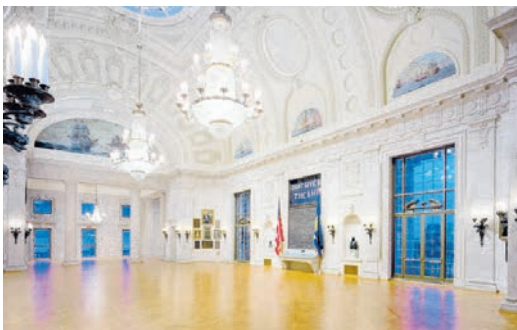

US Naval Academy, USA



A Great Looking System

Architectural Integration – For systems that look great and sound great

- No need for mechanical aiming
- Units can be mounted vertically
- Units can be recessed into surfaces
- Color matching service available
- Units have a slim and unobtrusive design
- Can be integrated into buildings of all ages and styles



Covington Cathedral, USA

A Safe and Reliable System

Emergency Sound Systems – Intellivox products are designed for use in emergency sound systems

- Designed to provide reliable operation
- In some cases, Intellivox products are the only way of achieving the required levels of speech intelligibility in a large reverberant space
- All elements of Intellivox products are constantly monitored by the on board RISC processor
- Faults can be reported via the built in failure relay or via the network
- WinControl servers can be supplied to provide fault logging and to interface to external controllers

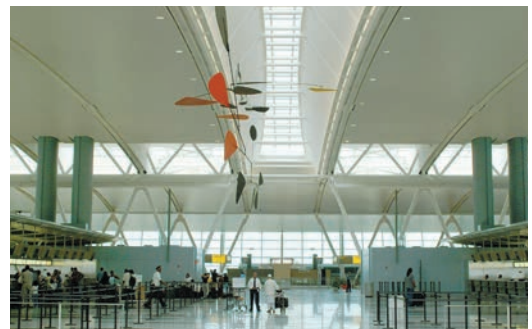

JFK Terminal 4, USA

An Easy To Install and Maintain System

Installation & Maintenance – Easy to install and maintain

- Fewer installation/maintenance points than conventional distributed systems
- Units can be configured from a single control point via an RS-485 network
- A wide range of mounting and cable entry options
- All parts & connections are accessible from the front as well as the rear of the unit making it possible to service the unit in situ
- Most units can be ordered with the electronics module at the top or bottom of the enclosure, allowing additional architectural flexibility



Kings Cross Station, UK

Intellivox DDC (Beam Steering)



DDC (Digital Directivity Control) is a multi-channel loudspeaker array technology where the single loudspeaker elements are positioned in space according to a patented algorithm.

Loudspeaker channels have their own dedicated audio path through the DSP and amplification which means that each loudspeaker, or group of loudspeakers, can have their own unique set of filters.

This technology enables users to electronically manipulate the vertical dispersion of an Intellivox array.

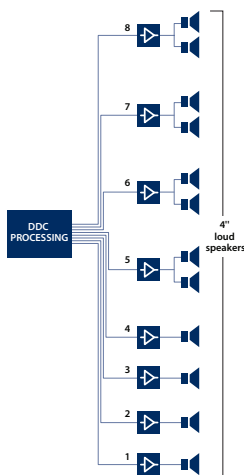

Block diagram showing DDC implementation for the JBL Professional® Intellivox-DC180

What does DDC have to offer?

The beam steering capability of the Intellivox means that you can maintain even coverage across the listening plane while steering the beam away from surfaces that may cause unwanted reflections.

This results in a very high direct to reverberant sound ratio which is essential for achieving acceptable levels of speech intelligibility within reverberant spaces. One way to visualise the dispersion is to imagine a pancake of sound coming from the array, by adjusting the elevation angle we can aim the pancake up or down from the acoustic centre. This technique also means that, unlike mechanically aimed passive arrays, the back radiated energy is also controlled. This control means that electronically aimed Intellivox arrays add far less energy to the reverberant field compared to conventional systems.

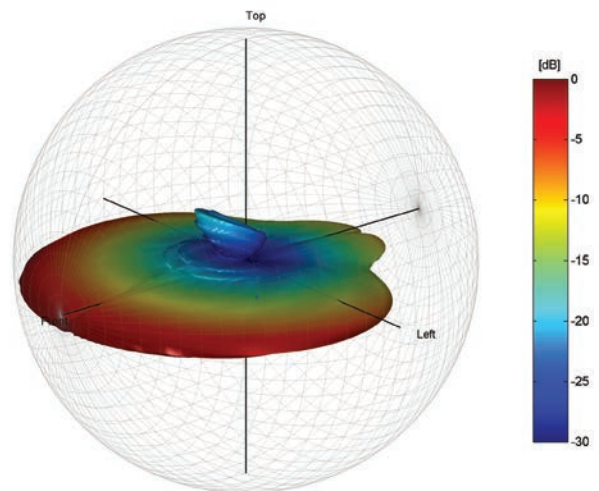

Intellivox DDC 3D directivity balloon

However, this is not the only benefit of the technology. DDC can also offer even SPL distribution over large distances. A well designed DDC installation can offer as little variation as 1 dB across the listening area. Taking an Intellivox-DC500 as an example one can measure the SPL at 5m and then measure again at 50m and see as little as 1 dB variation.

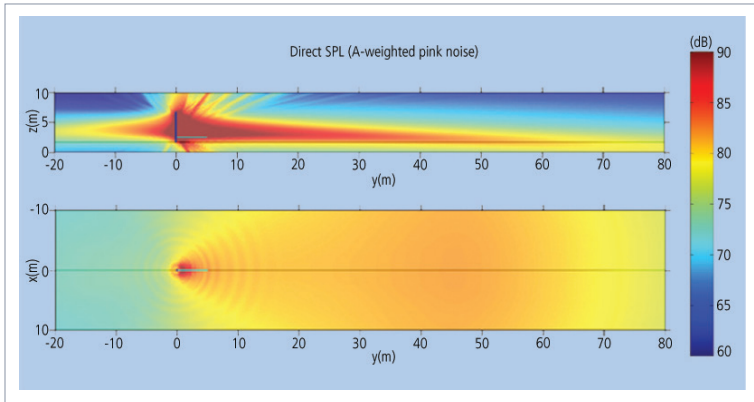

And for outdoor applications DDC technology can also offer solutions to problems associated with environmental noise pollution. DDC is simple and intuitive to setup using the DDC beam control parameters.

DDC Control Parameters:

- Opening Angle
- Aiming Angle
- Focus Distance

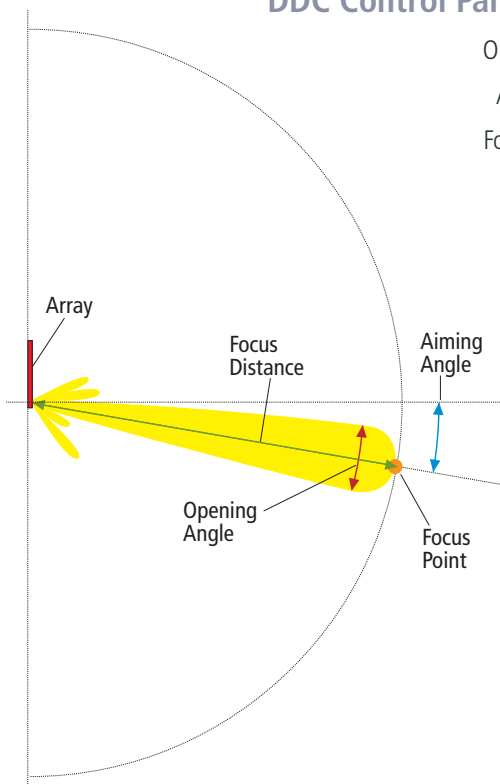

In addition to the main lobe, DDC also allows users to generate a second lobe from the array.

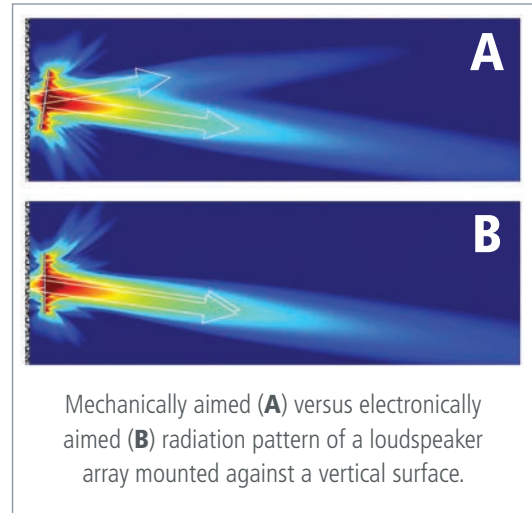

Mechanically aimed (A) versus electronically aimed (B) radiation pattern of a loudspeaker array mounted against a vertical surface.

The Intellivox is a digitally controlled loudspeaker which focuses the sound where you want it, at the listener.

In visual terms it can be thought as a spot light as opposed to a flood light. Intellivox loudspeakers have a very narrow vertical coverage angle and a very wide horizontal coverage angle. In large reverberant spaces this type of loudspeaker has many benefits:

- The sound is digitally aimed at the listener.
- There is less sound reflected from walls and ceilings therefore you hear less reflections
- It is highly efficient at distributing the available power from the loudspeaker
- The SPL of the loudspeaker is approximately the same if you are close or if you are 60 m away

The result is a very natural, clear and direct sound, which is essential for achieving the required levels of speech intelligibility and getting your announcement understood.

Intellivox DDS (Beam Shaping) - Beyond Beam Steering!

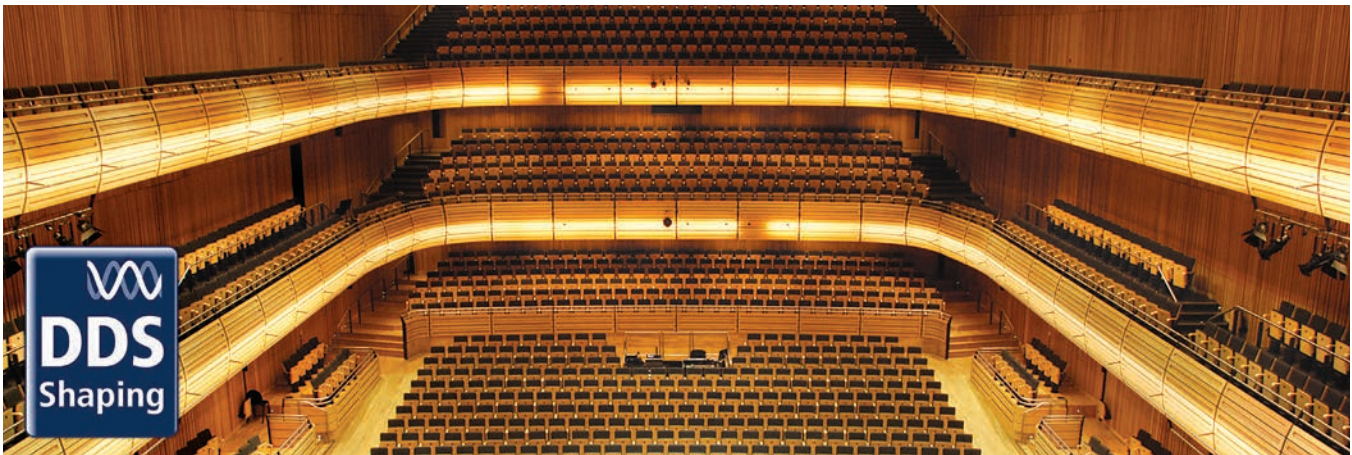

DDC (Beam Steering technology) is great for buildings which have flat audience plans. E.G. the nave of a cathedral, the platform of a train station or an airport concourse. But what happens when we have a more complex audience area like an auditorium?

That's when you need to go beyond Beam Steering and think about Beam SHAPING. After many years of experience with Beam Steering it became clear that there was another step required to gain the ultimate control over a loudspeaker array. For this reason Duran Audio developed DDS (Digital Directivity Synthesis) - Beam Shaping technology.

Beam Shaping technology allows users to control both the near and far field dispersion of any loudspeaker array; in this application it's applied to the vertical array of drivers in the Intellivox. While what happens within the DDS algorithm is very complex, we've packaged the technology in a way that's easy for users to apply. Leaving you to do your job and create a great sounding system.

Why is Beam shaping (DDS) better than other technologies that combine multiple beams?

Multiple beams overlap and you then have areas where you have destructive interaction between the beams. Beam shaping is a far superior, elegant and accurate way of achieving the desired coverage.

DDS Workflow

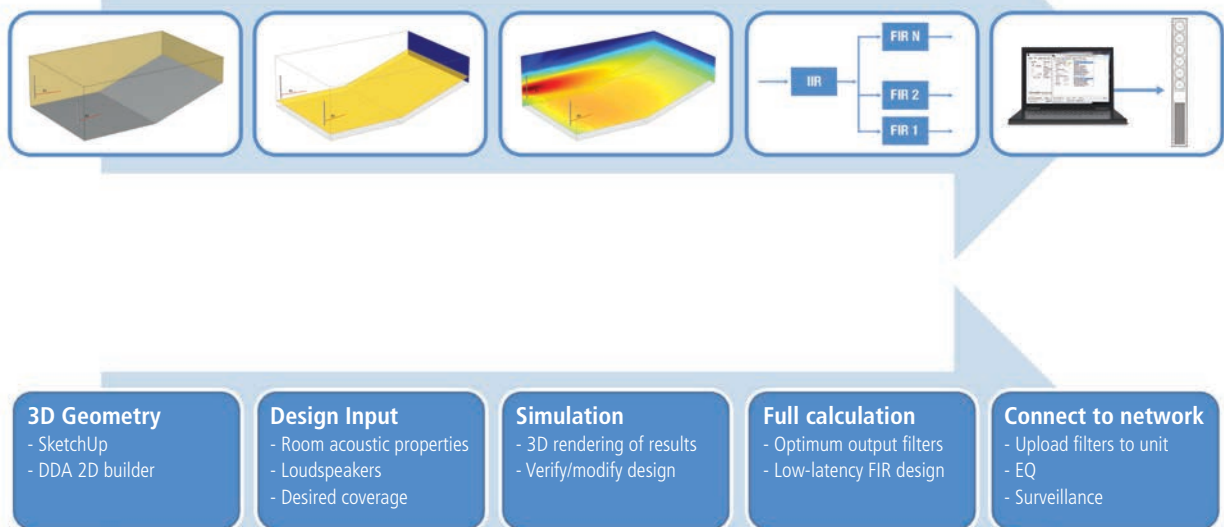

What if you could stand in a room, imagine your desired system performance and make it possible at the touch of a button...

Digital Directivity Synthesis (DDS) offers the solution!

DDS allows users to create the best possible coverage with the maximum direct to reverberant ratio for any given situation. DDS users can not only define what areas are to be covered by an Intellivox but also define areas that should be avoided, resulting in the best possible suppression of unwanted reflections. This is invaluable in controlling attributes such as stage-feedback or suppressing rear wall reflections. The powerful DDS technology provides the user unrestricted electro-acoustical system control.

How do you do it?

Using Duran Audio's DDA (Digital Directivity Analysis) software the user can define the array position and the audience area and allow the DDS algorithm to produce the best possible fit. The result is a complex dispersion pattern that "fits" the audience area. Allowing designers to excite the audience and not the room.

When would I use DDS instead of DDC technology?

DDC Technology makes it possible to achieve even SPL coverage and high direct to reverberant ratio in an environment where you have a flat audience area.

DDS Technology makes it possible to produce the same outstanding results in the most complex of spaces.

With DDS technology it is possible to optimize arrays with different transducer types such as the DSX range of products.

Benefits of the DDS concept include:

- Flexible array set-up
- Pre-defined direct SPL distribution over (complex-shaped) audience planes while minimum energy projection at hall boundaries
- Constant spectral balance for all listening positions
- Optimum direct-to-reverberant energy ratio
- Both far field and near field control

The JBL® Intellivox DSX Range

Boasting the addition of 1" horn loaded dome tweeters and an extended frequency range of 130 - 18 kHz, The JBL Intellivox DSX range has been introduced for applications that require improved music clarity as well as speech intelligibility.

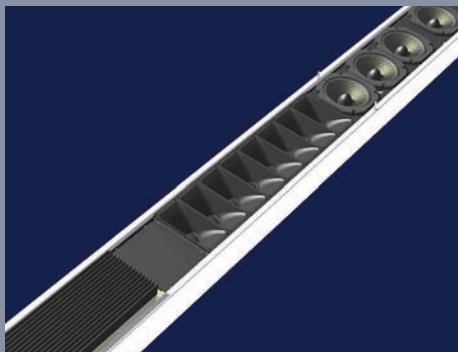

Intellivox DDS examples

Data Entered into DDA

Results from DDA

Floor Only - DDS settings

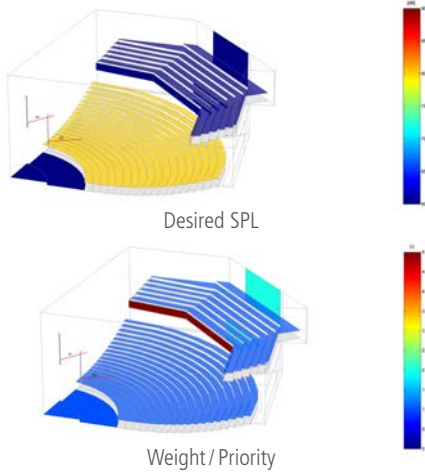

Floor Only - DDS optimisation results

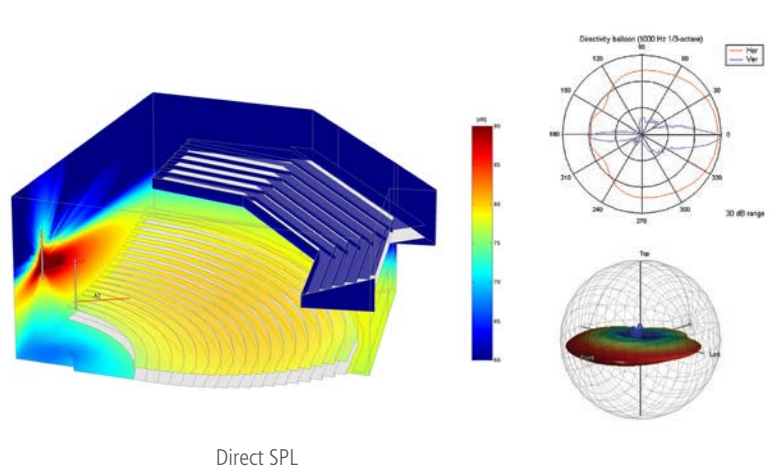

Balcony Only - DDS settings

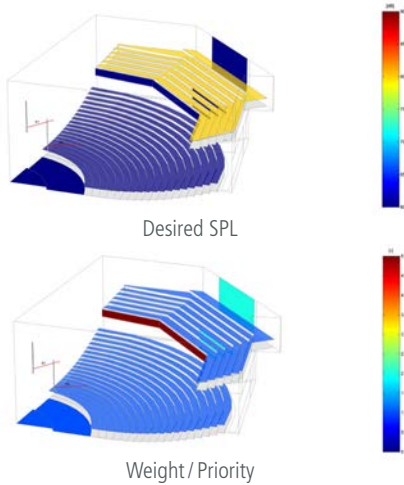

Balcony Only - DDS optimisation results

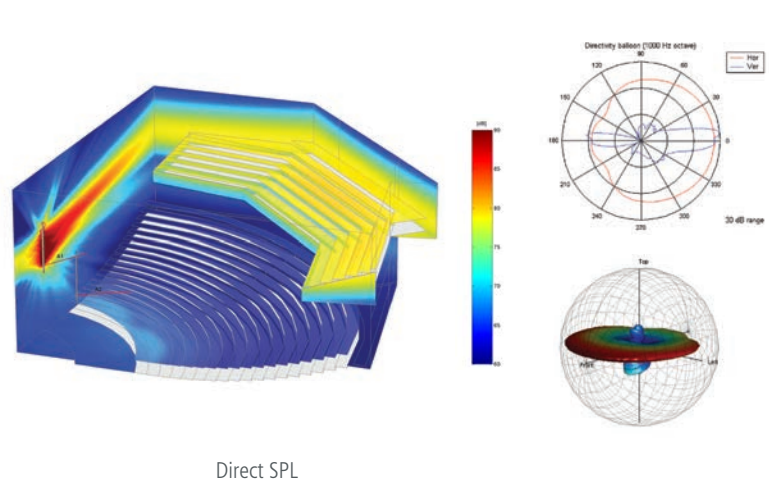

Floor & Balcony - DDS settings

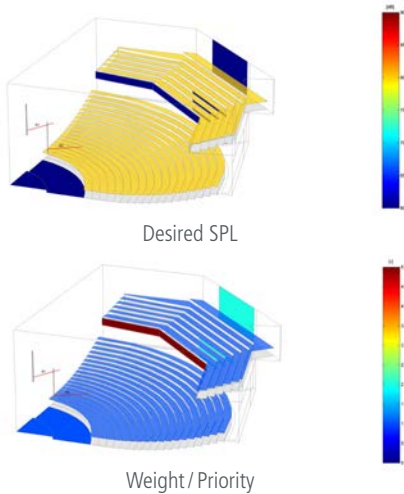

Floor & Balcony - DDS optimisation results

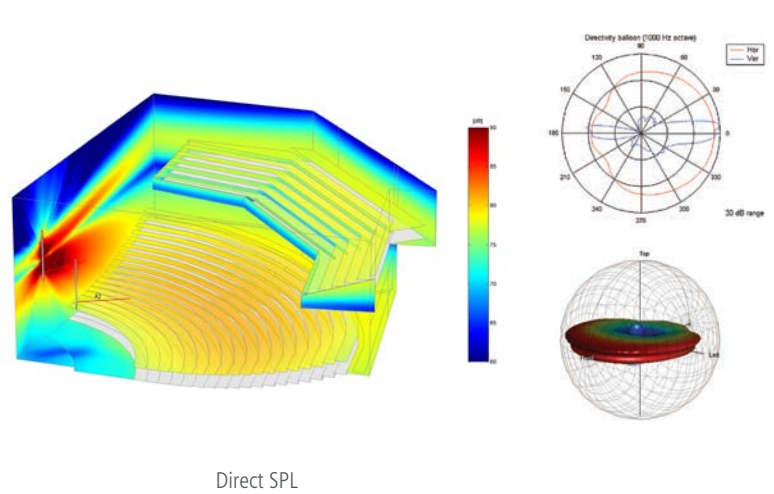

Examples showing how the same physical array configuration can be adapted to different situations using DDS.

DDA Electro-Acoustic Software

DDA (Digital Directivity Analysis) is a dedicated electro-acoustic tool that allows sound system designers to design, simulate, visualise and optimise the directional behaviour of JBL Intellivox, JBL AXYS® products and JBL point source loudspeakers (CLF data required).

DDA is a 3D fast modelling environment designed to run on Windows. Models can be imported into DDA from CATT Acoustic®, EASE® or ODEON® acoustic modelling software packages or built in DDA using the 2D geometry builder. Third party plug-ins are also available to import 3D SketchUp® models into DDA.

As well as providing the tools for users to define the dispersion of DDS driven arrays DDA also allows you to predict and visualise:

- Direct SPL
- Polar responses
- Direct to reverberant ratio*
- Speech intelligibility index*
- System headroom
- Direct sound frequency response

* Calculated statistically

Other Features Include:

- Delay Optimisation
- Directivity Data Export to CATT Acoustic or ODEON

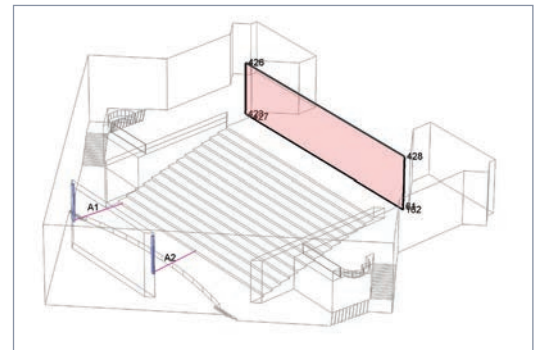

Plane Properties

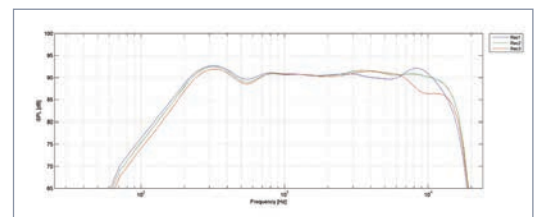

Direct Sound Frequency Response

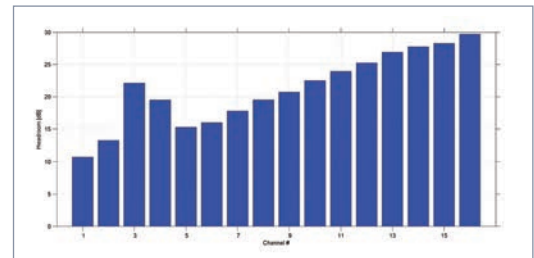

System Headroom

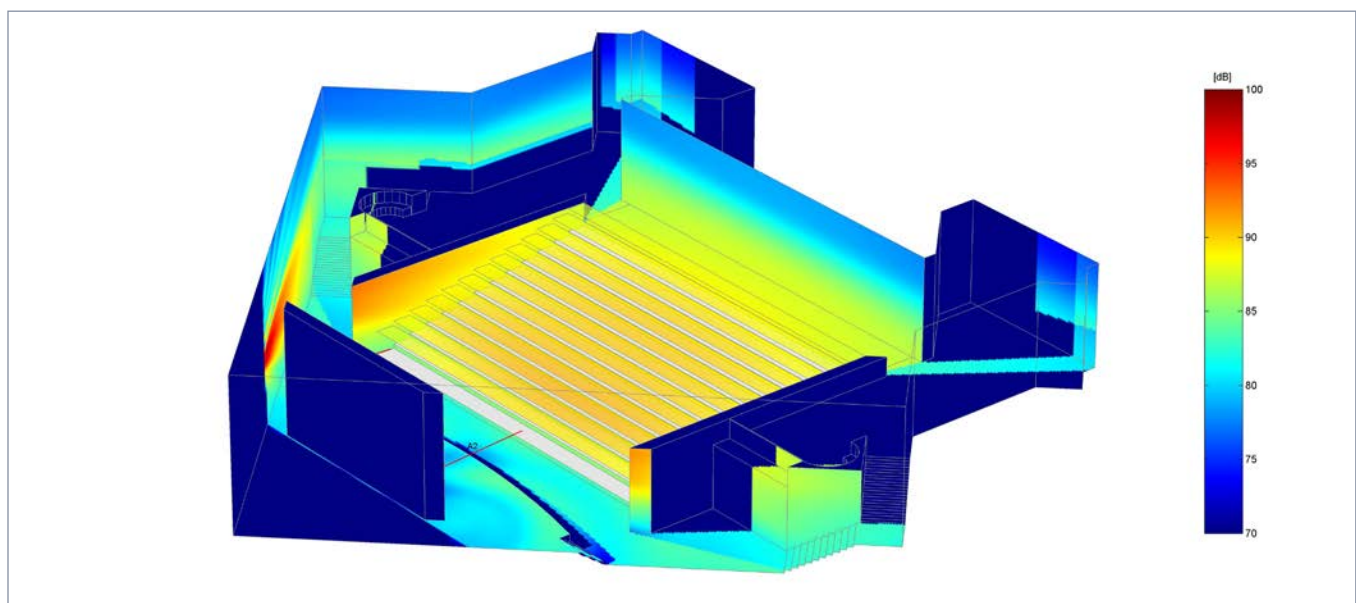

Direct SPL

WinControl Software

Intellivox products are configured using our proprietary WinControl software, communication between the PC running WinControl and the Intellivox is via a RS-485 network. WinControl allows users to manipulate the critical digital directivity parameters that define the vertical dispersion of the array.

Further control is offered to the user, through functions which include:

- Volume control
- Eight band parametric EQ
- Delay, up to 20 seconds
- AVC functions
- Surveillance related parameters

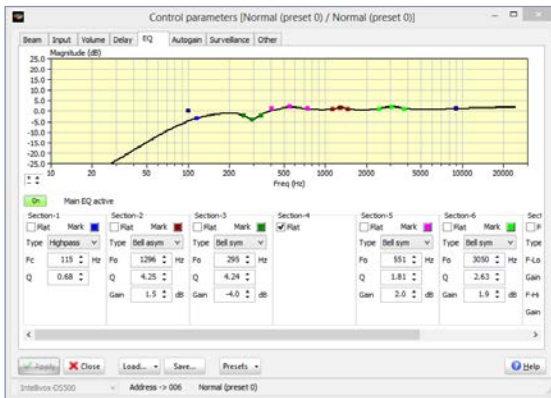

In addition to this the Intellivox DDC and DDS products are fitted with dual line level inputs; each input has independent:

- Level control
- Delay, up to 10 seconds
- Four band parametric EQ
- Pilot tone detection

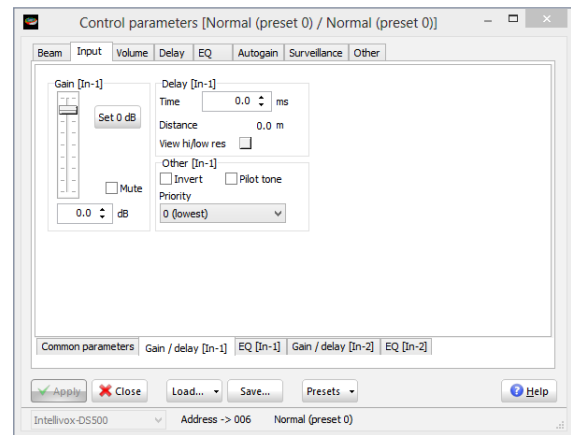

The inputs can be configured to work in one of three ways:

- Inputs can be summed
- Level controlled priority switching
- Pilot tone controlled priority switching

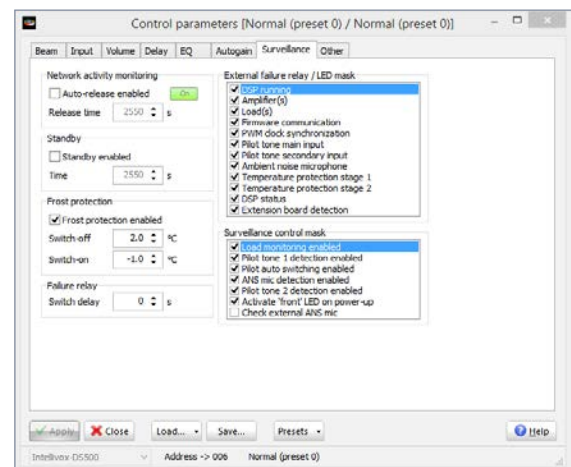

Intelligibility and the Law

Public address installations are quite often used as voice alarm systems, which form part of a buildings fire alarm/ life safety setup. In these circumstances they are subject to regulations and minimum standards which not only dictate how they are installed and monitored but also set minimum standards for intelligibility. For this type of safety critical system the most important factor is the Intelligibility. The quicker people understand the instructions being given to them then the quicker they can act upon them!

The safest system is a system where the announcement is understood the first time it is made.

Once the units have been configured, the PC can be removed from the network as the settings are stored in non-volatile memory. Note that if network cabling is installed, the Intellivox must be either connected to a PC running WinControl or the cables should be terminated.

Safety Features



Apart from the DSP, Intellivox products are equipped with a RISC processor that takes care of all the surveillance routines, which are performed every 1/20 second. In addition to this the RISC is monitored by a watchdog, which in the event of a failure will reset the RISC.

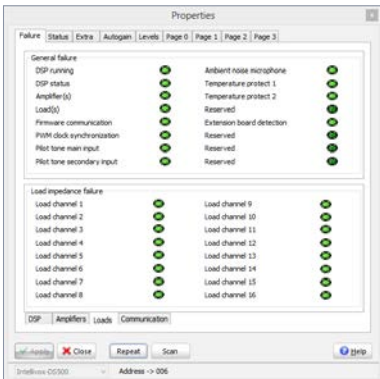

Surveillance functions include, but are not limited to:

- Pilot tone detection
- Amplifier load surveillance
- Ambient microphone surveillance
- Amplifier surveillance
- Temperature surveillance
- DSP functionality

All relevant status parameters and temperatures can be monitored via the RS-485 network. Failures can be reported by the on board failure relay or via one of the many features offered by WinControl.

WinControl Server

WinControl server is an industrial-standard PC running the Service version of WinControl software. This combination allows monitoring of the entire audio system from a central point, plus full control and configuration of Intellivox or JBL AXYS components. As well as visual indication of system status, it also provides fault logging and fault reporting via email. A programmable failure relay can be wired to an external alarm or BMS to give an overall system fault warning. A message store is incorporated allowing emergency or advisory announcements to be triggered or played automatically.

A multi-function external control port allows WinControl server to be interfaced to external SCADA, BMS or other control systems. This can be used to trigger messages, request status reports from other system components, mute/unmute selected amplifiers and/or loudspeakers, load specific configuration presets into amplifiers or loudspeakers, etc.

WinControl server communicates with other JBL Intellivox or JBL AXYS products via either RS-485 or CobraNet. In the event of an application or OS crash, an onboard watchdog reboots the PC, with no impact on audio transmission through the other system components. The software has multiple, password-protected access levels.

For fully redundant operation, two WinControl Servers may be installed in a "hot-hot" configuration, with autonomous control of master/slave status being applied via the external control port.

- Dedicated industrial-quality server computer
- Runs Service (enhanced) version of WinControl software
- Provides control/monitoring of an entire distributed audio system
- Full fault logging with alerts
- Incorporates message store for announcements
- Interface with system components via RS-485, CobraNet® and external control port
- Automatic reboot on crash

Choosing your Intellivox Product

Which technology is best for your installation?

Well there are some simple rules of thumb:

DDC Technology - Intellivox DC products are best suited to flat audience planes where the acoustic centre of the array can be located between 0.5m and 0.75m above the audience plane.
 DDS Technology - Intellivox DS and DSX products are best suited to complex audience planes (theatres, concert halls, stadia, lecture theatres) or to applications where the Intellivox is forced to be mounted with the acoustic centre located more than 0.75m above the audience place.

Which array length is best for your installation?

As a rule of thumb the following table can be used.

Intellivox Type	Length*	Typical throw
DC/DS 115	1.15 m / 3.7 ft	10 - 20 m / 33 - 66 ft
DC/DS/DSX 180	1.80 m / 5.9 ft	15 - 25 m / 49 - 82 ft
DC/DS/DSX 280	2.80 m / 9.2 ft	20 - 35 m / 66 - 115 ft
DC/DS/DSX 380	3.80 m / 12.5 ft	30 - 45 m / 98 - 148 ft
DC/DS/DSX 430	4.30 m / 14.1 ft	40 - 55 m / 131 - 181 ft
DC/DS/DSX 500	5.00 m / 16.4 ft	50 - 70 m / 164 - 230 ft

* Lengths are approximate

For applications where high SPL levels are required or full range sound reinforcement then the Intellivox HP (High Power) series can be used.

Intellivox Type	Length*	Typical throw
HP-DS 170	1.7 m / 5.6 ft	10 - 25 m / 33 - 82 ft
HP-DS 370	3.7 m / 12.1 ft	25 - 50 m / 82 - 164 ft

* Lengths are approximate

Size is important!

The directivity control at the lower frequencies is dependent upon the array length (you need a long array to control the long wavelengths) so in spaces where the reverberation times are very high it may be desirable to use a DS500, for example, to cover a 50 m area as it would allow you to achieve a higher ratio of direct sound to reverberant sound and therefore a higher level of speech intelligibility.

The 3D directivity balloons shown below show the difference in directivity between an Intellivox-DS280 and DS500 at 100 Hz.

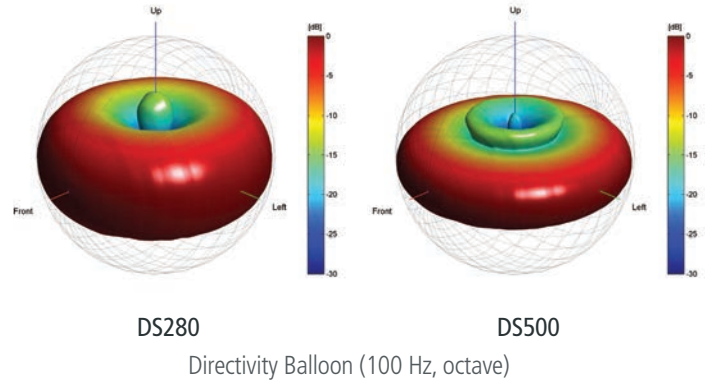

Verify your design

While the rules of thumb are a good starting point for any design you should always verify your design using the DDA software. Our application support team are also available to assist you.

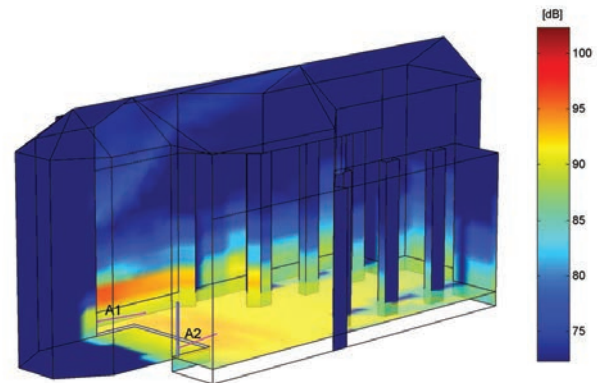

Example DDC application

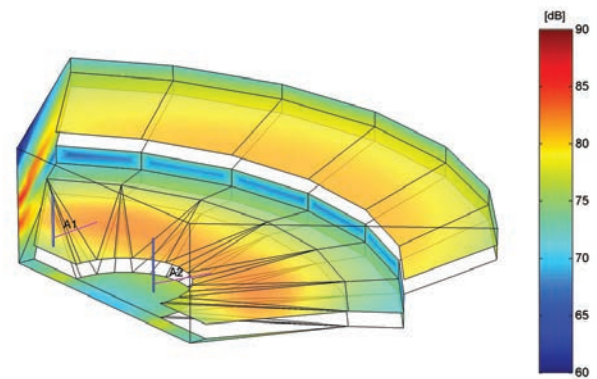

Example DDS application

The JBL Professional® Intellivox family

1. DC / DS / DSX500
2. DC / DS / DSX430
3. DC / DS / DSX380
4. HP-DS 370
5. DC / DS / DSX280
6. DC / DS / DSX180
7. HP-DS 170
8. DC / DS115

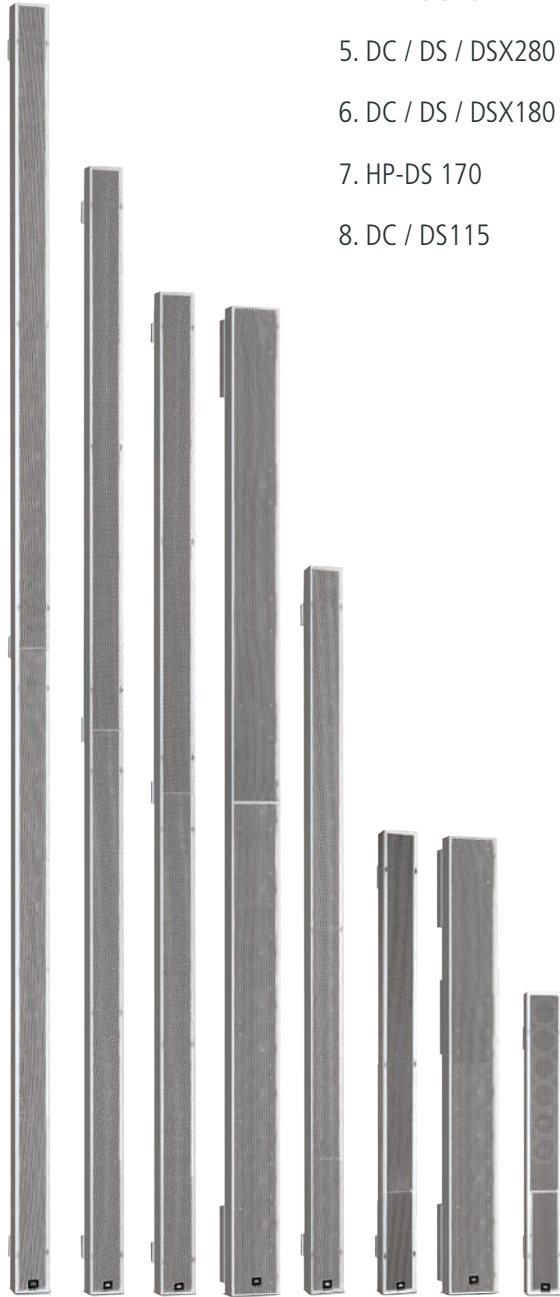

1 2 3 4 5 6 7 8

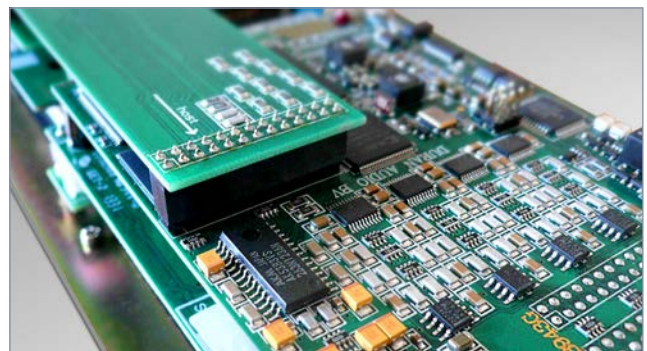

Intellivox family (DDS technology – Beam Shaping)



Standard SPL - Speech and Background Music

Extended HF

	Ivx-DS115	Ivx-DSX180	Ivx-DSX280 HD	Ivx-DSX380 HD	Ivx-DSX430	Ivx-DSX500
Frequency Range (+/-3 dB)	130 - 20k Hz	130 - 18k Hz	130 - 18k Hz	130 - 18k Hz	130 - 18k Hz	130 - 18k Hz
Max SPL (A-weighted at 30 m)						
- Continuous	85 B SPL	89 dB SPL	90 dB SPL	91 dB SPL	91 dB SPL	96 dB SPL
- Peak	88 dB SPL	92 dB SPL	93 dB SPL	94 dB SPL	94 dB SPL	99 dB SPL
Coverage						
- Horizontal (Fixed)	130°	130°	130°	130°	130°	130°
- Vertical (Adjustable)	Defined by DDS Algorithm	Defined by DDS Algorithm	Defined by DDS Algorithm	Defined by DDS Algorithm	Defined by DDS Algorithm	Defined by DDS Algorithm
- Typical maximum throw	10-20 m / 33-66 ft	15-25 m / 49-82 ft	20-35 m / 66-115 ft	30-45 m / 98-148 ft	40-55 m / 131-181 ft	50-70 m / 164-230 ft
Dynamic Range	>100 dB	>100 dB	>100 dB	>100 dB	>100 dB	>100 dB
Audio Inputs						
- Nominal level	0 dBV (line)	0 dBV (line)	0 dBV (line)	0 dBV (line)	0 dBV (line)	0 dBV (line)
- Type (Balanced)	transformer	transformer	transformer	transformer	transformer	transformer
- Impedance (Balanced)	6k8 Ω	6k8 Ω	6k8 Ω	6k8 Ω	6k8 Ω	6k8 Ω
Power Amps						
- Type	PWM (class D)	PWM (class D)	PWM (class D)	PWM (class D)	PWM (class D)	PWM (class D)
- Power (4 Ω)	8 x 40Wrms	8 x 40Wrms	16 x 40Wrms	16 x 40Wrms	16 x 40Wrms	16 x 40Wrms
Mains Voltage	230 or 115 V	230 or 115 V	230 or 115 V	230 or 115 V	230 or 115 V	230 or 115 V
Power Consumption						
- Idle	58 VA	58 VA	84 VA	84 VA	84 VA	84 VA
- Full load	325 VA	408 VA	650 VA	800 VA	750 VA	920 VA
Temperature Range (Ambient)	0 to 40° C	0 to 40° C	0 to 40° C	0 to 40° C	0 to 40° C	0 to 40° C
Transducers	60 x 4" 2 x tweeter	10 x 4" 4 x tweeter	12 x 4" 4 x tweeter	16 x 4" 4 x tweeter	13 x 4" 8 x tweeter	28 x 4" 8 x tweeter
Dimensions						
- Height	1149 mm	1780 mm	2800 mm	3750 mm	4350 mm	4930 mm
- Width	134 mm	134 mm	134 mm	134 mm	134 mm	134 mm
- Depth	92 mm	92 mm	92 mm	92 mm	92 mm	92 mm
Default Color	RAL 9010	RAL 9010	RAL 9010	RAL 9010	RAL 9010	RAL 9010
Weight	13 kg / 28.6 lb	19 kg / 41.8 lb	25 kg / 55.1 lb	35 kg / 77 lb	37 kg / 81.5 lb	44 kg / 97 lb

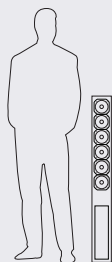

Ivx-DS115

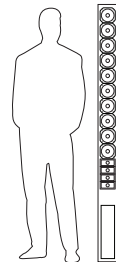

Ivx-DSX180

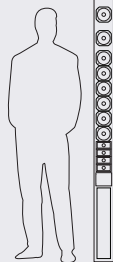

Ivx-DSX280 HD

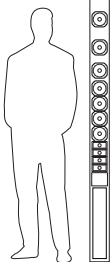

Ivx-DSX380 HD

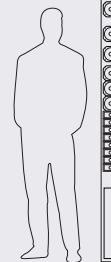

Ivx-DSX430

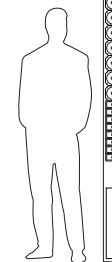

Ivx-DSX500



High Power
Extended HF

	Ivx-HP-DS170	Ivx-HP-DS370
Frequency Range (+/-3 dB)	140 - 18k Hz	140 - 18k Hz
Max SPL (A-weighted at 30 m)		
- Continuous	97 dB SPL	97 dB SPL
- Peak	105 dB SPL	105 dB SPL
Coverage		
- Horizontal (Fixed)	100°	100°
- Vertical (Adjustable)	Defined by DDS Algorithm	Defined by DDS Algorithm
- Typical maximum throw	10-25 m / 33-82 ft	25-50 m / 82-164 ft
Dynamic Range	>98 dB	>98 dB
Audio Inputs		
- Nominal level	0 dBV (line)	0 dBV (line)
- Type (Balanced)	transformer	transformer
- Impedance (Balanced)	6k8 Ω	6k8 Ω
Power Amps		
- Type	PWM (class D)	PWM (class D)
- Power (4 Ω)	12 x 100 Wrms	16 x 100 Wrms
Mains Voltage	100 or 240 V	100 or 240 V
Power Consumption		
- Idle	35W/0.29A @ 230V	40W/0.3A @ 230V
- Full load	860W/3.8A @ 230V	860W/3.8A @ 230V
Temperature Range (Ambient)	0 to 50° C	0 to 50° C
Transducers	10 x 6.5" 2 x Compression Drivers (1")	14 x 6.5" 2 x Compression Drivers (1")
Dimensions		
- Height	1698 mm	3738 mm
- Width	198 mm	198 mm
- Depth	189 mm	189 mm
Default Color	RAL 9010	RAL 9010
Weight	56 kg / 123 lb	82 kg / 181 lb
IP Rating	IP55	IP55

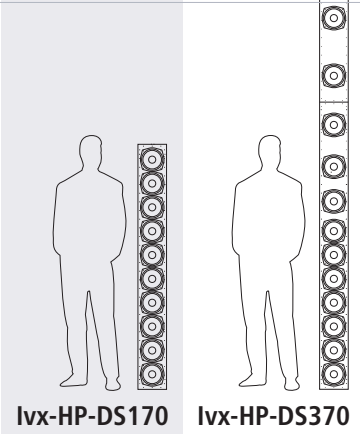

For music applications we recommend the addition of a subwoofer to extend the low frequency response of Intellivox systems. The JBL AXYS UB-25 makes use of Beam Shaping (DDS) technology and can be combined in the software to perform as a single array with an Intellivox, the software then optimizes the cross-over points and time alignment of the system as well as the directivity control. For another option consider the JBL PRX715XLF.



UB-25



PRX715XLF

Intellivox Special Order - DC family (DDC technology – Beam Steering)



Standard SPL - Speech and Background Music

Extended HF

	Ivx-DC115	Ivx-DC180	Ivx-DC280	Ivx-DC380	Ivx-DC430	Ivx-DC500
Frequency Range (+/-3 dB)	130 - 20k Hz	130 - 10k Hz	130 - 10k Hz	130 - 10k Hz	130 - 10k Hz	130 - 10k Hz
Max SPL (A-weighted at 30 m)						
- Continuous	85 dB SPL	90 dB SPL	92 dB SPL	92 dB SPL	92 dB SPL	97 dB SPL
- Peak	88 dB SPL	93 dB SPL	95 dB SPL	95 dB SPL	95 dB SPL	100 dB SPL
Coverage						
- Horizontal (Fixed)	130°	130°	130°	130°	130°	130°
- Vertical (Adjustable)						
- Opening angle	15° to 40°	8° to 20°	6° to 14°	6° to 14°	6° to 14°	4° to 10°
- Aiming angle	-16° to 16°	-16° to 16°	-16° to 16°	-16° to 16°	-16° to 16°	-16° to 16°
- Focus distance	2 m to 40 m	5 m to 100 m	5 m to 100 m	5 m to 100 m	5 m to 100 m	5 m to 100 m
- Typical maximum throw	10-20 m / 33-66 ft	15-25 m / 49-82 ft	20-35 m / 66-115 ft	30-45 m / 98-148 ft	40-55 m / 131-181 ft	50-70 m / 164-230 ft
Dynamic Range	>100 dB	>100 dB	>100 dB	>100 dB	>100 dB	>100 dB
Audio Inputs						
- Nominal level	0 dBV (line)	0 dBV (line)	0 dBV (line)	0 dBV (line)	0 dBV (line)	0 dBV (line)
- Type (Balanced)	transformer	transformer	transformer	transformer	transformer	transformer
- Impedance (Balanced)	6k8 Ω	6k8 Ω	6k8 Ω	6k8 Ω	6k8 Ω	6k8 Ω
Power Amps						
- Type	PWM (class D)	PWM (class D)	PWM (class D)	PWM (class D)	PWM (class D)	PWM (class D)
- Power (4 Ω)	8 x 40 Wrms	8 x 40 Wrms	8 x 40 Wrms	16 x 40 Wrms	16 x 40 Wrms	16 x 40 Wrms
Mains Voltage	230 or 115 V	230 or 115 V	230 or 115 V	230 or 115 V	230 or 115 V	230 or 115 V
Power Consumption						
- Idle	58 VA	58 VA	58 VA	84 VA	84 VA	84 VA
- Full load	325 VA	408 VA	450 VA	800 VA	750 VA	920 VA
Temperature Range (Ambient)	0 to 40° C	0 to 40° C	0 to 40° C	0 to 40° C	0 to 40° C	0 to 40° C
Transducers	6 x 4" 2 x tweeter	12 x 4" -	16 x 4" -	20 x 4" -	17 x 4" -	32 x 4" -
Dimensions						
- Height	1149 mm	1780 mm	2800 mm	3750 mm	4350 mm	4930 mm
- Width	134 mm	134 mm	134 mm	134 mm	134 mm	134 mm
- Depth	92 mm	92 mm	92 mm	92 mm	92 mm	92 mm
Default Color	RAL 9010	RAL 9010	RAL 9010	RAL 9010	RAL 9010	RAL 9010
Weight	13 kg / 28.6 lb	19 kg / 41.8 lb	25 kg / 55.1 lb	35 kg / 77 lb	37 kg / 81.5 lb	44 kg / 97 lb
	Ivx-DC115	Ivx-DC180	Ivx-DC280	Ivx-DC380	Ivx-DC430	Ivx-DC500

Intellivox Special Order - DS family (DDS technology – Beam Shaping)



Standard SPL - Speech and Background Music

	Ivx-DS180	Ivx-DS280	Ivx-DS380	Ivx-DS430	Ivx-DS500
Frequency Range (+/-3 dB)	130 - 10k Hz	130 - 10k Hz	130 - 10k Hz	130 - 10k Hz	130 - 10k Hz
Max SPL (A-weighted at 30 m)					
- Continuous	90 dB SPL	92 dB SPL	92 dB SPL	92 dB SPL	97 dB SPL
- Peak	93 dB SPL	95 dB SPL	95 dB SPL	95 dB SPL	100 dB SPL
Coverage					
- Horizontal (Fixed)	130°	130°	130°	130°	130°
- Vertical (Adjustable)	Defined by DDS Algorithm	Defined by DDS Algorithm	Defined by DDS Algorithm	Defined by DDS Algorithm	Defined by DDS Algorithm
- Typical maximum throw	15-25 m / 49-82 ft	20-35 m / 66-115 ft	30-45 m / 98-148 ft	40-55 m / 131-181 ft	50-70 m / 164-230 ft
Dynamic Range	>100 dB	>100 dB	>100 dB	>100 dB	>100 dB
Audio Inputs					
- Nominal level	0 dBV (line)	0 dBV (line)	0 dBV (line)	0 dBV (line)	0 dBV (line)
- Type (Balanced)	transformer	transformer	transformer	transformer	transformer
- Impedance (Balanced)	6k8 Ω	6k8 Ω	6k8 Ω	6k8 Ω	6k8 Ω
Power Amps					
- Type	PWM (class D)	PWM (class D)	PWM (class D)	PWM (class D)	PWM (class D)
- Power (4 Ω)	8 x 40 Wrms	8 x 40 Wrms	16 x 40 Wrms	16 x 40 Wrms	16 x 40 Wrms
Mains Voltage	230 or 115 V	230 or 115 V	230 or 115 V	230 or 115 V	230 or 115 V
Power Consumption					
- Idle	58 VA	58 VA	84 VA	84 VA	84 VA
- Full load	408 VA	450 VA	800 VA	750 VA	920 VA
Temperature Range (Ambient)	0 to 40° C	0 to 40° C	0 to 40° C	0 to 40° C	0 to 40° C
Transducers	12 x 4"	16 x 4"	20 x 4"	17 x 4"	32 x 4"
-	-	-	-	-	-
Dimensions					
- Height	1780 mm	2800 mm	3750 mm	4350 mm	4930 mm
- Width	134 mm	134 mm	134 mm	134 mm	134 mm
- Depth	92 mm	92 mm	92 mm	92 mm	92 mm
Default Color	RAL 9010	RAL 9010	RAL 9010	RAL 9010	RAL 9010
Weight	19 kg / 41.8 lb	25 kg / 55.1 lb	35 kg / 77 lb	37 kg / 81.5 lb	44 kg / 97 lb
IP Rating	-	-	-	-	-
	Ivx-DS180	Ivx-DS280	Ivx-DS380	Ivx-DS430	Ivx-DS500

Other Intellivox Products

Intellivox ADC (Beam Steered - Fixed Beam)

All the benefits of Intellivox technology in a 70V/100V column Analogue Directivity Control



EN54-24 Certified for Voice Alarm -
Emergency Sound Systems

(Suitable for outdoor use)

The Intellivox ADC range, which makes use of Intellivox technology, is intended for use in 70V/100V Public Address and Voice Alarm (PA/VA) systems. Each array consists of 6 carefully aligned 4" full range loudspeakers housed inside a tough steel enclosure. The specially aligned drivers are highly efficient and have an extended flat frequency response, providing natural and uncoloured reproduction of both spoken word and background music. Units can be ordered in EN54:24 compliant versions and these units are classified as Type B; suitable for outdoor use.



Intellivox-V90 MKII

Intellivox-V90 MKII is designed for PA/VA use in reverberant environments and can accurately cover a listening plane of 10-15 metres from the array. This is possible thanks to the fixed 30 degree vertical opening angle and a -4° downward steering angle which is implemented inside the unit. This not only offers class leading directivity control but also looks great as it allows the unit to be mounted flat onto a vertical surface or even recessed.

Intellivox-H90 MKII

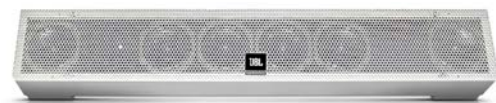

Intellivox-H90 MKII is designed for use on platforms and in high ceiling corridors, to minimise spill over a large bandwidth outside the listening area. The precisely defined horizontal dispersion aims the sound at the listener area, while minimising disturbance to other areas.

This dramatically reduces noise pollution to areas surrounding open platform railway stations; for instance the H90 column is designed to be mounted horizontally and can be mechanically aimed according to desired throw.

Intellivox around the world

Intellivox installations can now be found all over the world in a variety of applications including transport hubs, places of worship, parliaments, theatres, conference facilities, atriums and museums.

As well as offering maximum intelligibility through digital directivity technologies, Intellivox speakers are often more sensitive to the architecture of the space than conventional systems. When the architect, electro-acoustic consultant and installer work closely together the ultimate intelligibility and stunning visuals can be achieved simultaneously. In more innovative designs Intellivox units have been recessed into walls, placed inside custom built enclosures, housed within customer information displays, incorporated into theatrical scenery and in some cases have been hand painted by a scenic designer to perfectly match the surface on which they are being mounted. The Intellivox can be ordered in any colour and can even be coloured matched to a paint sample.





JBL Professional
8500 Balboa Boulevard
Northridge, CA 91329 U.S.A.

jblpro.com

New materials and design refinements are continually being introduced to our products. JBL Professional® reserves the right to make these changes without prior notification. As a logical consequence, present JBL Professional® systems may differ in some respect from those presented in this brochure, but will always meet or exceed published specifications, unless stated otherwise.

CAT-IVXFL0215-25

© Copyright 2016 JBL Professional