



Vista Compact Remote *SW Version 5.0*

For Your Own Safety and to Avoid Invalidation of the Warranty Please Read This Section Carefully

- Read these instructions.
- Keep these instructions.
- Heed all warnings.
- Follow all instructions.
- Do not use this apparatus near water.
- Clean only with a dry cloth.
- Do not block any ventilation openings. Install in accordance with the manufacturer's instructions.
- Do not install near any heat sources such as radiators, heat registers, stoves, or other apparatus (including amplifiers) that produce heat.
- Do not defeat the safety purpose of a polarised or grounding type plug. A polarised plug has two blades with one wider than the other. A grounding type plug has two blades and a third grounding prong. The wide blade or the third prong are provided for your safety. If the provided plug does not fit into your outlet, consult an electrician for replacement of the obsolete outlet.
- Protect the power cord from being walked on or pinched particularly at plugs, convenience receptacles and the point where they exit from the apparatus.
- Only use attachments/accessories specified by the manufacturer.
- Use only with the cart, stand, tripod, bracket or table specified by the manufacturer, or sold with the apparatus. When a cart is used, use caution when moving the cart/apparatus combination to avoid injury from tip-over.
- Refer all servicing to qualified service personnel. Servicing is required when the apparatus has been damaged in any way, such as the power supply cord or plug is damaged, liquid has been spilled or objects fallen into the apparatus, the apparatus has been exposed to rain or moisture, does not operate normally, or has been dropped.

Note: It is recommended that all maintenance and service on the product should be carried out by Studer or its authorised agents. Studer cannot accept any liability whatsoever for any loss or damage caused by service, maintenance or repair by unauthorised personnel.

WARNING: To reduce the risk of fire or electric shock, do not expose this apparatus to rain or moisture. Do not expose the apparatus to dripping or splashing and do not place objects filled with liquids, such as vases, on the apparatus.

- No naked flame sources, such as lighted candles, should be placed on the apparatus.
- Ventilation should not be impeded by covering the ventilation openings with items such as newspapers, table cloths, curtains etc.

WARNING: Do not use this apparatus in very dusty atmospheres, or in atmospheres containing flammable gases or chemicals.

- **THIS APPARATUS MUST BE EARTHED.** Under no circumstances should the safety earth be disconnected from the mains lead.
- The mains supply disconnect device is the mains plug. It must remain accessible so as to be readily operable when the apparatus is in use.
- If any part of the mains cord set is damaged, the complete cord set should be replaced. The following information is for reference only. The wires in the mains lead are coloured in accordance with the following code:

- **Protective Earth (Ground): Green/Yellow (US: Green or Green/Yellow)**
- **Neutral: Blue (US: White)**
- **Live (Hot): Brown (US: Black)**

As the colours of the wires in the mains lead may not correspond with the coloured markings identifying the terminals in your plug, proceed as follows:

- **The wire which is coloured Green and Yellow must be connected to the terminal in the plug which is marked with the letter E or by the earth symbol.**
- **The wire which is coloured Blue must be connected to the terminal in the plug which is marked with the letter N.**
- **The wire which is coloured Brown must be connected to the terminal in the plug which is marked with the letter L.**

Ensure that these colour codes are followed carefully in the event of the plug being changed

- **This unit is capable of operating over a range of mains voltages, as marked on the rear panel.**

Lithium Battery



Installed lithium batteries must be replaced by the same or an equivalent type. Danger of explosion if batteries are incorrectly replaced or when terminals are shorted.

Installed lithium batteries must not be exposed to excessive heat such as direct sunshine, fire or the like.

Note:

This equipment has been tested and found to comply with the limits for a Class A digital device, pursuant to Part 15 of the FCC Rules. These limits are designed to provide reasonable protection against harmful interference when the equipment is operated in a commercial environment. This equipment generates, uses and can radiate radio frequency energy and, if not installed and used in accordance with the instruction manual, may cause harmful interference to radio communications. Operation of this equipment in a residential area is likely to cause harmful interference in which case the user will be required to correct the interference at his own expense.

This Class A digital apparatus meets the requirements of the Canadian Interference-Causing Equipment Regulations.

Cet appareil numérique de la Classe A respecte toutes les exigences du Règlement sur le matériel brouilleur du Canada.

Working Safely With Sound

Although your new console will not make any noise until you feed it signals, it has the capability to produce sounds that, when monitored through a monitor system or headphones, can damage hearing over time. The table below is taken from the Occupational Safety & Health Administration directive on occupational noise exposure (1926.52):

Permissible Noise Exposure:



Duration per day [h]	Sound level [dBA, slow response]
8	90
6	92
4	95
3	97
2	100
1.5	102
1	105
0.5	110
<0.25	115

Conforming to this directive will minimise the risk of hearing damage caused by long listening periods. A simple rule to follow is: The longer you listen, the lower the average volume should be. Please take care when working with your audio system – if you are manipulating controls which you don't understand (which we all do when we are learning), make sure your monitoring level is turned down. *Remember that your ears are the most important tool of your trade. Look after them, and they will look after you. Most importantly: Don't be afraid to experiment to find out how each parameter affects the sound; this will extend your creativity and help you to get the best results.*

A1 Safety Symbol Guide



For your own safety and to avoid invalidation of the warranty, all text marked with these symbols should be read carefully.

To reduce the risk of electric shock, do not remove covers. No user-serviceable parts inside. Refer servicing to qualified service personnel (i.e., persons having appropriate technical training and experience necessary to be aware of hazards to which they are exposed in performing a repair action, and of measures to minimize the danger of themselves).

The lightning flash with arrowhead symbol is intended to alert the user to the presence of un-insulated “dangerous voltage” within the product’s enclosure that may be of sufficient magnitude to constitute a risk of electric shock to persons.



The exclamation point within an equilateral triangle is intended to alert the user to the presence of important operating and maintenance (servicing) instructions in the literature accompanying the appliance.



Headphones safety warnings contain important information and useful tips on headphone outputs and monitoring levels.

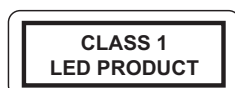

Assemblies or sub-assemblies of this product can contain opto-electronic devices. As long as these devices comply with Class I of laser or LED products according to EN 60825-1:1994, they will not be expressly marked on the product. If a special design should be covered by a higher class of this standard, the device concerned will be marked directly on the assembly or sub-assembly in accordance with the above standard.



A2 First Aid

In Case of Electric Shock:

Separate the person as quickly as possible from the electric power source:

- By switching the equipment off,
- By unplugging or disconnecting the mains cable, or
- By pushing the person away from the power source, using dry insulating material (such as wood or plastic).
- After having suffered an electric shock, always consult a doctor.

Warning!



Do not touch the person or his clothing before the power is turned off, otherwise you stand the risk of suffering an electric shock as well!

If the Person is Unconscious:

- Lay the person down
- Turn him to one side
- Check the pulse
- Reanimate the person if respiration is poor
- Call for a doctor immediately.

B General Installation Instructions

Please consider besides these general instructions also any product-specific instructions in the “Installation” chapter of this manual.

B1 Unpacking

Check the equipment for any transport damage. If the unit is mechanically damaged, if liquids have been spilled or if objects have fallen into the unit, it must not be connected to the AC power outlet, or it must be immediately disconnected by unplugging the power cable. Repair must only be performed by trained personnel in accordance with the applicable regulations.

B2 Installation Site

Install the unit in a place where the following conditions are met:

- The temperature and the relative humidity of the environment must be within the specified limits during operation of the unit. Relevant values are the ones at the air inlets of the unit (refer to Appendix 1).
- Condensation must be avoided. If the unit is installed in a location with large variation of ambient temperature (e.g. in an OB-van), appropriate precautions must be taken before and after operation (refer to Appendix 1).
- Unobstructed air flow is essential for proper operation. Air vents of the unit are a functional part of the design and must not be blocked in any way during operation (e.g. by objects placed upon them, placement of the unit on a soft surface, or installation of the unit within a rack or piece of furniture).
- The unit must not be heated up by external sources of heat radiation (sunlight, spotlights).

B3 Earthing and Power Supply

Earthing of units with mains supply (class I equipment) is performed via the protective earth (PE) conductor integrated in the mains cable. Units with battery operation (< 60 V, class III equipment) must be earthed separately. Earthing the unit is one of the measures for protection against electrical shock hazard (dangerous body currents). Hazardous voltage may not only be caused by a defective power supply insulation, but may also be introduced by the connected audio or control cables.

If the unit is installed with one or several external connections, its earthing must be provided during operation as well as while the unit is not operated. If the earthing connection can be interrupted, for example, by unplugging the mains plug of an external power supply unit, an additional, permanent earthing connection must be installed using the provided earth terminal.

Avoid ground loops (hum loops) by keeping the loop surface as small as possible (by consequently guiding the earth conductors in a narrow, parallel way), and reduce the noise current flowing through the loop by inserting an additional impedance (common-mode choke).

Class I Equipment (Mains Operation)

Should the equipment be delivered without a matching mains cable, the latter has to be prepared by a trained person using the attached female plug (IEC 320 / C13 or IEC 320 / C19) with respect to the applicable regulations in your country.

Before connecting the equipment to the AC power outlet, check that the local line voltage matches the equipment rating (voltage, frequency) within the admissible tolerance. The equipment fuses must be rated in accordance with the specifications on the equipment.

Equipment supplied with a 3-pole appliance inlet (protection conforming to class I equipment) must be connected to a 3-pole AC power outlet in such a way that the equipment cabinet is connected to the protective earth.

For information on mains cable strain relief, please refer to Appendix 2.

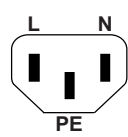
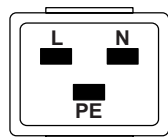
Female Plugs (IEC320), Front-Side View:		
 		
	IEC 320 / C13	IEC 320 / C19
European Standard (CENELEC)		North American Standard (NAS)
Brown	L (Live)	Black
Blue	N (Neutral)	White
Green/Yellow	PE (Protective Earth)	Green (or Green/Yellow)

Class III Equipment (Battery Operation up to 60 VDC)

Equipment of this protection class must be earthed using the provided earth terminal if one or more external signals are connected to the unit (see explanation at the beginning of this paragraph).

B4 Electromagnetic Compatibility (EMC)

The unit conforms to the protection requirements relevant to electromagnetic phenomena that are listed in guidelines 89/336/EC and FCC, part 15.

- The electromagnetic interference generated by the unit is limited in such a way that other equipment and systems can be operated normally.
- The unit is adequately protected against electromagnetic interference so that it can operate properly.

The unit has been tested and conforms to the EMC standards of the specified electromagnetic environment, as listed in the following declaration. The limits of these standards ensure protection of the environment and corresponding noise immunity of the equipment with appropriate probability. However, a professional installation and integration within the system are imperative prerequisites for operation without EMC problems.

For this purpose, the following measures must be followed:

- Install the equipment in accordance with the operating instructions. Use the supplied accessories.
- In the system and in the vicinity where the equipment is installed, use only components (systems, equipment) that also fulfill the EMC standards for the given environment.

- Use a system grounding concept that satisfies the safety requirements (class I equipment must be connected with a protective ground conductor) and that also takes into consideration the EMC requirements. When deciding between radial, surface, or combined grounding, the advantages and disadvantages should be carefully evaluated in each case.
- Use shielded cables where shielding is specified. The connection of the shield to the corresponding connector terminal or housing should have a large surface and be corrosion-proof. Please note that a cable shield connected only single-ended can act as a transmitting or receiving antenna within the corresponding frequency range.
- Avoid ground loops or reduce their adverse effects by keeping the loop surface as small as possible, and reduce the noise current flowing through the loop by inserting an additional impedance (e.g. common-mode choke).
- Reduce electrostatic discharge (ESD) of persons by installing an appropriate floor covering (e.g. a carpet with permanent electrostatic filaments) and by keeping the relative humidity above 30%. Further measures (e.g. conducting floor) are usually unnecessary and only effective if used together with corresponding personal equipment.
- When using equipment with touch-sensitive operator controls, please take care that the surrounding building structure allows for sufficient capacitive coupling of the operator. This coupling can be improved by an additional, conducting surface in the operator's area, connected to the equipment housing (e.g. metal foil underneath the floor covering, carpet with conductive backing).

C Maintenance

All air vents and openings for operating elements (faders, rotary knobs) must be checked on a regular basis, and cleaned in case of dust accumulation. For cleaning, a soft paint-brush or a vacuum cleaner is recommended. Cleaning the surfaces of the unit is performed with a soft, dry cloth or a soft brush.

Persistent contamination can be treated with a cloth that is slightly humidified with a mild cleaning solution, such as dishwashing detergent.

For cleaning display windows, commercially available computer/TV screen cleaners are suited. Use only a slightly damp (never wet) cloth.

Never use any solvents for cleaning the exterior of the unit! Liquids must never be sprayed or poured on directly!

For equipment-specific maintenance information please refer to the corresponding chapter in the operating and service manuals.

D Electrostatic Discharge during Maintenance and Repair

Caution:



Observe the precautions for handling devices sensitive to electrostatic discharge!

Many semiconductor components are sensitive to electrostatic discharge (ESD). The lifespan of assemblies containing such components can be drastically reduced by improper handling during maintenance and repair. Please observe the following rules when handling ESD sensitive components:

- ESD sensitive components should only be stored and transported in the packing material specifically provided for this purpose.

- When performing a repair by replacing complete assemblies, the removed assembly must be sent back to the supplier in the same packing material in which the replacement assembly was shipped. If this should not be the case, any claim for a possible refund will be null and void.
- Unpacked ESD sensitive components should only be handled in ESD protected areas (EPA, e.g. area for field service, repair or service bench) and only be touched by persons wearing a wristlet connected to the ground potential of the repair or service bench by a series resistor. The equipment to be repaired or serviced as well as all tools and electrically semi-conducting work, storage, and floor mats should also be connected to this ground potential.
- The terminals of ESD sensitive components must not come in uncontrolled contact with electrostatically chargeable or metallic surfaces (voltage puncture, discharge shock hazard).
- To prevent the components from undefined transient stress and possible damage due to inadmissible voltages or compensation currents, electrical connections should only be established or separated when the equipment is switched off and after any capacitor charges have decayed.

E Repair

By removing housing parts or shields, energized parts may be exposed. For this reason the following precautions must be observed:

- Maintenance may only be performed by trained personnel in accordance with the applicable regulations.
- The equipment must be switched off and disconnected from the AC power outlet before any housing parts are removed.
- Even if the equipment is disconnected from the power outlet, parts with hazardous charges (e.g. capacitors, picture tubes) must not be touched until they have been properly discharged. Do not touch hot components (power semiconductors, heat sinks, etc.) before they have cooled off.
- If maintenance is performed on a unit that is opened while being switched on, no un-insulated circuit components and metallic semiconductor housings must be touched, neither with bare hands nor with un-insulated tools.

Certain components pose additional hazards:

- Explosion hazard from lithium batteries, electrolytic capacitors and power semiconductors (Observe the component's polarity. Do not short battery terminals. Replace batteries only by the same type).
- Implosion hazard from evacuated display units.
- Radiation hazard from laser units (non-ionizing), picture tubes (ionizing).
- Caustic effect of display units (LCD) and components containing liquid electrolyte.

Such components should only be handled by trained personnel who are properly protected (e.g. protection glasses, gloves).

E1 SMD Components

Studer has no commercially available SMD components in stock for service purposes. For repair, the corresponding devices have to be purchased locally. The specifications of special components can be found in the service manual. SMD components should only be replaced by skilled specialists using appropriate tools. No warranty claims will be accepted for circuit boards that have been damaged. Proper and improper SMD soldering joints are illustrated below.

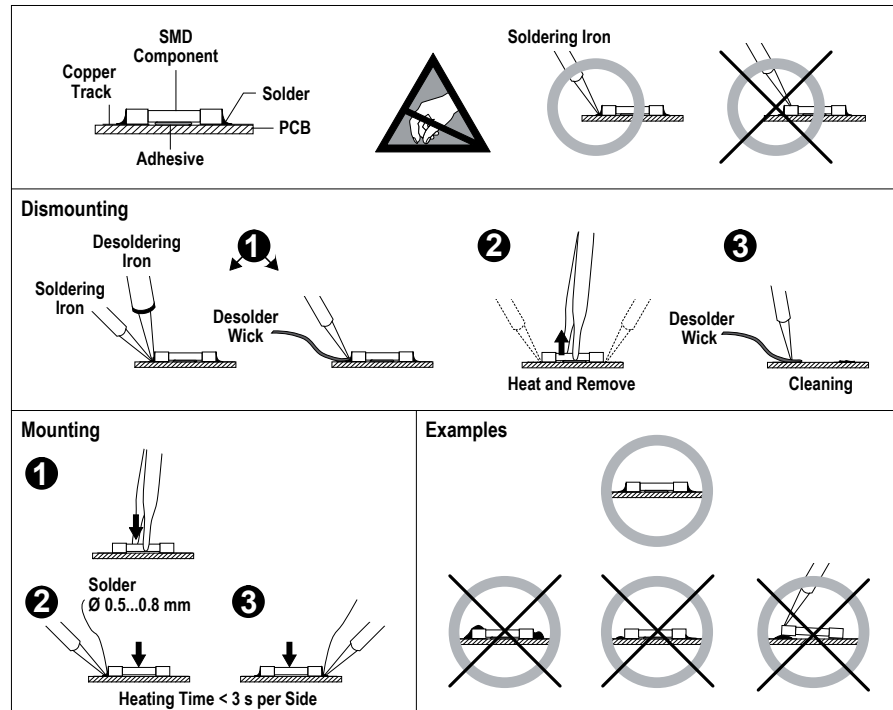

F Disposal

Packing Materials

The packing materials have been selected with environmental and disposal issues in mind. All packing material can be recycled. Recycling packing saves raw materials and reduces the volume of waste. If you need to dispose of the transport packing materials, please try to use recyclable means.

Used Equipment

Used equipment contains valuable raw materials as well as materials that must be disposed of professionally. Please return your used equipment via an authorized specialist dealer or via the public waste disposal system, ensuring any material that can be recycled is. Please take care that your used equipment cannot be abused. To avoid abuse, delete sensitive data from any data storage media. After having disconnected your used equipment from the mains supply, make sure that the mains connector and the mains cable are made useless.

G Declarations of Conformity

G1 Class A Equipment - FCC Notice

This equipment has been tested and found to comply with the limits for a Class A digital device, pursuant to Part 15 of the FCC Rules. These limits are designed to provide a reasonable protection against harmful interference when the equipment is operated in a commercial environment. This equipment generates, uses, and can radiate radio frequency energy and, if not installed and used in accordance with the instruction manual, may cause harmful interference to radio communications. Operation of this equipment in a residential area is likely to cause harmful interference, in which case the user will be required to correct the interference at his own expense.

Caution: *Any changes or modifications not expressly approved by the manufacturer could void the user's authority to operate the equipment. Also refer to relevant information in this manual.*

G2 CE Declaration of Conformity

We,
**Studer Professional Audio GmbH,
CH-8105 Regensdorf,**
declare under our sole responsibility that the product
**Studer Vista Compact Remote
(from serial no. 1000),**
to which this declaration relates, according to following regulations of EU directives and amendments

- Low Voltage (LVD):
73/23/EEC + 93/68/EEC
- Electromagnetic Compatibility (EMC):
89/336/EEC + 92/31/EEC + 93/68/EEC

are in conformity with the following standards or normative documents:

- Safety:
EN 60950-1:2001 (Class I equipment)
- Safety of laser products:
EN 60825-1:2004 + A11 + A2, EN60825-2:2000

Regensdorf, October 21, 2013



B. Hochstrasser, President



M. Lienert, Manager R&D

Appendix 1: Air Temperature and Humidity

General

Normal operation of the unit or system is warranted under the ambient conditions defined by *EN 60721-3-3, set IE32, value 3K3*.

This standard consists of an extensive catalogue of parameters, the most important of which are: ambient temperature +5...+40 °C, relative humidity 5...85% (i.e., no formation of condensation or ice); absolute humidity 1...25 g/m³; rate of temperature change < 0.5 °C/min. These parameters are dealt with in the following paragraphs.

Under these conditions the unit or system starts and works without any problem. Beyond these specifications, possible problems are described below.

Ambient Temperature

Units and systems by Studer are generally designed for an ambient temperature range (i.e. temperature of the incoming air) of +5 °C to +40 °C. When rack mounting the units, the intended air flow and herewith adequate cooling must be provided. The following facts must be considered:

- The admissible ambient temperature range for operation of the semiconductor components is 0 °C to +70 °C (commercial temperature range for operation).
- The air flow through the installation must provide that the outgoing air is always cooler than 70 °C.
- Average heat increase of the cooling air shall be about 20 K, allowing for an additional maximum 10 K increase at the hot components.
- In order to dissipate 1 kW with this admissible average heat increase, an air flow of 2.65 m³/min is required.

Example: A rack dissipating $P = 800 \text{ W}$ requires an air flow of $0.8 * 2.65 \text{ m}^3/\text{min}$ which corresponds to $2.12 \text{ m}^3/\text{min}$.

- If the cooling function of the installation must be monitored (e.g. for fan failure or illumination with spot lamps), the outgoing air temperature must be measured directly above the modules at several places within the rack. The trigger temperature of the sensors should be 65 °C to 70 °C.

Frost and Dew

The unsealed system parts (connector areas and semiconductor pins) allow for a minute formation of ice or frost. However, formation of dew visible to the naked eye will already lead to malfunctions. In practice, reliable operation can be expected in a temperature range above -15 °C, if the following general rule is considered for putting the cold system into operation:

If the air within the system is cooled down, the relative humidity rises. If it reaches 100%, condensation will arise, usually in the boundary layer between the air and a cooler surface, together with formation of ice or dew at sensitive areas of the system (contacts, IC pins, etc.). Once internal condensation occurs, trouble-free operation cannot be guaranteed, independent of temperature.

Before putting into operation, the system must be checked for internal formation of condensation or ice. Only with a minute formation of ice, direct

evaporation (sublimation) may be expected; otherwise the system must be heated and dried while switched off.

A system without visible internal formation of ice or condensation should be heated up with its own heat dissipation, as homogeneously (and subsequently as slow) as possible; the ambient temperature should then always be lower than the one of the outgoing air.

If it is absolutely necessary to operate the cold system immediately within warm ambient air, this air must be dehydrated. In such a case, the absolute humidity must be so low that the relative humidity, related to the coldest system surface, always remains below 100%.

Ensure that the enclosed air is as dry as possible when powering off (i.e. before switching off in winter, aerate the room with cold, dry air, and remove humid objects such as clothes from the room).

These relationships are visible from the following climatogram. For a controlled procedure, thermometer and hygrometer as well as a thermometer within the system will be required.

Example 1: An OB-van having an internal temperature of +20 °C and a relative humidity of 40% is switched off in the evening. If the temperature falls below +5 °C, the relative humidity will rise to 100% (7 g/m³); dew or ice will be forming.

Example 2: An OB-van is heated up in the morning with air of +20 °C and a relative humidity of 40%. On all parts being cooler than +5 °C, dew or ice will be forming.

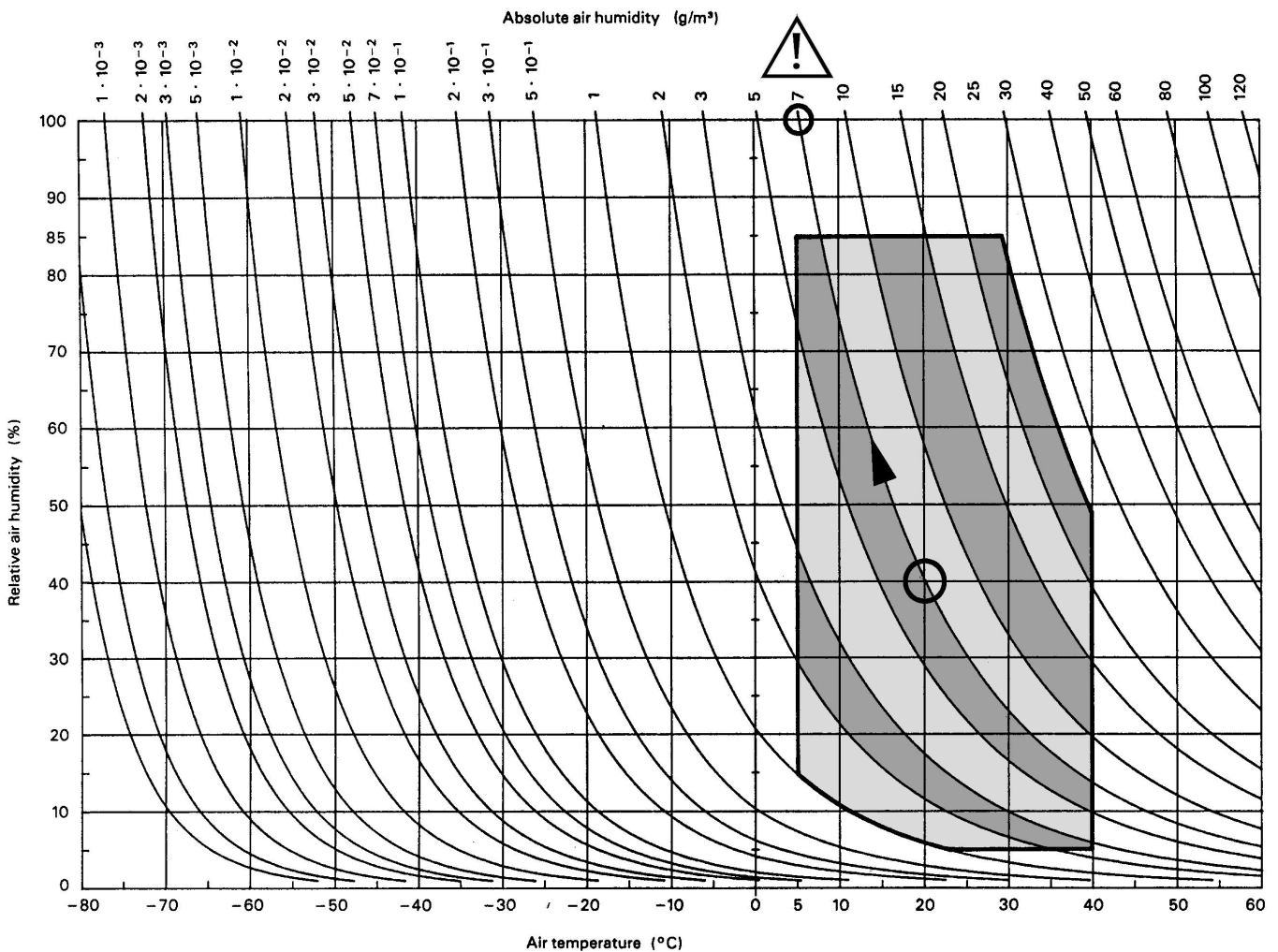

Appendix 2: Mains Connector Strain Relief

For anchoring connectors without a mechanical lock (e.g. IEC mains connectors), we recommend the following arrangement:

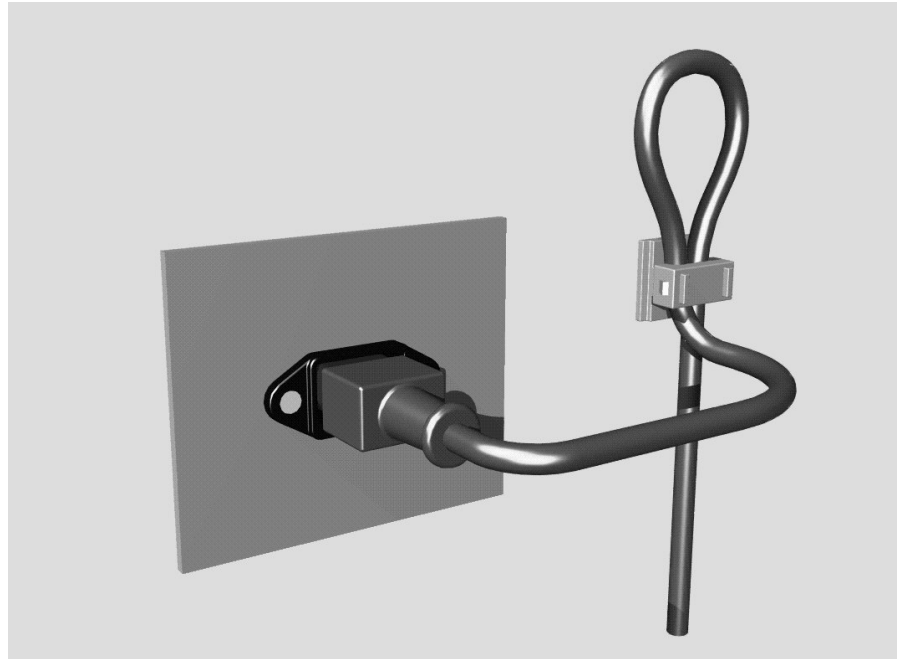

Procedure: The cable clamp shipped with your unit is auto-adhesive. For mounting please follow the rules below:

- The surface to be adhered to must be clean, dry, and free from grease, oil, or other contaminants. Recommended application temperature range is +20 °C to +40 °C.
- Remove the plastic protective backing from the rear side of the clamp and apply it firmly to the surface at the desired position. Allow as much time as possible for curing. The bond continues to develop for as long as 24 hours.
- For improved stability, the clamp should be fixed with a screw. For this purpose, a self-tapping screw and an M4 bolt and nut are included.
- Place the cable into the clamp as shown in the illustration above and firmly press down the internal top cover until the cable is fixed.

Appendix 3: Software License

Use of the software is subject to the Studer Professional Audio Software License Agreement set forth below. Using the software indicates your acceptance of this license agreement. If you do not accept these license terms, you are not authorized to use this software.

Under the condition and within the scope of the following Terms and Conditions, Studer Professional Audio GmbH (hereinafter ‘Studer’) grants the right to use programs developed by Studer as well as those of third parties which have been installed by Studer on or within its products. References to the license programs shall be references to the newest release of a license program installed at the Customer’s site.

Programs Covered by the Agreement

License Programs of Studer The following Terms and Conditions grant the right to use all programs of Studer that are part of the System and/or its options at the time of its delivery to the Customer, as well as the installation software on the original data disk and the accompanying documentation (‘License Material’). In this Agreement the word ‘Programs’ shall have the meaning of programs and data written in machine code.

Using the software indicates your acceptance of this license agreement. If you do not accept these license terms, you are not authorized to use this software.

Programs of Third Parties Programs of third parties are all programs which constitute part of the System and/or its options at the time of delivery to the Customer but have not been developed by Studer. The following conditions are applicable to programs of third parties:

- The right to use third parties’ programs is governed by the License Agreement attached hereto (if applicable), which is an integral part of this Agreement. The Customer shall sign any and all License Agreements for all further programs of third parties installed on the system. The Customer shall be deemed to have received all License Agreements upon delivery of the system and/or its options.
- Studer shall accept no responsibility or liability for, and gives no warranties (express or implied) as to the programs of third parties. The Customer waives any and all claims versus Studer for any consequential damages, which might occur due to defects of these programs.

Right of Use

Principle Studer grants the Customer the non-exclusive right to use the License Material in one copy on the system and/or its options as laid down by the Sales Agreement concluded between the parties and all Terms and Conditions which shall be deemed to form and be read and construed as part of the Sales Agreement. This right is assignable according to the ‘Assignability’ paragraph hereinafter.

Customized Configurations The Customer is not entitled to alter or develop further the License Material except within the expressly permitted configuration possibilities given by the software installed on the system or elsewhere. All altered programs, including but not limited to the products altered within the permitted configuration possibilities, are covered by this License Agreement.

- Reverse Engineering** Reverse engineering is only permitted with the express consent of Studer. The consent of Studer can be obtained but is not limited to the case in which the interface software can not be provided by Studer. In any case Studer has to be informed immediately upon complete or partial reverse engineering.
- Copying the License Material** The Customer is entitled to make one copy of all or parts of the License Material as is necessary for the use according to this Agreement, namely for backup purposes. The Customer shall apply the copyright of Studer found on the License Material onto all copies made by him. Records shall be kept by the Customer regarding the amount of copies made and their place of keeping. The responsibility for the original program and all copies made lies with the Customer. Studer is entitled to check these records on first request. Copies not needed anymore have to be destroyed immediately.
- Disclosure of License Material** The License Material is a business secret of Studer. The Customer shall not hand out or in any way give access to parts of or the complete License Material to third parties nor to publish any part of the License Material without prior written consent of Studer. The Customer shall protect the License Material and any copies made according to the paragraph above by appropriate defense measures against unauthorized access. This obligation of non-disclosure is a perpetual obligation.
Third parties are entitled to have access to the License Material if they use the License Material at the Customer's site in compliance with this Agreement. Under no circumstance are third parties entitled to have access to the installation software on the original data media. The Customer shall safeguard the original data media accordingly.
- Assignability** The rights granted to the Customer according to this License Agreement shall only be assignable to a third party together with the transfer of the system and/or its options and after the prior written consent of Studer.

Rights to License Material

With the exception of the right of use granted by this License Agreement all proprietary rights to the License Material, especially the ownership and the intellectual property rights (such as but not limited to patents and copyright) remain with Studer even if alterations, customized changes or amendments have been made to the License Material.

Studer's proprietary rights are acknowledged by the Customer. The Customer shall undertake no infringements and make no claims of any patent, registered design, copyright, trade mark or trade name, or other intellectual property right.

Warranty, Disclaimer, and Liability

For all issues not covered herewithin, refer to the 'General Terms and Conditions of Sales and Delivery' being part of the sales contract.

CONTENTS

1 Introduction.....4

1.1 Hardware description.....4

1.2 Buttons and desk controls.....6

1.3 Connectors.....9

1.4 Illumination10

1.5 Applications.....10

2 Operation modes..... 11

2.1 „With Desk“12

2.2 „With Desk + Core“17

2.3 „With Core“20

2.4 „Offline“23

3 Operation.....24

3.1 Strip Setup24

3.2 Navigation26

3.3 Copy and Paste27

3.4 Monitoring.....28

3.5 Tips and tricks31

4 Functional Differences between Compact Remote and Desk 32
when online with Desk (with SW v5.0) 32

4.1 Blackout Event in CueList32

4.2 Channel Settings Library.....32

4.3 CGM/VCA Setup32

4.4 Conferencing32

4.5 Dynamic Automation32

4.6 Faderglow™32

4.7 Vista FX.....32

4.8 GEQ.....32

4.9 Library Events33

4.10 Mute Groups.....33

4.11 N-1 Assign dialog.....33

4.12 Partial Snapshots33

4.13 Relink33

4.14	Signaling.....	33
4.15	Talkback	33
4.16	User Keys	33
4.17	User\Vista Settings	34
5	Specifications.....	34

1 Introduction



1.1 Hardware description

The STU-12 Vista Compact Remote (Compact Remote) is a small, portable 12-fader box.

It runs the Virtual Vista software – exactly the same software application that can be used for offline editing and online control of Vista consoles on a laptop computer.

As it runs the Virtual Vista application, it is nothing else than a hardware controller for the Virtual Vista!

So if you have used a Virtual Vista before, you are already familiar with most of the Compact Remote.

The unit is foldable, similar to a laptop computer. It consists of a control surface section with 12 high-quality, motorised Penny&Giles faders, 40 rotary controls, channel metering, channel Mute-, PFL-, Contrib-and Talk buttons, a touch pad and a slide-in keyboard.

The main operation-element is the foldable 19" touch screen.

All navigation and control buttons available with the Virtual Vista application can be operated via the touch screen, instead of using the touch pad or a mouse.

The large touch screen can be folded down, thus protecting both screen and control hardware during transport and, at the same time, considerably reducing the unit's size.

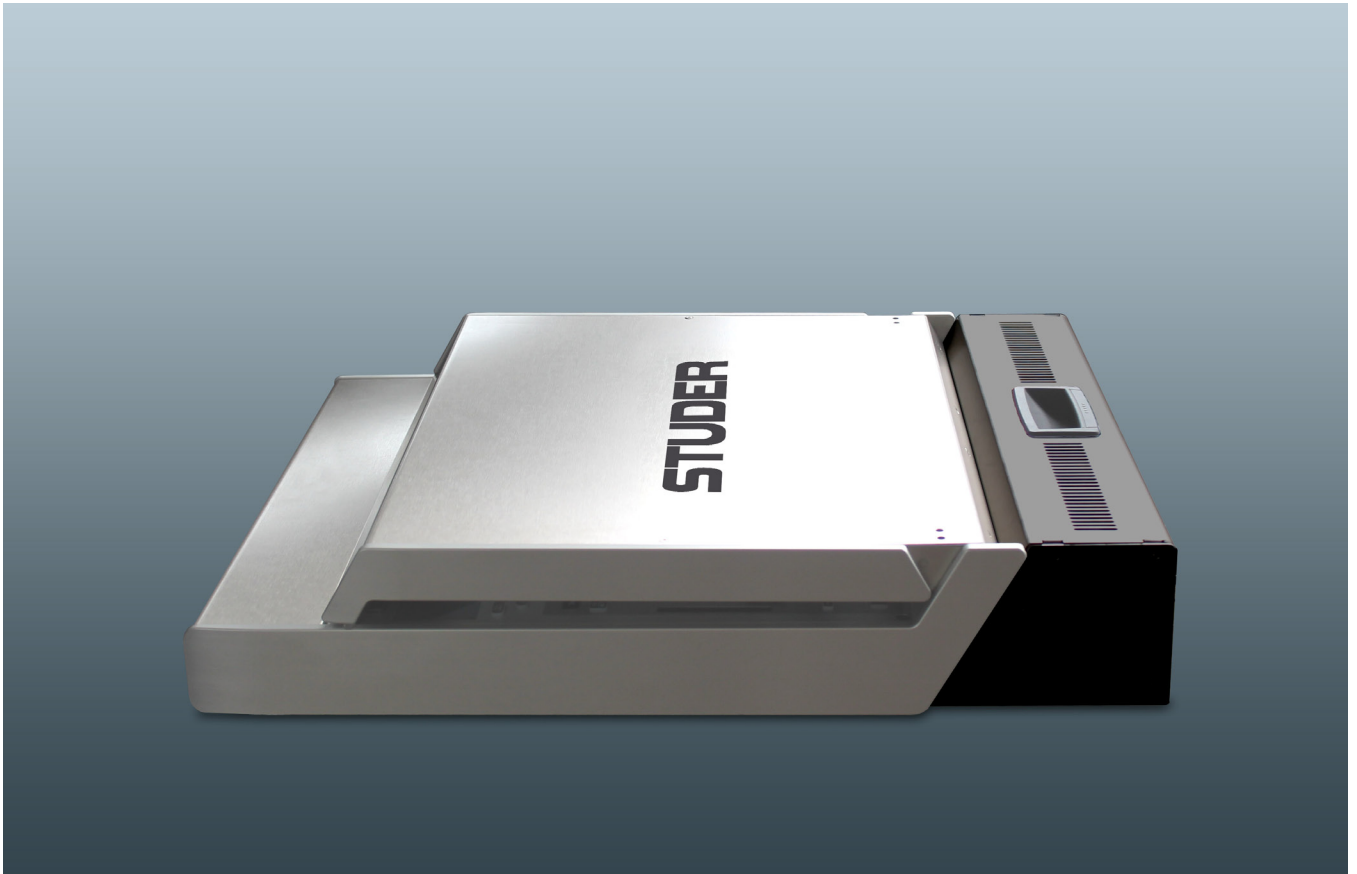

1.2 Buttons and desk controls

Left hand side



ON / OFF The „On/Off“ button underneath the TB-mic XLR input socket is flashing as soon as the mains switch on the inlet socket is switched on. Pressed once, the Compact Remote starts booting. If it is pressed for two seconds or longer, the Compact Remote will close the Virtual Vista application and shut the OS down and then the power down the unit.

VIRTUAL Navigates to the main screen of the Virtual Vista application to show the desk emulation, therefore making all audio parameters accessible on the touch screen.

GC Navigates to the GC screen (graphical controller) of the Virtual Vista. Since quick swapping from GC to desk parameters is often required, the use of these two navigation buttons is speeding up swapping - even though the two buttons are also available on the GC screen and bay emulation, where they can be operated by mouse or touch screen.

MON Switches to the monitoring section and shows the virtual monitoring page on the touch screen.

HEADPHONE Potentiometer used to adjust the level of the headphone output.

Note : This potentiometer controls the Compact Remote’s internal analog headphone amplifier. Working online with Vista 9 systems, the headphone level is also depending on the digital headphone level control, which can be found on the virtual monitoring page of the Compact Remote, or on the desk surface itself.

MON LEVEL This assignable potentiometer controls the monitoring levels of the monitoring outputs which are selected by the three buttons underneath it :

CR Assigns the level control to the control room monitoring speakers.

ST A Assigns the level control to the Studio A monitoring speakers.

ST B Assigns the level control to the Studio B monitoring speakers.

CUELIST Opens the Cue List page of the GC.

XFAD Activates the crossfade option in the cue list.

PREVIEW Activates the snapshot preview mode.

PREV Fires the cue previous to the currently active cue.

NEXT Fires the cue next to the currently active cue.

Note : the PREV and NEXT buttons are only active while the cue list is armed.

Channel strip



Four Vistonics rotaries and push-buttons are mapped to the parameters that are shown in the Virtual Vista (touch screen) on the corresponding channel strip.

Note : The Vistonics rotaries and push-buttons also control the mapped parameters even if the parameters are not shown on the touch screen – e.g. after navigating to a GC page or to the monitoring page.

- CONTRIB** Shows the contribution of this channel.
- MUTE** Channel-mute.
- TALK** Channel talk button.
- FADER** Channel fader.
- METER** Shows the channel metering as well as the CGM/VCA-assign number.
- LINK/SEL** Link/select button.
- PFL** Channel PFL button.

Right hand side

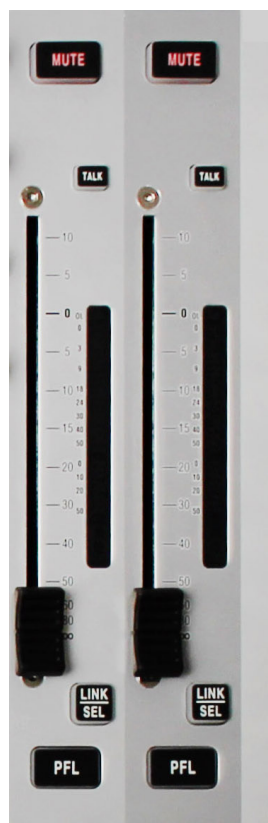

These two channel strips always control the Grand Master faders. These faders are always active, no matter which bay is selected on the touch-screen.

MUTE Grand Master Channel-mute.

TALK Grand Master Channel talk button.

FADER Channel fader.

METER Shows the channel metering as well as the CGM/VCA-assign number.

LINK/SEL Link/select button.

PFL Channel PFL button.



SNAPSHOT Navigates to the Snapshot page on the GC.

GENERAL PATCH Navigates to the General Patch page on the GC.

STRIP SETUP Shows the Strip Setup.

CLIPBOARD LIBRARY Shows the Clipboard Library window.

CHANNEL PATCH Navigates to the Channel Patch page on the GC.

The touchpad as well as the left- and the right mouse button allow cursor control and navigation on the GC- and Virtual Vista screen .

1.3 Connectors

On the rear of the unit, a large number of connectors are available :

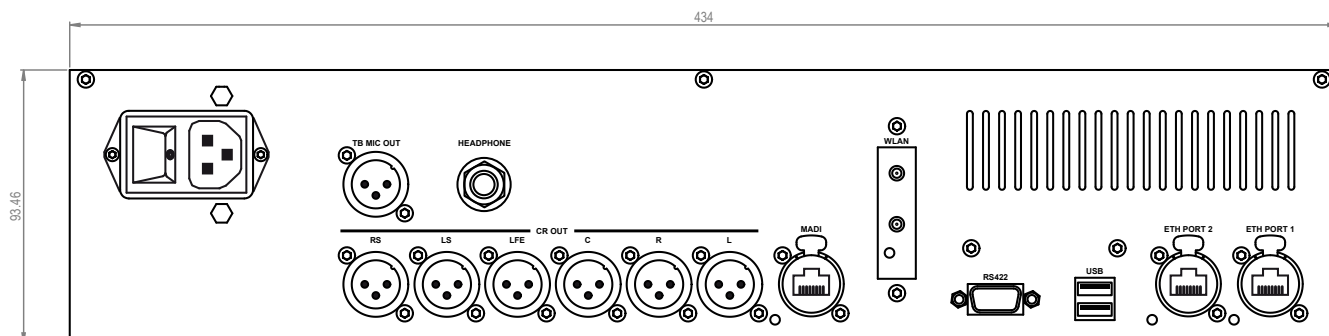

- MAINS** IEC 320/C14 power inlet (80-240 VAC) with integrated switch
- USB** 2 × USB (e.g. for a mouse or a memory stick)
- ETH PORT 1** Ethernet port 1 (for remote control of the desk in online mode)
- ETH PORT 2** Ethernet port 2 (for connecting to the second Bridge Card port in desk redundancy mode and SCoreLive DSP control take-over)
- RS422** RS422 port (e.g. for ProBel and other third party protocol control)
- WLAN** WLAN antenna sockets
- MADI** MADI (for PFL- and monitoring signals , for Vista 5 and Vista 9 only)
- CR OUT** • 6 × XLR (CR monitoring outputs, for Vista 5 and Vista 9 only)
- TB MIC OUT** • 1 × XLR (TB mic out socket - straight through from front panel input)
- HEADPHONE** • Headphone output

There is an additional USB port, next to the keyboard in the slide-in drawer.



1.4 Illumination

Above the touch screen, four desk illumination slots with two LED's each can be found .



The brightness of the illumination can be set in the vista settings-menu and ranges from 1 (off) to 6 (maximum)

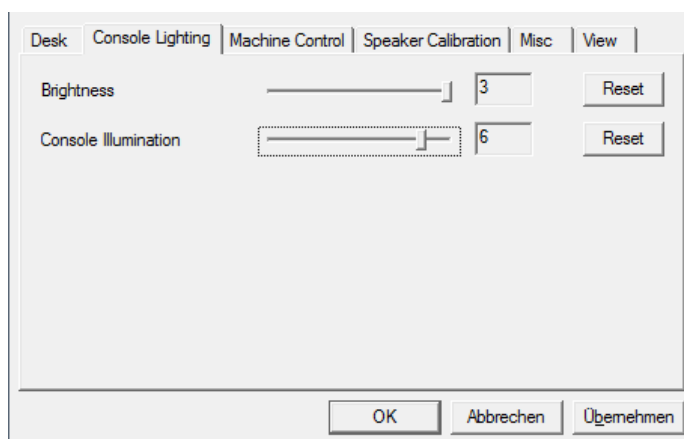

1.5 Applications

The Vista Compact Remote is very versatile, and has a very wide range of uses – the most obvious applications are the following ones :

- Remote bay with minimal footprint (online with any Vista console)
- Portable Desk that can be placed anywhere in the theatre auditorium for rehearsals
- Redundant VCA-style fader box in theatres
- Redundant desk for OB Trucks

The Compact Remote provides full control of all desk parameters and some basic monitoring functionality. It can be used with all types of Vista consoles. It can also be used as a remote control for the all-in-one Vista 1 console. In addition it may also be used as a completely stand-alone controller for Vista SCoreLive based systems, should the control surface not be available – or not be portable enough for the location of a specific production.

2 Operation modes

Depending on the customers needs, the Vista Compact Remote can be used in four different operation modes :

- „With Desk“
- „With Desk + Core“
- „With Core“
- „Offline“

Each one of these modes needs a different configuration as well as a different connection setup. -> The configuration is all contained in the Compact Remote's **D950System.ini** file, which can be found on the **C:\D950system** folder of it's **C:** drive.

Identical SW versions required !

The Compact Remote and the Vista desk must run the same Version of Vista - respectively Virtual Vista software.

If started online with non-identical SW versions, the following error message appears and Virtual Vista will not start.

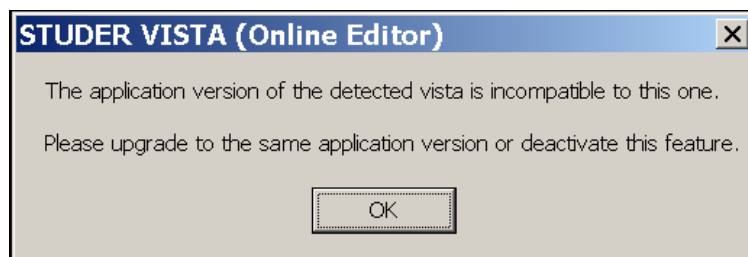

When working offline it is recommended to always use identical SW versions - to ensure compatibility of titles and snapshots

2.1 „With Desk“

This operation mode describes how the Compact Remote is connected to a Vista desk, so that it can work online with the desk.

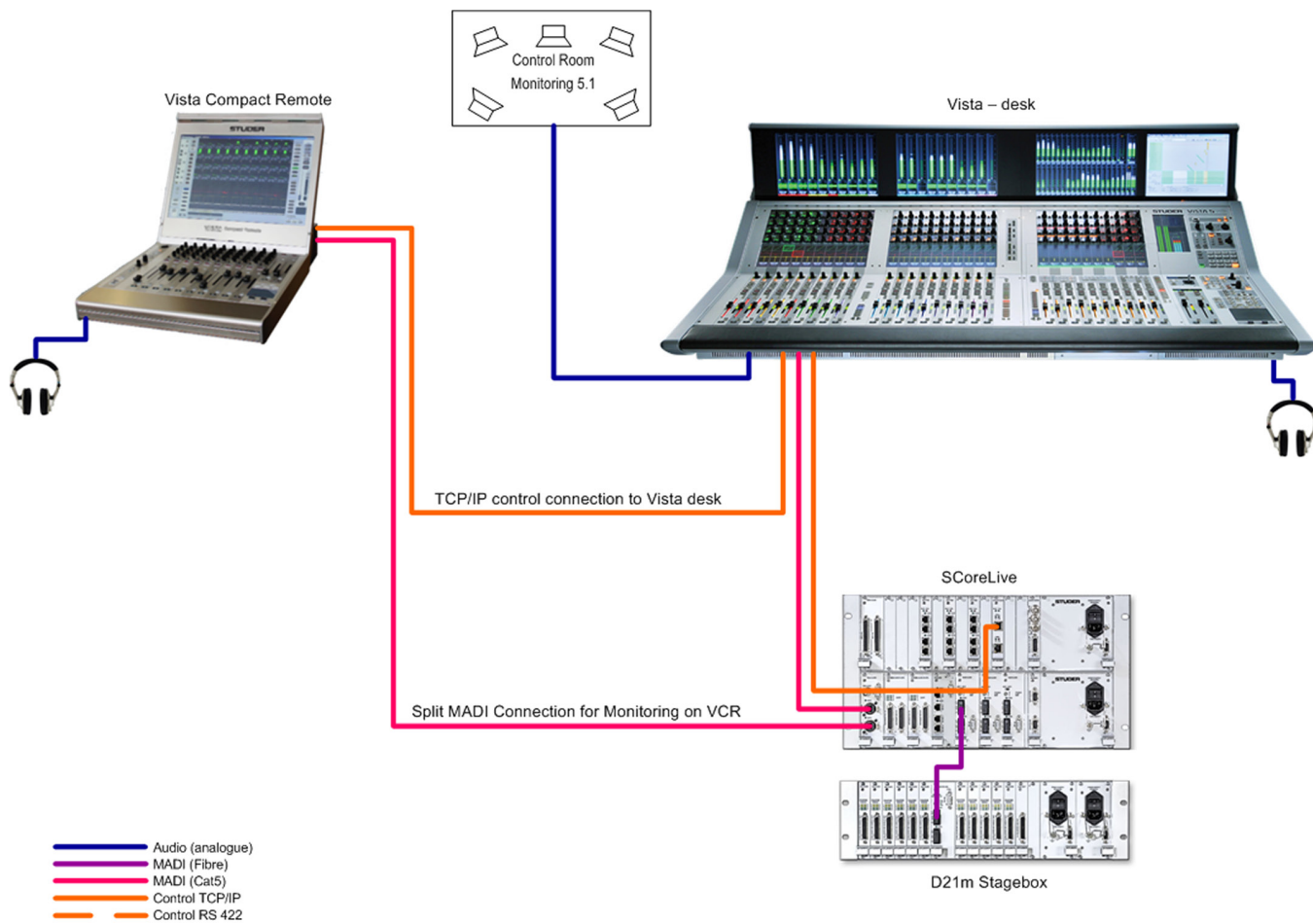

How does the Compact Remote control the main desk, and in the end the mixing console parameters?

When the Compact Remote is online with a desk, the Virtual Vista which runs on the Compact Remote allows to remote-control the desk. Therefore it gets connected to the Vista application that runs on the desk and allows the Compact Remote to remote control all audio parameters. It is important to understand that the Vista application on the desk "is" the real mixing console, and therefore the instance that communicates with the DSP engine! As long as the Compact Remote is connected to the desk, it can remote control it. When the connection is lost (e.g. due to weak WLAN or when the Compact Remote is shut down), the Vista desk doesn't bother and keeps on running and communicating to the DSP engine. The Compact Remote is free to reconnect at any time to the desk again, without the need to restart the whole system.

When the Compact Remote is online with the desk, and the Vista application on the desk is stopped, the Compact Remote also immediately loses control of the audio parameters. This is because its counterpart - the Vista application on the desk - is not running. So even though a Compact Remote is connected to a desk, it is always the Vista desk which controls the DSP engine.

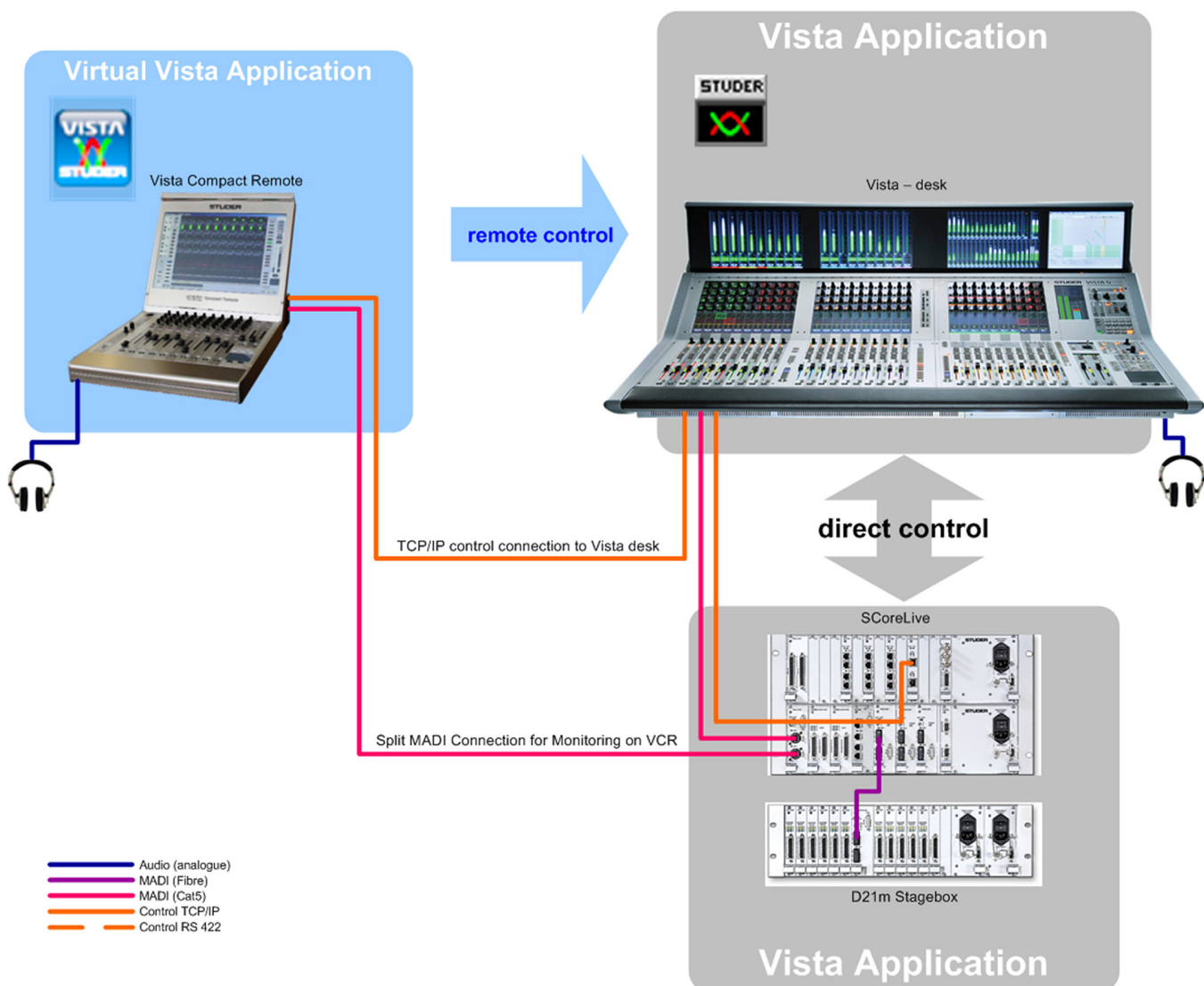

GC (Graphical controller or “Main screen”)

Therefore it is clear, that also all GC functionality of the Vista desk needs to be remote controlled from the Compact Remote. This is achieved by actually not showing the Virtual Vista’s GC but by displaying the desk’s GC via a remote desktop connection. It is a simple and safe way of controlling the desks GC. When the Compact Remote is started offline, it shows its own GC screen, but when it is started online with a desk, it shows the desks GC. This remote desktop connection is established with tightVNC – where a tightVNC server is installed on every Vista desk – and the tightVNC viewer is installed on the Compact Remote.

It is noticeable during the startup-process of the Virtual Vista on the Compact Remote, that firstly the Virtual Vista’s own GC screen is shown, but later on, when the connection to the online desk has been established, the Virtual Vista’s GC screen disappears and the desks’ GC screen is shown via tightVNC window. Also when an online connection to a desk is suddenly interrupted (e.g. due to a bad wlan connection), the vnc-window disappears, and the Virtual Vista’s own GC appears again.

Start-up

To get online with the Vista desk, the Virtual Vista on the Compact Remote should only be started when the Vista desk is already running and has completed it’s startup procedure, resulting in a green dot of the surveyor.

If the ini files of both (Compact Remote and Vista desk) are configured properly, the online startup window appears on the screen of the Compact Remote.

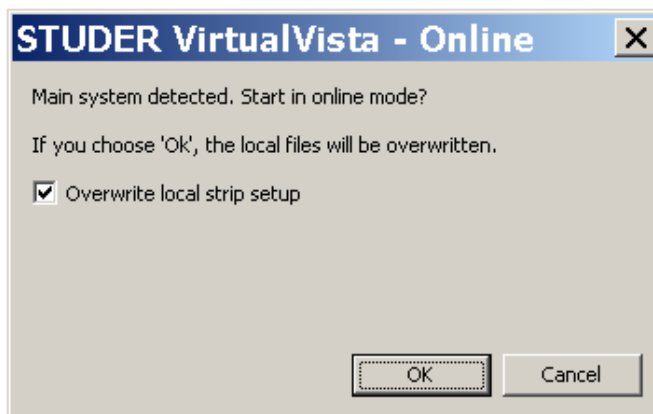

The clicking on either button now decides whether the Compact Remote goes online with the desk, or whether it starts offline. Going online with the Vista desk also implies, that all Vista desks production data gets copied over to the Compact Remote. All this data is stored in the Compact Remote’s directory **C:\backup**

Once the Compact Remote has fully started, the online status indicator shows that a „Desk“ is online. In this operation mode, the button „Connect to Core“ has no function.



Configuration

This operation mode requires a network connection from the Compact Remote to the Vista desk. If PFL monitoring on the headphone output of the Compact Remote is needed, also the MADI connection from the system rack to the Compact Remote is necessary.

The network connection to the Vista desk can also be established via wireless LAN; in this case a wlan router needs to be connected on the Vista desks side.

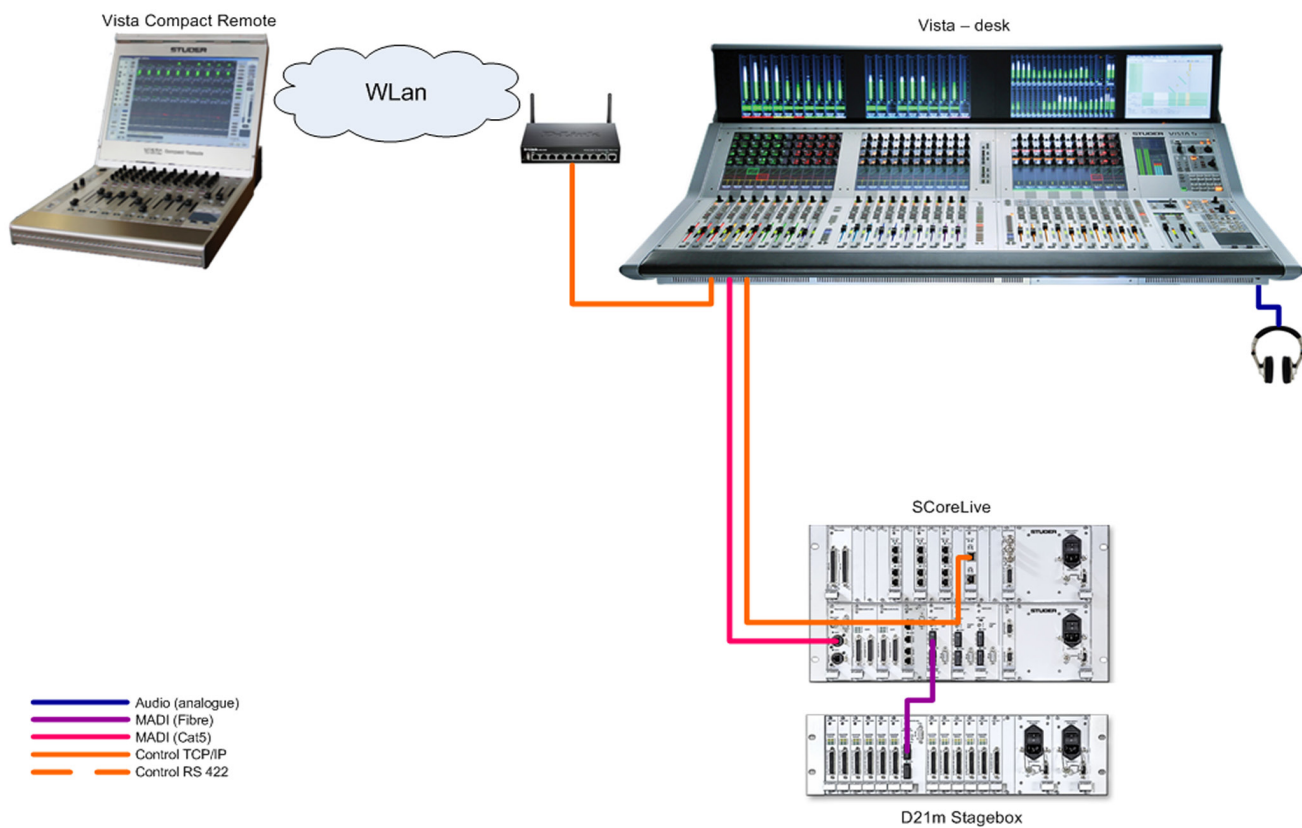

Ini file on Compact Remote

The following entries in the Compact Remote's **D950system.ini** file are required to configure the system for this operation mode :

```
; ***** Emulation / RemoteControl (VirtualVista) *****
EmulationEnabled=Yes
EmulationBayCount=3
EmulationControlbayPosition=3

EmulationEnabled=Yes
EmulationBayCount=5 <- desired number of emulated desk bays
EmulationControlbayPosition=3 <- desired position of the emulated controlbay
RemoteControlEnabled=Yes
RemoteControlHost=192.168.2.128 <- IP Address of desks network port – where the Compact Remote is connected to
RemoteControlPort=9000
RemoteControlRole=Remote
RemoteControlBackupPath=C:\Backup\VirtualVista
RemoteControlBackupInterval=20
```

Ini file on Vista desk

The following entries in the Vista desk's **D950system.ini** file are required to configure the system for this operation mode :

```
; ***** Emulation / RemoteControl (VirtualVista) *****
EmulationEnabled=No
EmulationBayCount=6
EmulationControlbayPosition=3

RemoteControlEnabled= Yes <- needs to be set to „Yes“
RemoteControlHost=192.168.2.55 <- IP Address of the Compact Remote's network port
RemoteControlPort=9000
RemoteControlRole=Main
RemoteControlBackupPath=C:\Temp
RemoteControlBackupInterval=20
```

Note : There are certain functions which can only be operated from the Desk, or functions which don't run in parallel on the Compact Remote and the Desk at the same time. Such functions are listed in Chapter 4.

2.2 „With Desk + Core“

This operation mode describes how the Compact Remote is connected to a Vista desk and the core at the same time. In this mode the Compact Remote can work online with the desk and in the case of a desk failure, it can take-over control of the core.

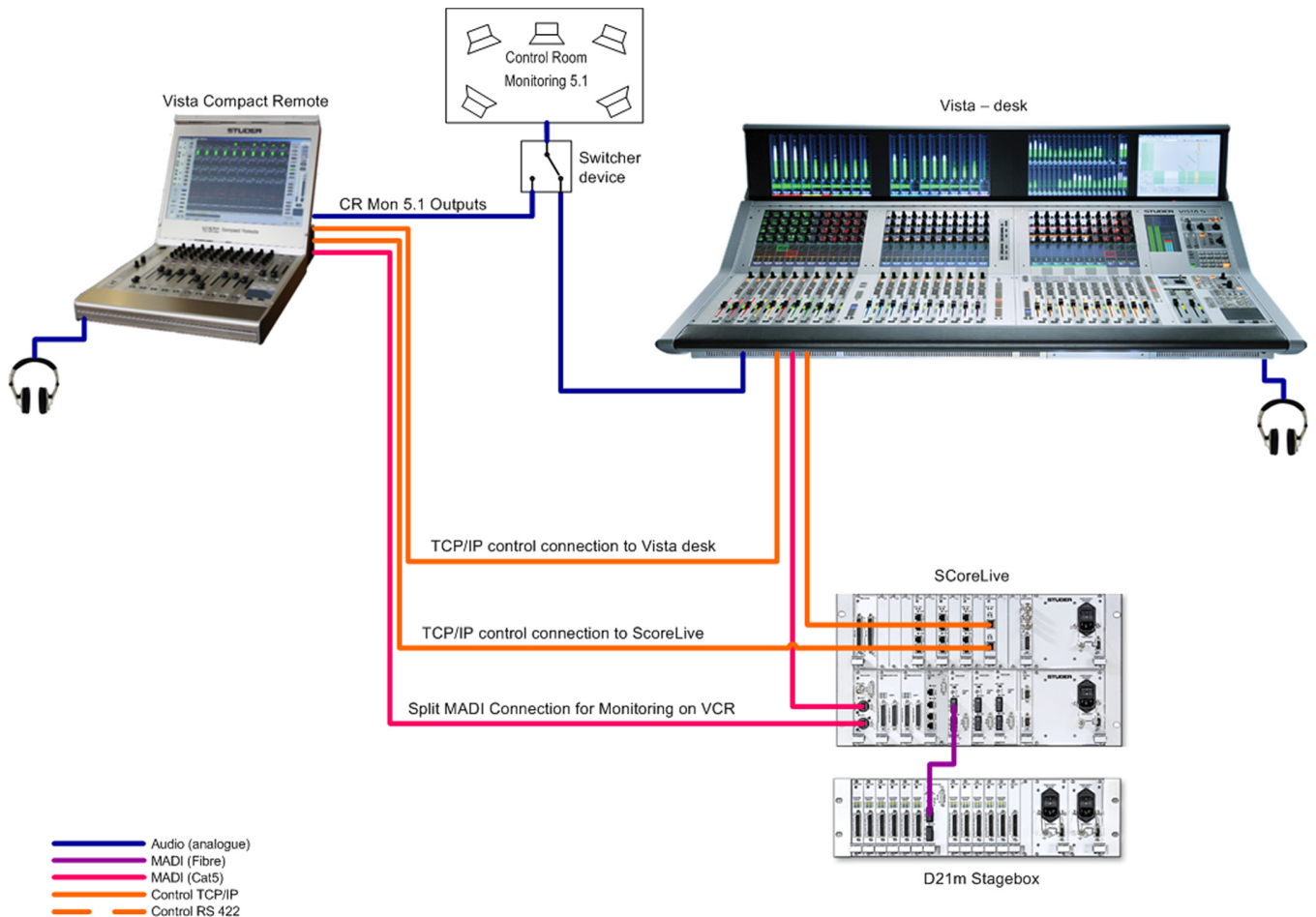

If desk redundancy needs to be achieved with the Compact Remote, it also needs to be connected to the DSP engine, in addition to its network connection to the Vista desk. This way it is capable to continue a mixing session in case of a desk failure.

The Compact Remote can only be online with one unit at a time - either online with the desk, or online with the DSP engine. This online status is displayed in the Virtual Vista application. In the event of a desk failure, the button «Connect to Core» can be pressed which allows the Compact Remote to communicate with the DSP engine directly.

Note : This «take-over» process takes a couple of seconds. Once control of the DSP engine is achieved, the online status displays this accordingly.

The online status display is an important tool to observe the state of the connection to the Vista system. In the normal online operation mode, the „Desk“ online status indicator is green; the „Core“ online status is grey. As long as the Vista desk is running properly, the desk is also controlling the dsp engine (Core). If the Vista desk has a problem and stops running properly, the user will be able to press “Connect to Core”, which forces the DSP engine to disconnect from the desk and start communication directly with the Compact Remote. In regard to the online status display this means that the online status indicator of „Desk“ must become grey – only then it is possible to press the „Connect to Core“ button and establish the control of the DSP engine by the Compact Remote.



Start-up

To get online with the Vista desk, the Virtual Vista on the Compact Remote should only be started when the Vista desk is already running and has completed its startup procedure, resulting in a green dot of the surveyor. If the ini files of both (Compact Remote and Vista desk) are configured properly, the online startup window appears on the screen of the Compact Remote.

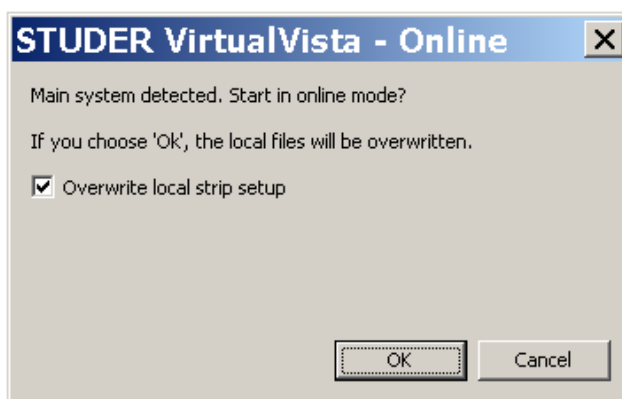

Clicking on either button now decides whether the Compact Remote goes online with the desk, or whether it starts offline. Going online with the Vista desk also implies, that all Vista desks production data gets copied over to the Compact Remote. All this data is stored in the Compact Remote's directory **C:\backup**.

Once the Compact Remote has fully started, the online status indicator shows that a „Desk“ is online.

In the case of a Vista desk failure, the green online status indicator would become grey – after this has happened, the button „Connect to Core“ can be pressed.

Configuration

This operation mode requires an additional network connection from the Compact Remote to the Bridge card of the SCoreLive. Here, if the control room monitoring should remain working in case of a main desk failure, also the MADI connection from system rack to the Compact Remote is necessary.

Ini file on Compact Remote

The following entries in the Compact Remote's **D950system.ini** file are required to configure the system for this operation mode:

[TcpIpAddr]

ScoreIp2=192.168.2.60 *<-here the ip address of the bridge card port needs to be configured*

Ini file on Vista desk

The following entries in the Vista desk's **D950system.ini** file are required to configure the system for this operation mode :

; ***** Emulation / RemoteControl (VirtualVista) *****

EmulationEnabled=No

EmulationBayCount=6

EmulationControlbayPosition=3

RemoteControlEnabled= Yes *<- needs to be set to „Yes“*

RemoteControlHost=192.168.2.55 *<- IP Address of the Compact Remotes network port*

RemoteControlPort=9000

RemoteControlRole=Main

RemoteControlBackupPath=C:\Temp

RemoteControlBackupInterval=20

Note : There are certain functions which can only be operated from the Desk, or functions which don't run in parallel on the Compact Remote and the Desk at the same time. Such functions are listed in Chapter 4.

2.3 „With Core“

This operation mode describes how the Compact Remote is connected directly to a Core, without a main desk being involved.

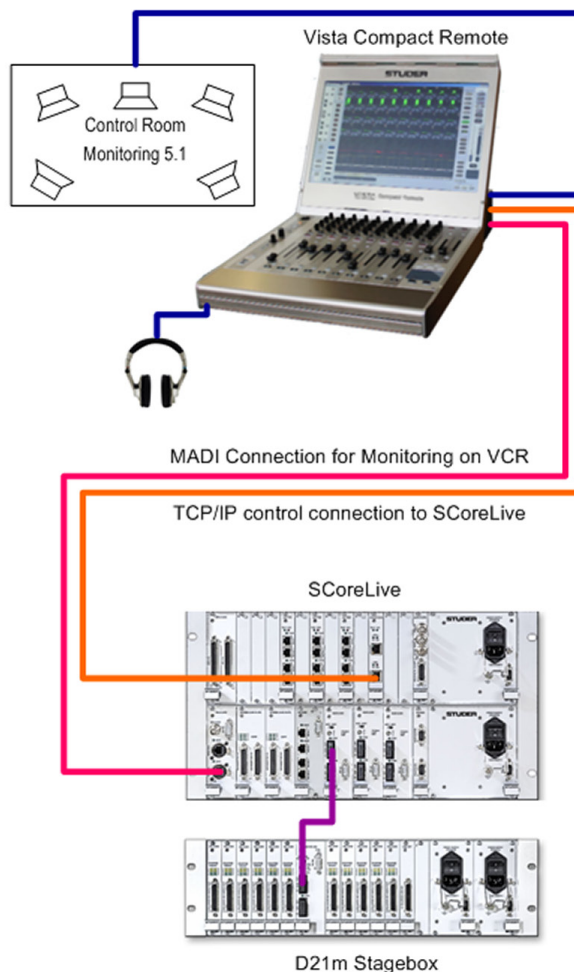

A Vista mixing system can be operated directly from the Compact Remote, without a Vista desk at all. This might be handy for certain productions where FOH space is limited to a minimum – or where the production only uses very few channels and it would not be worthwhile to carry the „real“ Vista desk around and possibly unpack it from its flight case.

In this mode, it is necessary to have the network connection to the dsp engine, and also the MADI signal from the D21m monitoring MADI card.

Since there is no Vista desk around, the Virtual Vista running on the Compact Remote will act as the Vista desk. In this mode it will start its own GC screen and will control all audio and monitoring parameters directly.

Start-up

When the Compact Remote is started up in this mode, the offline startup window appears on the screen of the Compact Remote.

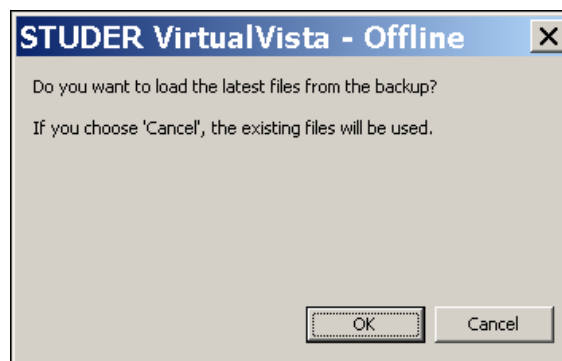

OK Loads the title which was backed-up the last time the Compact Remote was online with a desk.

CANCEL Loads the title which was used the last time the Compact Remote was running in offline mode.

Note: “Offline”, as indicated in the startup window actually always refers to the status of the Compact Remote in regard to the Vista Desk. Therefore the startup window also indicates the status “offline”, even though the Compact Remote is “online” with a dsp engine.

Once the Compact Remote has fully started, the online status indicator shows that a „Core“ is online.



Configuration

This operation mode requires a network connection from the Compact Remote to the Bridge card of the SCoreLive. Since the control room monitoring speakers will be fed by the Compact Remote, the Compact Remote’s MADI port has to be connected to the monitoring MADI-card of the system rack.

Ini file on Compact Remote

The following entries in the Compact Remote's **D950system.ini** file are required to configure the system for this operation mode :

; ***** General System Info *****

IsBridgeActive=Yes *<-needs to be set to "Yes"*

IsScoreUsed=Yes *<-needs to be set to "Yes"*

IsSpiderCoreUsed=No

IsD19Active=No

IsD21Active=Yes

; ***** Auto Save *****

AutoSaveTime=20 *<-here it is advisable to enter a value which is greater than 0, since there is no "real" Desk where the current settings are stored periodically. (e.g. a value of "20" lets the system update the startsnapshot every 20 seconds)*

[TcpIpAddr]

ScoreIp2=192.168.1.60 *<-here the ip address of the bridge card port needs to be configured - in the mode "with Core" it always has to be the primary port of the bridge card !*

2.4 „Offline“

In this operation mode, the Compact Remote is used as a standalone device.

Start-up

When the Compact Remote is started up in this mode, the offline startup window appears on the screen of the Compact Remote.

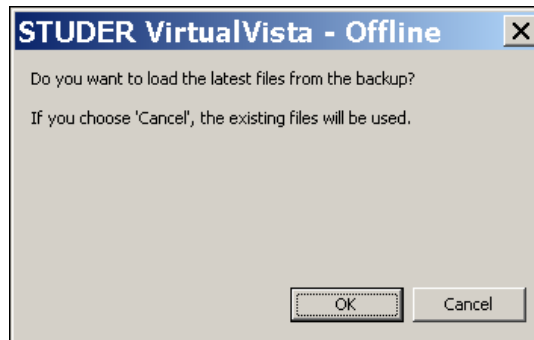

OK Loads the title which was backed-up the last time the Compact Remote was online with a desk.

CANCEL Loads the title which was used the last time the Compact Remote was running in offline mode.

Configuration

This mode can be used to prepare sessions without being connected to any part of the Vista mixing system. All the Compact Remote needs is mains power.

Preparing a Session

For this process, it is recommended that an existing production title has been copied from the Vista desk via the backup procedure. Such a backup can easily be „restored“ onto the Compact Remote via the restore procedure (File\ Restore Backup).

Make sure that after all the preparation work is done a new snapshot is made, and the title is saved with a new name. Then, a backup can be created (File\ Make Backup) and copied again onto a USB stick, in order to get the readily prepared title onto the „real“ Vista desk later on.

3 Operation

As the Compact Remote runs the Virtual Vista software – all mixing console parameters are operated on the Virtual Vista. The Compact Remote only adds hardware control elements to the Virtual Vista's GUI. Therefore, operation of the Compact Remote is based on operation of the Virtual Vista.

In this chapter, mostly operation instructions which don't apply to operating Virtual Vista on a normal computer or laptop (not on a Compact Remote) are listed :

3.1 Strip Setup

When the Compact Remote is online with a desk, it can have it's own strip setup, thus enabling the engineer working on the Compact Remote to arrange ,his/hers' channels independently from the channel layout of the desk. When starting online with a desk, normally the desks strip setup will be loaded to the Compact Remote as a starting point. But the Compact Remote's strip setup can then be changed and from then on be different from the desks strip setup.

Note : Every time the Virtual Vista application is started on the Compact Remote, the startup window appears.

Through this dialog, the user can decide whether the title from the backup folder should be loaded (the title that was open when online with a desk) , or the current local title of the Compact Remote (the title that was open the last time when being offline)

Depending on the situation, this opens in one of two different versions :

Offline

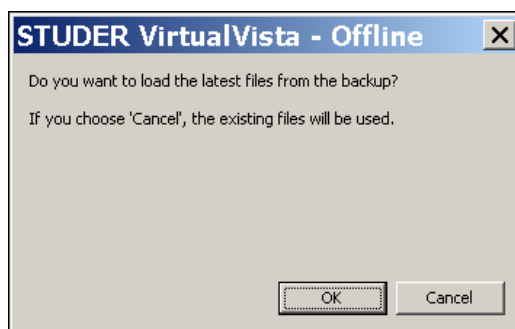

It can be chosen if the title from the backup folder should be loaded.

Online with desk

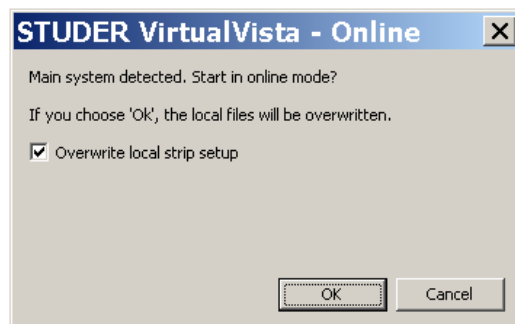

When online with a desk it can be chosen to „connect“ to this desk, or to stay offline. (**OK / CANCEL**)

When online with a desk, it can also be chosen whether the dek's strip setup should be loaded to the Compact Remote, overwriting the Compact Remote's local strip setup. If the Compact Remote's local strip setup should not be overwritten, the check-box „Overwrite local strip setup“ can be un-checked. In general, the strip setup on the Compact Remote appears in the size, as the Virtual Vista was configured during the setup process and stored in it's D950system.ini file.

This configuration can be changed at any time, and the Virtual Vista's desk size adapted to the currently required size. (A restart of the Virtual Vista is necessary after the ini file has been changed)

Grand Masters

The Compact Remote's Grand Master channel strips are located on the two fader strips on the right hand side of the Compact Remote. They stay always on the surface and can not be navigated away !

3.2 Navigation

To navigate between the different faderbays and controllbay of the Virtual Vista, the touch screen must be used. By selecting a bay, the Compact Remote maps the corresponding hardware controls (faders, rotaries and buttons) to this selected bay.

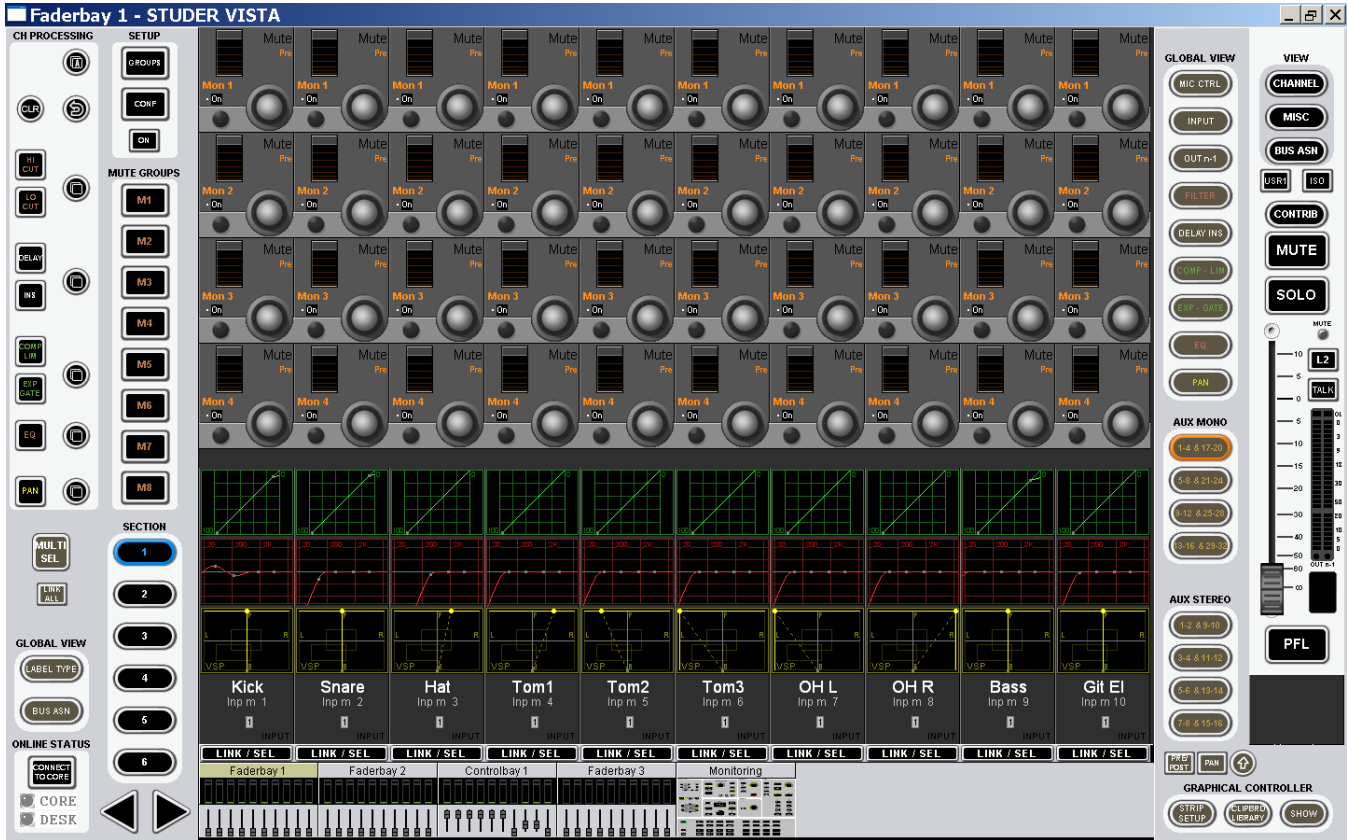

The above process is the first level of navigation -> to decide which of the Virtual Vista bays is mapped to the Compact Remotes surface.

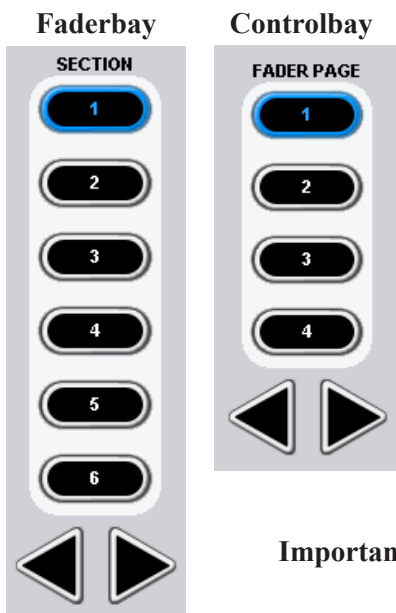

The second level of navigation is the scrolling and banking as it is known from any „real“ Vista desk. This is done with the six section buttons and the two arrows (for the faderbays), respectively with the four fader page buttons and the two arrows (for the controlbay). These section- and fader page buttons can be operated via the touch screen.

Important : In addition to the scrolling and banking, one needs to choose which bay is represented on the Compact Remote – this happens by touching into the desired bay of the Virtual Vista desk overview !

3.3 Copy and Paste



When copying channel parameters into the clipboard, the clipboard library window on the GC is automatically opened. This can have a disturbing effect – since the Compact Remote switches from the Virtual to GC view ! Therefore it is advised that after pressing a copy button, a few seconds should be waited until the GC view is shown, and then immediately the „**VIRTUAL**“ button on the Compact Remote can be pressed in order to get back to the „bay“ view, where the copied parameters can now be pasted into the desired channel(s).

3.4 Monitoring

The Compact Remote is able to „remote control“ a Vista desk’s monitoring facilities. Therefore Control Room and Studio monitoring of an online desk can be operated from the Compact Remote in parallel.

Redundant CR monitoring outputs The monitoring functionality has been implemented into the Compact Remote for failsafe reasons. Because a mixing session can be taken-over and finished with the Compact Remote in case of a failure of the Vista desk, it is also necessary to have a redundant source of the monitoring output signals. When a Vista 5 or Vista 9 desk has no mains power anymore, there will be no more audio signal on the monitoring outputs. But since these signals are still available from the DSP engine, they can be fed digitally to the Compact Remote.

Therefore the RJ45-MADI socket on the rear of the Compact Remote can be connected to the AUX port of the D21m monitoring MADI card and from there will be fed with split monitoring signals.

Split MADI Connection for Monitoring on VCR



During online operation with a desk, the analogue 5.1 CR outputs will provide identical signals as the 5.1 CR outputs of the desk. For emergency cases, the Compact Remote’s CR outputs can also be wired to monitoring loudspeakers, in order to make the Compact Remote a complete, small mixing console in case of a failure of the „main“ desk. It might be useful to connect the Compact Remote’s CR speaker outputs also to the control rooms main speakers via a small switcher device or patch cables.

PFL Included in the MADI signal from the D21m monitoring MADI card is also the PFL signal. So in order to get any PFL signal onto the Compact Remote’s headphone output, the Cat5 cable between Compact Remote and system rack must be in place !

Note : Also the PFL buttons on the Compact Remote „only“ remote-control the pfl buttons on the real desk. It is therefore clear that there is only one single PFL bus : Compact Remote and „main“ desk always hear the same PFL signal. (Vista 9 only : All desk fader strips can be assigned to the alternate PFL bus, and be separated from the Compact Remote’s PFL bus. But this is only possible with a Vista 9.)

Difference between Vista5 and Vista9 monitoring MADI signal

The order of monitoring signals in the MADI signal of a Vista 9 is as follows :

MADI Channel	1	2	3	4	5	6	7	8	9	10	11	12	13	14	15	16	17	18	19	20	21	22	23	24	25	26	27	28	29	30	31	32
Audio Signal	CR Main L	CR Main R	CR Main C	CR Main LFE	CR Main LS	CR Main RS	CR Main LB/BS	CR Main RB/BS	CR Nearfield L	CR Nearfield R	PFL L	PFL R	ALT PFL L	ALT PFL R	HEADPHONE L	HEADPHONE R	CR ALT L	CR ALT R	CR ALT C	CR ALT LFE	CR ALT LS	CR ALT RS	CR ALT LB/BS	CR ALT RB/BS	CR DIROUT L	CR DIROUT R	CR DIROUT C	CR DIROUT LFE	CR DIROUT LS	CR DIROUT RS	CR DIROUT LB/BS	CR DIROUT RB/BS

Where as the order of monitoring signals in the MADI signal of a Vista 5 is different :

MADI Channel	1	2	3	4	5	6	7	8	9	10	11	12	13	14	15	16	17	18	19	20	21	22	23	24	25	26	27	28	29	30	31	32
Audio Signal	PFL/Nearfield L	PFL/Nearfield R	CR Main L	CR Main R	CR Main C	CR Main LFE	CR Main LS	CR Main RS	CR DIROUT L	CR DIROUT R	CR DIROUT C	CR DIROUT LFE	CR DIROUT LS	CR DIROUT RS	INSERT DEC/ENC L	INSERT DEC/ENC R	INSERT DEC/ENC C	INSERT DEC/ENC LFE	INSERT DEC/ENC LS	INSERT DEC/ENC RS	STUDIO A L	STUDIO A R	STUDIO A DIROUT L	STUDIO A DIROUT R	STUDIO B L	STUDIO B R	STUDIO B DIROUT L	STUDIO B DIROUT R	HEADPHONE L	HEADPHONE R	GENERIC USE	GENERIC USE

This means that the Compact Remote must route these signals to the corresponding targets (headphone output, CR Mon outputs) depending whether it is online with a Vista 9 or a Vista 5.

Note : When the Compact Remote is offline, the routing of the monitoring MADI signals always remain as they were routed the last time the Compact Remote was online with a desk. If there is the need to change this manually (e.g. when a Compact Remote is used to work in the „with Core“ mode) the desk type that is required can be set in the **C:\D950system\Vista.ini** file :

LastKnownVistaRemoteVersion=5 <- set this value to 9 if your title on the Compact Remote comes from a Vista9

GUI

The monitoring page on the Virtual Vista (next to the right most bay in the overview window) gives access to all monitoring facilities of the desk that is online with the Compact Remote.

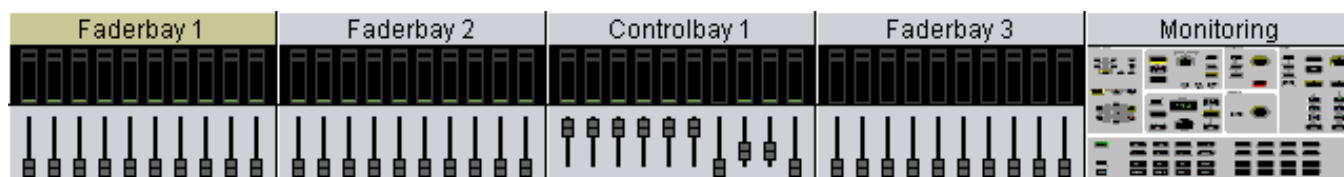

When the Compact Remote is offline, always the monitoring controls of the last connected desktype are shown. (Vista 5 or Vista 9, etc..) Here also all monitoring source buttons are shown, nicely labelled with source labels, just as they are programmed in the monitoring setup.

All monitoring and talkback controls can simply be operated by using the touch screen.

Please note that when the Downmix-setup button is pressed, the view must be changed to the GC, in order to see the downmix dialog window.

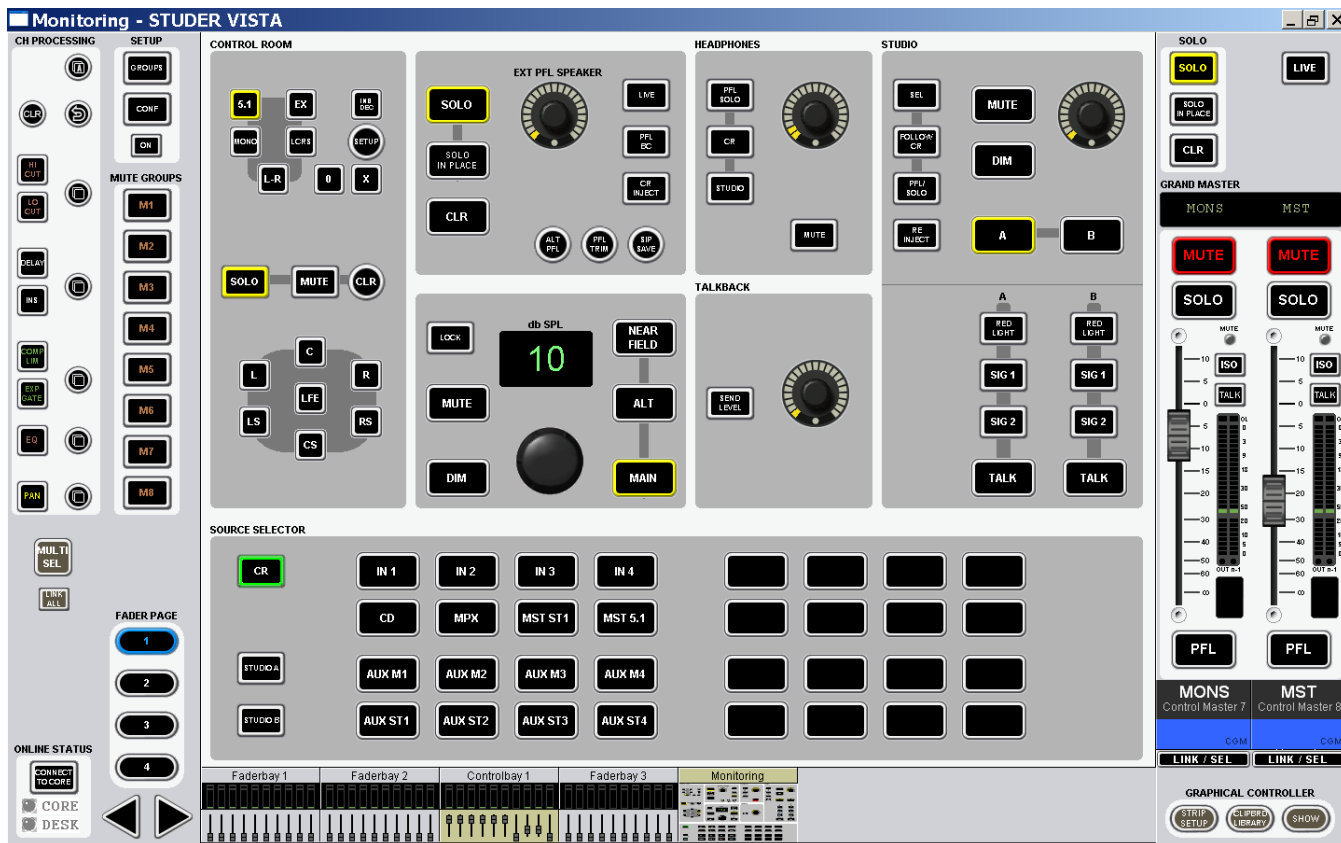

3.5 Tips and tricks

PFL via IEM

On rehearsals or when mixing in the auditorium in general, it might be useful to listen to the PFL bus on headphones. Instead of connecting the MADI cable from the system rack to the Compact Remote, a wireless InEar transmitter and receiver could be used to transport the PFL signal from the system rack to wherever the Compact Remote is in the auditorium. To achieve this, the PFL bus can be patched to any desired output port (e.g. to a D21m Line Output card), in addition to it being patched to its „normal“ target, the shared process PFL input. Don't forget to „lock“ this additional PFL patching – as it might get undone by recalling snapshots. The operator of the Compact Remote then would have the headphone plugged into the InEar receiver and would adjust the PFL volume level on the IEM device.

Power via UPS

In cases where the Compact Remote really needs to be mobile – e.g. when calibrating speaker levels in a theatre – the Compact Remote's mains voltage could be provided by a small UPS. This way, the Compact Remote as well as the UPS could sit on a wheeled flightcase and the operator would be able to freely move around the venue without any cabling required ! Since the power consumption of the Compact Remote is very little, already a small UPS could provide power for a long time (even with a very small ups such as the EATON 35 550 UPS, the Compact Remote runs for approx. 50 minutes).

4 Functional Differences between Compact Remote and Desk when online with Desk (with SW v5.0)

When a Virtual Vista (e.g. on a Compact Remote) runs online with a Desk, there are certain functions which can only be operated from the Desk.

There are also certain functions that don't run in parallel on the Virtual Vista and the Desk at the same time. Such functions are listed here in alphabetical order :

4.1 Blackout Event in CueList

When a Blackout Event is activated in a cue, only the Desk can perform this Blackout Event. In Online mode, the Virtual Vista is not able to perform a Blackout event.

4.2 Channel Settings Library

The copying and pasting of channel parameters is only possible on the Desk itself, or on the Compact Remote itself. It is not possible to copy parameters from the Desks channels and paste it into a channel of the Virtual Vista – or vice versa. Also parameters from the channel setting library can only be pasted to the desk and not to the Virtual Vista.

4.3 CGM/VCA Setup

The setup of Control Groups or VCA's is only possible on the Desk. Once the CGM/VCA's are defined, they can also be used from the Virtual Vista.

4.4 Conferencing

To setup Conference members from N-X channels is only possible from the Desk. Also activating and deactivating of the Conference can only be done on the Desk.

4.5 Dynamic Automation

Dynamic Automation of any parameters can only be operated on the Desk.

4.6 Faderglow™

Even though the physical faders of the Compact Remote don't feature Faderglow, the Faderglow colours are shown in the Virtual Vista fader view. Colour setup can be done in the Compact Remote's Strip Setup, which can differ from the Strip Setup of the Desk.

4.7 Vista FX

Vista FX parameters can currently (SW v5.0) not be operated on the Virtual Vista. This functionality will be implemented in a future SW release.

4.8 GEQ

On the Virtual Vista, GEQ parameter settings can only be viewn in the local Vistonics view – and not on the faders. Even though in the menu User\Vista

Settings\Misc the „GEQ Fader Placement“ view can be chosen – this is of no use for the Virtual Vista. Please also note that this „GEQ Fader Placement“-view setting can become different from the setting chosen on the Desk. This view setting is not synchronised between Virtual Vista and Desk.

4.9 Library Events

Currently (SW v5.0), the setup of Library Events in the CueList and the introduction of new Actors is only possible on a Vista Desk when offline !
Once all the Library Events are programmed, the CueList can be run also when the Virtual Vista is online with the Desk.

The functionality of setting up Library Events when the Desk is online with a Compact Remote will be implemented in a future SW release.

4.10 Mute Groups

The setup of Mute Groups is only possible on the Desk. Once the Mute Groups are defined, they can also be activated and deactivated from the Virtual Vista.

4.11 N-1 Assign dialog

The setup of input channels to N-X busses – which can be done through the N-1 Assign dialog – can only be done on the Desk.

Once the N-X bus owners are set-up, manual bus assigning can also be operated on from the Virtual Vista

4.12 Partial Snapshots

Partial Snapshots cannot be created from the Virtual Vista. „New Snapshots include : Gang“ therefore has no functionality.

Currently (SW v5.0), the existing Partial Snapshots can only be edited on the Desk , and not on the Virtual Vista.

In a future SW release, existing Partial Snapshots will also be editable on the Virtual Vista.

4.13 Relink

Only Mic Control management is possible when a Vista Desk ins online with a Virtual Vista.

4.14 Signaling

Redlight signaling as well as fader start is only possible on the Vista Desk.

4.15 Talkback

Currently (SW v5.0), Talkback is only possible from the Vista Desk, and not from the Virtual Vista – even if running on a Compact Remote.

This functionality will be implemented in a future SW release.

4.16 User Keys

User Keys on the channel strips (Usr 1, Usr 2) can only be used on the Vista Desk, and not on the Virtual Vista.

4.17 User\Vista Settings

Please note that all the settings in the menu „User\Vista Settings“ which are made when a Virtual Vista is online with a Desk, are not synchronised between Virtual Vista and Desk. Therefore these settings can differ between Virtual Vista and Desk.

Please ensure that these settings are not changed after the Virtual Vista has gone online with the Desk.

5 Specifications

CR Monitoring Line Outputs	Conditions / Details	Value
Impedance	(electronically balanced)	50 Ω
Output Level	$R_L \geq 600 \Omega$; + 15 dBu or + 24 dBu via internal jumpers	+15 dBu or + 24 dBu for 0 dB _{FS}

Ambient Conditions	Details	Value
Operating Temperature Range	see safety instructions	5 to 40 °C / 41 to 104 °F
Relative Humidity	see safety instructions	85%

Weight (approx.)		Value
Studer Vista Compact Remote		13.8 kg / 30.4 lbs

Power Supply	Conditions / Details	Value
Input Voltage Range	Power supply auto-ranging, with power factor correction (PFC); EN/UL approved	100 to 240 V AC \pm 10% 50 to 60 Hz
Consumption		50 W max.

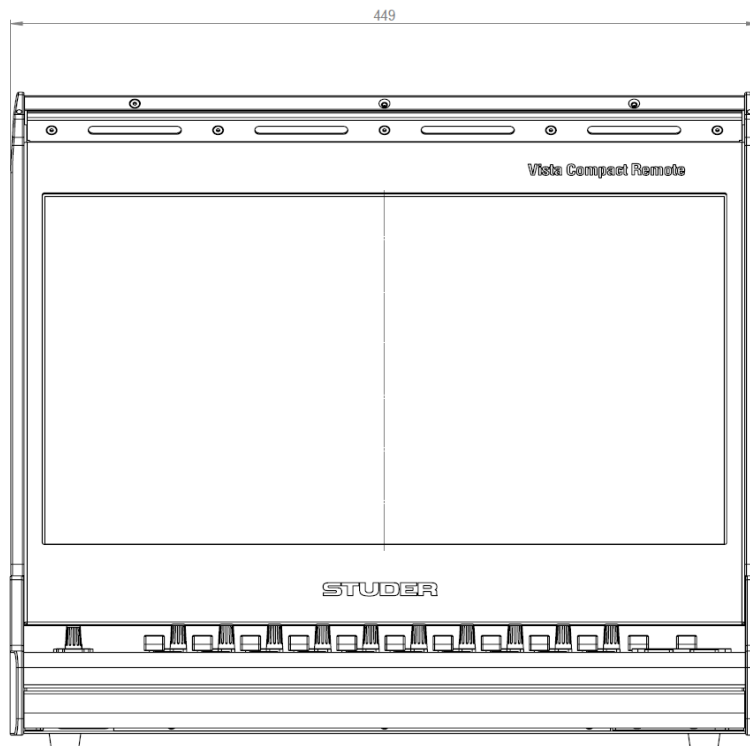
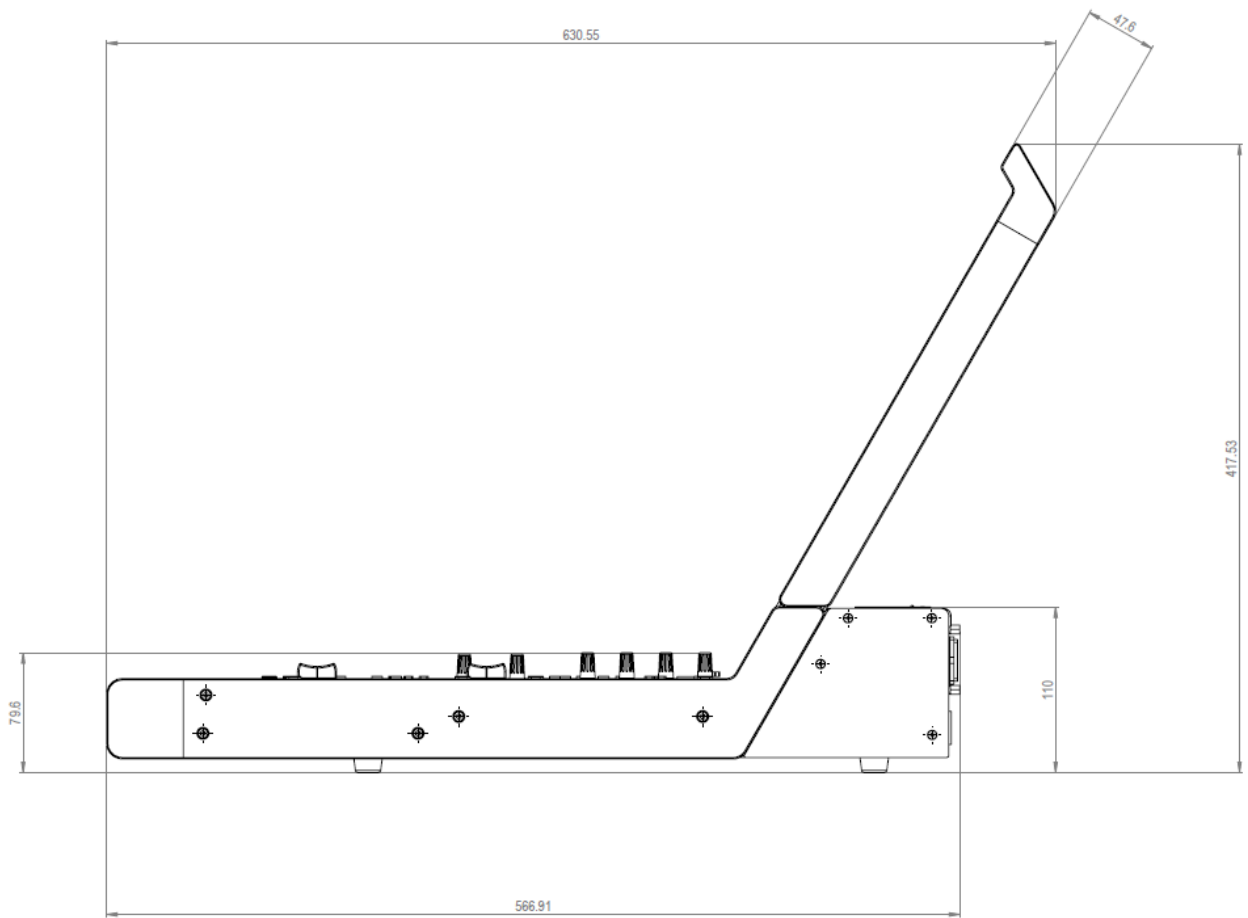

Disclaimer

The information in this document has been carefully checked and is believed to be accurate at the time of publication. However, no responsibility is taken by us for inaccuracies, errors, or omissions, nor is any liability assumed for any loss or damage resulting either directly or indirectly from use of the information contained within it.

Prepared and edited by
Studer Professional Audio GmbH
Technical Documentation
Riedthofstrasse 214
CH-8105 Regensdorf - Switzerland
<http://www.studer.ch>

Copyright by Studer Professional Audio GmbH

Order no. 5026124 (1013)

Subject to change