



CONTROL 25 ASSY

BRACKET

T-SP25

EX. 1 SHEET OF 1



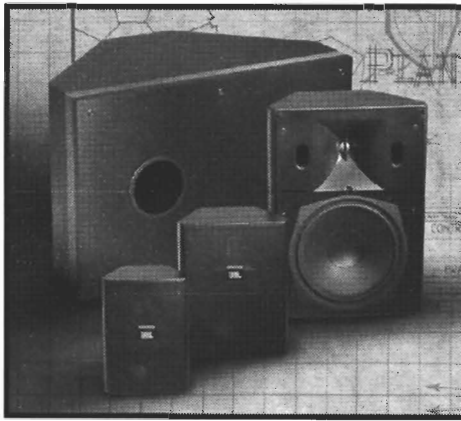

Welcome and Thank You .....	1
Product Description .....	2
The <i>InvisiBall</i> ™ Mounting System .....	3-4
Connections, Polarity, etc. ....	5-6
Sound Indoors .....	7-8
Sound Outdoors .....	9-10
Painting the Speakers .....	10
Specifications .....	11
Care & Maintenance, Troubleshooting .....	12
User Notes, Warranty .....	13

## F R A

Thank you for purchasing a pair of JBL Control® Series speakers. JBL sound systems are installed in some of the world's most famous arenas, stadiums, theme parks & clubs. In fact, JBL speakers keep the beat for today's hottest music acts, showcase stores and premier restaurants.

These speakers represent JBL Professional's Commercial Sound Solution™ to some of the most frequent requests of sound contractors worldwide. The Control® 23, Control® 25, Control® 28, & Control® SB-2 are specialized tools for skilled craftsmen.

For maximum product life and performance, read through this manual to familiarize yourself with the features, applications and cautions before you use your system.

If you need additional information:  
 -- Within the United States:  
 Contact your local JBL dealer or contact Applications Dept., JBL Professional, P.O. Box 2200 8500 Balboa Blvd, Northridge, CA 91329. In the USA, you may call Monday through Friday 8:am to 5:pm Pacific Coast Time (818) 894-8850.

-- In Other Areas Throughout the World: Contact your local JBL distributor or dealer.

Merci d'avoir fait l'acquisition de cette paire de haut-parleurs Control® Series de JBL. Les systèmes acoustiques JBL sont installés dans les lieux publics les plus prestigieux au monde, les stades, les parcs à thèmes et les clubs. En fait, les haut-parleurs JBL marquent le tempo dans les lieux musicaux les plus branchés d'aujourd'hui, dans les magasins réputés et les meilleurs restaurants.

Ces haut-parleurs offrent la Commercial Sound Solution™ (Solution acoustique commerciale) de JBL Professional et répondent à la plupart des demandes émanant des entreprises de sonorisation à travers le monde. Les Control® 23, Control® 25, Control® 28 et Control® SB-2 sont des outils spécialisés pour des artisans qualifiés.

Afin de maximiser la vie et les performances de ce produit, lisez attentivement tout ce manuel pour vous familiariser avec ses caractéristiques, son utilisation et les précautions à prendre avant d'utiliser ce système.

Si vous avez besoin d'informations complémentaires :  
 -- Aux Etats-Unis: Contactez votre revendeur local JBL ou écrivez à Applications Dept. JBL Professional, P.O. Box 2200, 8500 Balboa Blvd, Northridge, Ca 91329. Depuis les Etats-Unis, vous pouvez appeler du lundi au vendredi de 8 heures à 17 heures (heure du Pacifique) au 1-818-894-8850.

-- Partout à travers le reste du monde, contactez votre distributeur ou revendeur JBL.

## E S P

Gracias por comprar un par de altoparlantes JBL Serie Control®. Los sistemas de sonido JBL están instalados en algunos de los más famosos estadios, ruedos, parques de entretenimiento y salones del mundo. De hecho, los altavoces de JBL mantienen el ritmo para las presentaciones musicales más populares del momento, en las vitrinas y aparadores de las tiendas más modernas y en los mejores restaurantes.

Estos altavoces representan la Commercial Sound Solution™ (Solución de Sonido Comercial) de JBL Professional para algunos de los más frecuentes pedidos provenientes de contratistas de sonido a través del mundo. Los modelos Control® 23, Control® 25, Control® 28 y Control® SB-2 son herramientas especializadas para artesanos expertos.

Para asegurar un máximo de vida útil y productividad, lea este manual para familiarizarse con los rasgos, aplicaciones y advertencias antes de usar su sistema.

Si necesita información adicional:  
 -- En los Estados Unidos:  
 Comuníquese con su representante local de JBL o con el Depto. de Aplicaciones, JBL Professional, P.O. Box 2220, 8500 Balboa Blvd., Northridge, CA 91329. En los Estados Unidos, puede comunicarse por vía telefónica de lunes a viernes, 8:00 AM a 5:00 PM, hora de la Costa del Pacífico, al (818) 894-8850.

-- En Otras Areas del Mundo:  
 Comuníquese con su distribuidor o representante JBL local.

## D E U

Wir bedanken uns, daß Sie ein Lautsprecherpaar von JBL aus der Control® Serie gekauft haben. JBL Tonsysteme werden in vielen der berühmtesten Freilichttheatern, Stadien, Freizeitparks und Clubs verwendet. Auch Ladengeschäfte und Restaurants bringen Sie mit ihrem Sound zur Geltung.

Diese Lautsprecher sind als Commercial Sound Solution™ von JBL-Professional die Antwort auf die am häufigsten gestellten Anforderungen von Tonunternehmern weltweit. Bei Control® 23, Control® 25, Control® 28 und Control® SB-2 handelt es sich um Spezialgeräte für erfahrene Fachfirmen.

Für optimalen Einsatz und Lebensdauer des Systems lesen Sie bitte diese Anleitung durch, damit Sie mit den Besonderheiten, Anwendungsmöglichkeiten und Vorsichtsmaßnahmen vertraut werden, bevor Sie Ihr System benutzen.

Falls Sie noch weitere Informationen benötigen:  
 --Wenden Sie sich innerhalb der Vereinigten Staaten an Ihren örtlichen JBL-Händler oder setzen Sie sich mit dem Applications Dept., JBL Professional, P.O. Box 2200, 8500 Balboa Blvd., Northridge, CA 91329 (USA) in Verbindung. In den USA können Sie Montag bis Freitag von 8,00 bis 17,00 Uhr Westküstenzeit unter der Telefonnummer (818) 894-8850 anrufen.

--In anderen Teilen der Welt wenden Sie sich an Ihren örtlichen JBL Generalvertreter- oder Händler.

## 中文

谢谢您购买了一对 JBL 控制® 系列扬声器。世界上一些最著名的体育馆、运动场、旅游公园和俱乐部都装有 JBL 音响系统。事实上，目前最受欢迎的音乐表演、展览馆、商店和高档餐馆的音乐，都在采用 JBL 扬声器播放的。

这些扬声器是 JBL 公司为回应世界各地的音响工程承包商最常提出的一些需求而提供的专业商用音响解决办法。控制® 23、控制® 25、控制® 28 及控制® SB-2 是供熟练的音响专业人员使用的特殊工具。

为使产品获得最长使用寿命和最佳性能，请在使用之前仔细阅读本手册以便了解系统的特性、应用和注意事项。

如您另外还需要其它资料，请按下面的方法与我们联系：

--在美国国内，请与当地 JBL 销售商联系或与 JBL 公司联系，地址为：  
 Applications Dept.,  
 JBL Professional,  
 P.O. Box 2200, 8500 Balboa Blvd,  
 Northridge, CA 91329.  
 在美国，可于周一至周五太平洋岸时间早上八点到下午五点给本公司打电话，号码为：  
 (818) 894-8850。

在世界其它各地，请与当地 JBL 分销商或经销商联系。

# PRODUCT DESCRIPTION

FRA

ESP

DEU

中文

## Control® 23, Control® 25, Control® 28

These full range models of the Control® Series for contractors are designed for a wide variety of applications, be it outdoors, indoors, painted to match decor, stacked together, or arrayed side-by-side. Optional cluster mounting brackets and distribution transformers enhance commercial value to the series, and further demonstrate JBL Professional's support of sound contractors.

Shipped in pairs, each loudspeaker is a two-way horn loaded system in a trapezoidal cabinet. Each cabinet is constructed of unpainted high impact polystyrene (HIPS). Each is rated as an 8Ω nominal impedance. Each includes the InvisiBaffle™ mounting hardware and the hex wrench required to install it.

## Control® SB-2

The Control® SB-2, a slot loading vented bandpass subwoofer, has been specially tuned to compliment all full range Control® Series systems. The SB-2 features a unique concept in acoustic filtering by use of the Load Baffle™, a special geometric combination of rigid and pliable materials that acts in conjunction with a greatly simplified crossover network to achieve a steep sloped roll-off typically possible only with active crossovers. With a dual voice-coil transducer, the SB-2 has stereo 8Ω inputs with full bandwidth satellite outputs that employ spring terminals configured to accept dual banana plugs. Mass and structural integrity are balanced for a distortion-free low end in 15" x 23" x 11.5 black or white vinyl-wrapped wooden enclosures.

This subwoofer model of the Control® Series is designed to accept both channels of a stereo (L & R) amplifier output. The SB-2 will reproduce the low bass notes of the signal and pass a full bandwidth signal on to any speakers connected to the Satellite Output. The Control® SB-2 employs a single 10" woofer with dual 8Ω voice coils. The woofer radiates directly from the trapezoidal enclosure, but fires into a Load Baffle™ that stands-off from the woofer by an amount calculated to offer passive attenuation of all unwanted high frequencies. The system is tuned by means of a port, the tube of which extends from inside the enclosure all the way out to a vent in the Load Baffle.

This manual is intended to offer general guidelines to aid in installation and application of the products.

For detailed specifications and polar response data on the series, please refer to the individual spec sheets available from JBL Professional.

## Control® 23, Control® 25, Control® 28

Cette gamme complète de modèles des Séries Control® destinée aux entreprises est conçue pour un grand nombre d'applications, aussi bien intérieures qu'extérieures, peintes pour se fondre dans le décor, empilées ou encore en montage côte à côte.

Des consoles de montage et des transformateurs de distribution en option ajoutent encore à la valeur commerciale de ces séries et démontrent le soutien technique apporté par JBL aux entreprises de sonorisation. Livrés par paires, ces enceintes sont des modèles à deux voies, avec pavillon sous une forme trapézoïdale. Chaque enceinte est construite en polystyrène hautement résistant (HIPS) teinté dans la masse. Leur impédance nominale est de 8Ω. Chacune intègre le système InvisiBaffle™ et la clé à 8 pans nécessaire à son installation.

## Control® SB-2

Le haut-parleur d'extrêmes-graves avec charge bass-réflex à fente de charge Control® SB-2, a été spécialement étudié pour venir compléter tous les modèles de la gamme Control® Series. Le SB-2 offre un concept unique en filtrage acoustique en utilisant Load Baffle™, une combinaison géométrique spéciale de matériaux souples et rigides agissant en conjonction avec un filtre passif considérablement simplifié afin d'obtenir une pente raide typiquement possible avec des filtres actifs. Équipé d'un transducteur à bobine mobile double, le SB-2 possède des entrées stéréo 8Ω avec des sorties satellite à large bande utilisant un bornier compatible MOP. La masse et l'intégrité structurelle sont étudiées pour éviter la distorsion dans le grave, avec des enceintes en bois, recouvertes de vinyle noir ou blanc de 37,5 cm x 57,5 cm x 28,75 cm.

Ce modèle de haut-parleur d'extrêmes-graves Control® SB-2 est conçu pour accepter les deux canaux stéréophoniques (droit et gauche) de sortie d'un amplificateur. Le SB-2 reproduit les très basses fréquences du signal et laisse passer une bande passante complète dans n'importe quel haut-parleur connecté à la "Sortie satellite". Le Control® SB-2 utilise un haut-parleur de graves unique de 25 cm monté avec des bobines mobiles doubles de 8Ω. Le haut-parleur des graves rayonne directement depuis l'enceinte trapézoïdale, mais est dirigé vers un Load Baffle™, écarté du haut-parleur des graves d'une distance calculée afin d'obtenir une atténuation passive de toutes les hautes fréquences. Le système est accordé au moyen d'un évent dont le tube relie le Load Baffle™ au volume de charge.

Ce manuel a pour but de vous offrir les directives d'aide à l'installation et aux applications de ces produits.

Pour des spécifications plus détaillées et des données de réponses polaires sur les séries, veuillez vous reporter aux fiches de spécifications individuelles disponibles auprès de JBL Professional.

## Control® 23, Control® 25, Control® 28

Estos modelos de gama completa de la Serie Control® para contratistas están diseñados para una amplia gama de aplicaciones, ya sea al aire libre, bajo techo, pintados para complementar la decoración, apilados juntos o colocados uno al lado de otro.

Opciones tales como soportes para instalación agrupada y transformadores de distribución aumentan el valor comercial de la serie, y reafirman el apoyo de parte de JBL Professional a los contratistas de sonido. Empacados en pares, cada altavoz es un sistema de dos vías con trompeta en un gabinete trapezoidal. Cada gabinete es construido de poliestireno de alto impacto (HIPS), sin pintar. Cada uno tiene una impedancia nominal de 8Ω e incluye los adaptamientos de instalación InvisiBaffle™ y la llave hexagonal necesaria.

## Control® SB-2

El Control® SB-2, un sistema pasabanda ventilado de subgraves con carga de ranura, ha sido especialmente afinado para complementar todos los sistemas Serie Control® de frecuencia completa. El SB-2 presenta un concepto único de filtración acústica al utilizar el Load Baffle™ (panel de carga), una combinación geométrica especial de materiales rígidos y flexibles que actúa en conjunto con una red de cruce de frecuencias muy simplificada para lograr grandes pendientes de caída que típicamente solo se puede lograr con redes activas. Con su transductor de doble bobina, el SB-2 tiene entradas estéreo de 8Ω con salidas satélites de gama completa, las cuales utilizan terminales de resorte configuradas para aceptar clavijas tipo "banana" duales. Se han equilibrado la masa y la integridad estructural para brindar una respuesta a bajas frecuencias libre de distorsiones en un gabinete de madera de 15" x 23" x 11.5" (aprox. 380mm x 583mm x 291mm) recubierto con vinilo blanco o negro.

Este altavoz para bajas frecuencias de la Serie Control® está diseñado para aceptar los dos canales (L & R) de la salida de un amplificador estéreo. El SB-2 reproducirá las frecuencias bajas de la señal y pasará una señal de gama completa a cualquiera de los altavoces conectados a la "Salida Satélite". El Control® SB-2 utiliza un parlante de bajas frecuencias de 10" (aprox. 253mm) con bobinas dobles de 8Ω. El parlante de bajas frecuencias emite sonido directamente del gabinete trapezoidal, pero dispara hacia un Load Baffle™ separado del parlante por una distancia calculada para ofrecer pasiva atenuación (sistema de atenuación pasiva) de todas las frecuencias altas que se desean excluir. El sistema es afinado por medio de un puerto, el tubo que se extiende desde el interior del gabinete hasta un respiradero en el Load Baffle™.

El propósito de este manual es ofrecer una pautas generales para asistir en la instalación y aplicación de los productos.

Para especificaciones detalladas y para la información de respuesta polar de la serie, favor de referirse a las hojas de especificaciones individuales disponibles a través de JBL Professional.

## Control® 23, Control® 25, Control® 28

Diese Full-Range-Modelle der Control®-Serien für Tonunternehmer eignen sich für ein breites Anwendungsspektrum, sei es die Anwendung im Freien, in Innenräumen, farblich an das Dekor angepaßt, aufeinander gestapelt oder nebeneinander angeordnet. Wahlweise erhältliche Bündelmontagehalterung und Verteilertansformatoren erhöhen den Wert für den gewerblichen Einsatz und demonstrieren außerdem die Unterstützung von JBL Professional für Tonunternehmer.

Bei den in Paaren ausgelieferten Lautsprechern handelt es sich um einen Zweiweg-Hornlautsprecher in einem trapezförmigen Gehäuse. Jedes Gehäuse besteht aus ungelacktem, stoßsicherem Polystyrol. Jeder Lautsprecher ist mit einer Nominalimpedanz von 8Ω bewertet. Die InvisiBaffle™ Montageteile und der für die Montage notwendige Imbusschlüssel sind beige packt.

## Control® SB-2

Der Control® SB-2, ein ventilierter Bandpaß-Subwoofer mit Hornladung, wurde speziell darauf abgestimmt, alle Full-Range-Systeme der Control®-Serien zu ergänzen. Bietet der SB-2 ein einzigartiges Konzept akustischer Filterung durch die Benutzung des Load Baffle™, eine besondere geometrische Kombination von Starkkörper- und biegsamen Materialien, die in Verbindung mit weniger passiven Komponenten wirken, um eine normalerweise nur mit aktiven Frequenzweichen mögliche Dämpfung im Filter bei steilem Frequenzabfall zu erreichen. Mit einem Doppel-Schwingspulen-Transducer-Lautsprecher ausgestattet, hat das Modell SB-2 Stereo-Eingänge mit 8Ω Impedanz mit breitbandigen Satelliten-Ausgängen, bei denen Federkabelschuhe verwendet werden, die auf die Aufnahme von Doppel-Bananensteckern ausgelegt sind. Massen- und Strukturintegrität sind ausgewogen, um einen verzerrungsfreien Fußpunkt in schwarzen oder weißen mit Vinyl umhüllten Holzgehäusen mit den Ausmaßen 15" x 23" x 11.5" (ca. 38,10cm x 58,42cm x 29,21cm) zu erreichen.

Dieses Subwoofer-Modell der Control®-Serien ist so ausgelegt, daß es beide Kanäle eines Stereo-Verstärkers (links und rechts) aufnehmen kann. Der SB-2 reproduziert die tiefen Bässe eines Signals und gibt ein Signal mit voller Bandbreite an die Satelliten-Lautsprecher weiter. Der Control® SB-2 verwendet einen einzelnen 10"-Woofer mit 8Ω Doppel-Schwingspulen. Der Woofer strahlt direkt aus dem trapezförmigen Gehäuse aus, sendet jedoch in ein Load Baffle™, dessen Abstand vom Woofer so errechnet wird, daß eine passive attenuation aller unerwünschter Hochfrequenzen ermöglicht wird. Das System wird durch eine Anordnung abgestimmt, deren Röhre vom Inneren des Gehäuses zu einer Lüftungsoffnung im Load Baffle™ reicht.

Mit diesem Handbuch wird beabsichtigt, Ihnen allgemeine Richtlinien zu geben, die Ihnen bei der Montage und Anwendung der Produkte helfen sollen.

Falls Sie detaillierte Angaben und polare Ansprechdaten benötigen, sehen Sie bitte in dem von JBL Professional erhaltenen individuellen Datenblatt nach.

## 控制® 23、 控制® 25、 控制® 28

这些为工程承包商提供的全音域控制®系列型号是为各种各样的应用场合设计的,可用于室外或室内,可喷漆染色以与环境相一致,可叠放也可并排排列。另有组合安装支架和分配变压器选项,可增加该系列的商业价值。这进一步显示了JBL Professional对音响工程承包商的支持。扬声器成对装运,每个扬声器均为二路号筒式设计,装于梯形音箱中。音箱用未上漆的高强度聚苯乙烯(HIPS)制成。每个音箱均包括隐形球™安装硬件及安装所需六角扳手。

## 控制® SB-2

控制® SB-2为一个槽装敞开式带通超低音扬声器。经过专门设计可配套所有控制®系列全音域音箱。控制® SB-2采用负载隔音板,因其具有独特的声学滤波特性。负载隔音板为一刚性和柔性材料组合的特殊几何组合,它可以大大简化了分频网络设计,却可获得通常只有电子分频器才能得到的陡峭分频曲线。控制® SB-2具有双音圈的喇叭单元,输入为8欧姆立体声。输出端采用弹簧接口,亦可接受双香蕉插头。利用重量与结构上的协调,最低频失降至最低。音箱为木质结构,外面包有黑色或白色乙烯基塑料膜面,尺寸为:15英寸X23英寸X11.5英寸。

这一控制®系列的超低音型号设计用来接受立体声放大器输出的双声道(左声道和右声道)。SB-2将重现信号的低音音符,并将全带宽信号传送到连接在"卫星输出"上的扬声器上。控制® SB-2采用单个具有双8欧姆音圈的10英寸低音扬声器。该低音扬声器直接从梯形音箱中发声,但经负载隔音板。负载隔音板和低音扬声器之间的协调经过计算,以便将所有不必要的高频波动衰减掉。系统的调谐通过一个端口来进行,其管径从音箱内部一直延伸到负载隔音板的一个出口上。

本手册旨在为本产品的安装和应用提供总的指南。

如需了解详细规格及该系列的极性响应资料,请参阅产品的规格表。产品的规格表可向JBL Professional公司索取。

1

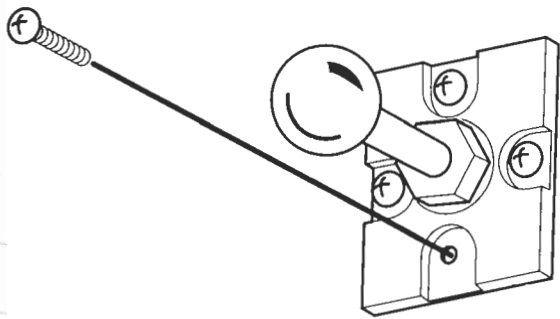

• MOUNT TO WALL

2

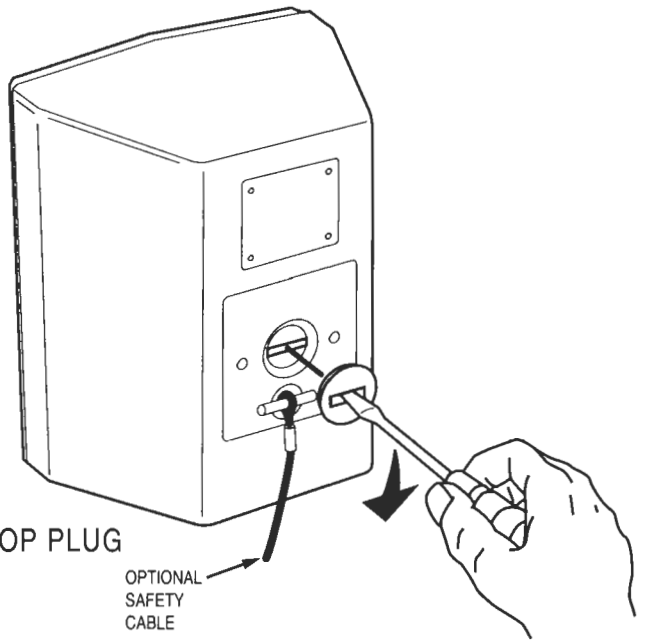

• POP PLUG

OPTIONAL SAFETY CABLE

3

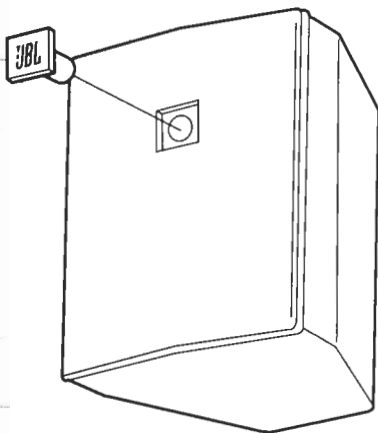

• REMOVE LOGO BADGE

4

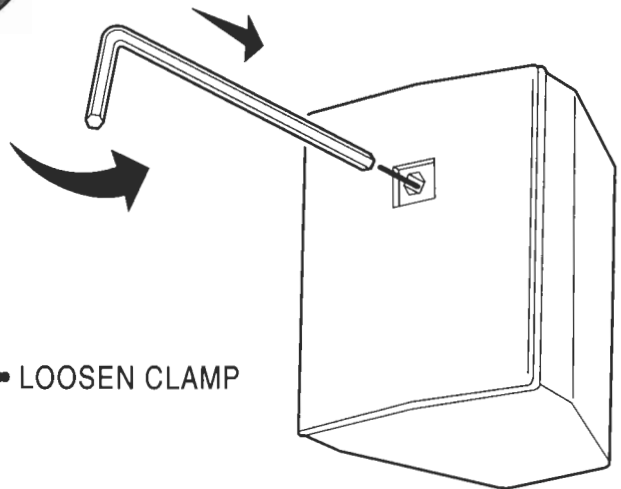

• LOOSEN CLAMP

5

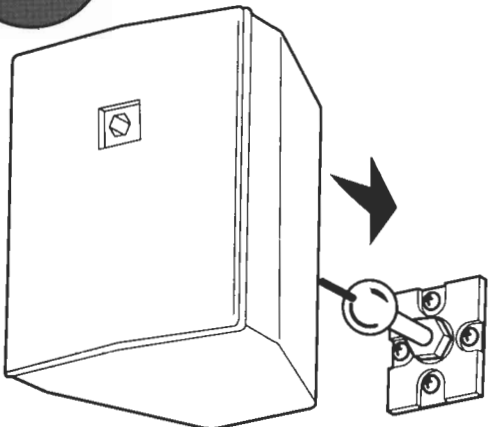

• ATTACH SAFETY CORD/MOUNT SPKR

6

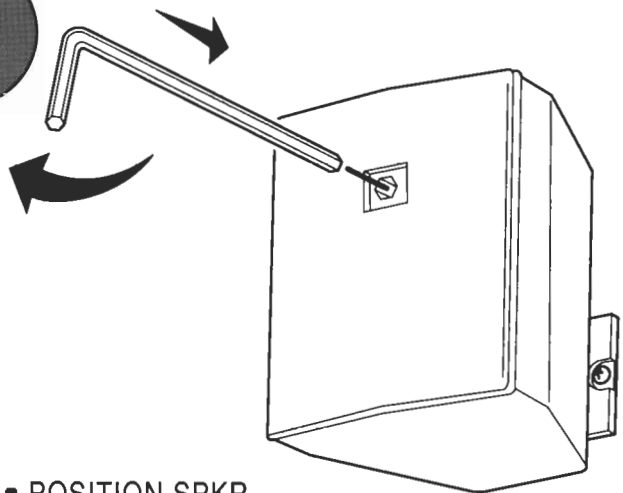

• POSITION SPKR, TIGHTEN CLAMP. REPLACE LOGO BADGE

# INSTALLATION

## Installing with the InvisiBall™ Mounting System -

The *InvisiBall™* is a unique method of mounting a loudspeaker. Patents are pending worldwide on this design. The *InvisiBall™* is designed to be unobtrusive, offer theft deterrence, and simplify the installers job.

**NOTE:** Your installation of this Commercial Sound Solution must be done in conformity with local building codes. Please consult with a licensed contractor or professional engineer on any installation in which the loudspeakers are mounted on a ceiling or wall. JBL Professional is not responsible for damages resulting from the negligent installation of any bracket or speaker.

1. Install the *InvisiBall™* mount on the wall using the screws as shown in Fig. 1. Again, be very certain that the type of anchor is appropriate for the wall material, and that the wall material will support the speaker.
2. Stick a wide tipped, slotted screwdriver in the slot of the plastic *InvisiBall™* knock-out plug and push downward, thereby breaking the plug out of the back of the speaker as shown in Fig. 2. Be sure the ball will fit in the hole by scraping away any residual plastic around the hole.
3. Grab the logo badge on the speaker grill with your fingernails and pull it straight out as shown in Fig. 3.
4. Insert the supplied hex key into the hole exposed by the logo badge. Lightly push and slowly rotate the hex key until you feel the key fall into place. Loosen the *InvisiBall™* clamp as shown in Fig. 4.
5. Mount the speaker on the *InvisiBall™* as shown in Fig. 5.
6. Tighten the clamp just enough to hold the speaker while you position it in the desired orientation as shown in Fig. 6. When the speaker is pointing just the way you want it, tighten it firmly and replace the logo badge. **CAUTION: DO NOT OVERTIGHTEN.**

## FRA

La méthode de montage d'un haut-parleur avec *InvisiBall™* est unique en son genre. Les brevets sont en instance pour le monde entier à propos de ce produit. L'*InvisiBall™* est conçu pour être discret, permet d'éviter les vols et simplifie la tâche des installateurs.

**REMARQUE:** L'installation de cette Commercial Sound Solution™ (Solution acoustique commerciale) doit être réalisée selon les règles locales sur la construction. Prenez contact avec un entrepreneur ou un ingénieur composant le mur et que ce matériau est en mesure de supporter le haut-parleur. JBL Professionnal n'est pas Responsable des dommages éventuels dus a un montage Défectueux de consoles ou de haut-parleurs.

1. Vissez le montage *InvisiBall™* au mur selon le dessin de la figure 1. Encore une fois, assurez-vous que le type d'ancrage correspond au matériau composant le mur et que ce matériau est en mesure de supporter le haut-parleur.
2. Enfoncez un tournevis à large embout pour écrous à fente dans l'ouverture d'obturation en plastique *InvisiBall™* et poussez vers le bas, cassant ainsi l'opercule à l'arrière du haut-parleur selon le dessin de la figure 2. Assurez-vous que la bille correspond au trou en éliminant les restes de plastique sur son pourtour.
3. A l'aide de vos ongles, tirez sur le logo de la grille du haut-parleur et sortez-le de son emplacement selon le dessin de la figure 3.
4. Insérez la clé à huit pans fournie dans l'ouverture du logo. Poussez doucement et faites tourner la clé et assurez-vous de son bon positionnement. Desserrez la pince *InvisiBall™* selon le dessin de la figure 4.
5. Montez le haut-parleur sur l'*InvisiBall™* selon le dessin de la figure 5.
6. Serrez la pince suffisamment pour maintenir le haut-parleur pendant que vous le positionnez dans la direction désirée selon le dessin de la figure 6. Quand le haut-parleur regarde dans la direction voulue, serrez-la fermement et remettez le logo en place. **ATTENTION: NE PAS TROP SERRER.**

## ESP

El *InvisiBall™* es un método único para colocar un altavoz. Está pendiente la concesión de patentes de este diseño en todo el mundo. El *InvisiBall™* está diseñado para ser discreto, ofrecer protección contra robo y simplificar el trabajo del instalador.

**NOTA:** La instalación de esta Solución Comercial de Sonido™ debe de hacerse en conformidad con los reglamentos de construcción locales. Consulte con un contratista autorizado o ingeniero profesional sobre cualquier instalación en la cual los altavoces sean colocados en el techo o en una pared. JBL Professional no se responsabiliza por daños que surjan como resultado de la instalación negligente de cualquier soporte o altavoz.

1. Atomille el soporte *InvisiBall™* a la pared tal como se representa en la Fig. 1. Nuevamente le recordamos que se asegure que el tipo de soporte ancla sea apropiado para el material del que consiste la pared, y que el material de la pared sea capaz de soportar el peso del altavoz.
2. Introduzca un destornillador de punta ancha ranurada en la ranura del destapadero plástico del *InvisiBall™* y empuje hacia abajo para romper el destapadero hacia la parte trasera del altavoz, tal como se representa en la Fig. 2. Asegúrese que la bola entre en el agujero, removiendo cualquier residuo plástico que quede en el borde de este.
3. Agarre la insignia del logotipo en la parrilla del altavoz con las uñas y tire directamente hacia afuera como se representa en la Fig. 3.
4. Inserte la llave hexagonal dentro del agujero expuesto al remover la insignia del logotipo. Empuje suavemente y gire la llave hexagonal lentamente hasta que sienta que la llave caiga en su sitio. Afloje la abrazadera del *InvisiBall™* tal como se representa en la Fig. 4.
5. Instale el altavoz en el *InvisiBall™* tal como se representa en la Fig. 5.
6. Apriete la abrazadera solo lo suficiente para sostener el altavoz mientras lo posiciona en la orientación deseada tal como se representa en la Fig. 6. Cuando el altavoz esté posicionado tal como Usted lo quiere, ajuste la abrazadera firmemente y vuelva a colocar la insignia del logotipo en la parrilla. **PRECAUCION: NO APRETAR DEMASIADO.**

## DEU

Bei *InvisiBall™* handelt es sich um eine einzigartige Methode der Lautsprechermontage; die Patentanmeldungen hierfür sind weltweit erfolgt. *InvisiBall™* wurde unter dem Aspekt konstruiert, unauffällig zu sein, vom Diebstahl abzuhalten und die Arbeit des Monteurs zu erleichtern.

**ANMERKUNG:** Die Montage dieser Commercial Sound Solution™ muß gemäß den örtlichen Bauvorschriften durchgeführt werden. Bitte lassen Sie sich bei allen Montagen, bei denen Lautsprecher an einer Decke oder einer Wand montiert werden, von einem zugelassenen Bauunternehmer oder einem Ingenieur beraten. JBL haftet nicht für Schäden, die aus der fahrlässig durchgeführten Montage einer Halterung oder eines Lautsprechers herrühren.

1. Schrauben Sie die *InvisiBall™* Halterung wie in Abb. 1 gezeigt an der Wand an. Wir machen nochmals darauf aufmerksam, daß Sie sich vergewissern müssen, daß die verwendeten Schrauben bzw. Dübel für das Wandmaterial geeignet sind und daß das Wandmaterial den Lautsprecher tragen kann.
2. Führen Sie einen Schraubendreher mit breiter Spitze in den Schlitz der aus Kunststoff bestehenden *InvisiBall™* Buchse und drücken Sie nach unten, wobei Sie dadurch die Abdeckung aus der Rückwand des Lautsprechers, wie in Abb. 2 gezeigt, herausbrechen. Vergewissern Sie sich, daß die Kugel in das Loch paßt, indem Sie den restlichen Kunststoff rund um das Loch wegkratzen.
3. Ergreifen Sie mit den Fingernägeln die Logomarkie auf dem Lautsprechergitter und ziehen Sie diese, wie in Abb. 3 gezeigt, gerade heraus.
4. Führen Sie den beiliegenden Inbusschlüssel in das durch die Entfernung der Logomarkie sichtbar gewordene Loch. Drücken Sie den Inbusschlüssel leicht an und drehen Sie diesen, bis Sie fühlen, daß der Schlüssel greift. Lockern Sie die *InvisiBall™*-Klemmschraube wie in Abb. 4 gezeigt.
5. Montieren Sie den Lautsprecher am *InvisiBall™*, wie in Abb. 5 gezeigt.
6. Ziehen Sie die Klemmschraube so fest an, daß der Lautsprecher gehalten wird, während Sie diesen, wie in Abb. 6 gezeigt, wie gewünscht ausrichten. Wenn sich der Lautsprecher genau in der von Ihnen gewünschten Position befindet, ziehen Sie die Klemmschraube fest an und bringen Sie die Logomarkie wieder an. **VORSICHT: NICHT ZU FEST ANZIEHEN.**

## 中文

隐形球™安装系统的安装程序

隐形球™是一个独特的安装扬声器的方法。该设计在世界各地的专利申请正在进行中。隐形球™不突出、易安装，且具有一定的防盗作用。

注意：安装商业音响解决办法系统必须符合当地建筑法规，将扬声器安装在天花板上或墙壁上时，请向持有执照的建筑承包商或专业工程师咨询。JBL Professional 公司对任何不经心地安装的支架和扬声器所造成的损坏不负任何责任。

1. 将隐形球™安装架按图一所示用螺丝拧在墙上。此处再一次请注意，一定要确定锚钉的类型对墙壁材料来说是合适的，且墙壁材料一定要能支持扬声器。
2. 将一宽头槽口式螺丝刀插入塑料隐形球™顶出螺栓的槽口中并向下推，从而将螺栓顶出扬声器的背面，如图二所示。注意使球能放入洞中，若放不进去，请将洞口周围残余的塑料刮去。
3. 用指甲拍住扬声器栅网上的徽章，按图三所示将其拔出。
4. 将随产品提供的内六角扳手插入徽章拔去后露出的孔中。轻推并缓慢转动，直到感觉扳手到位为止。按图四所示，松开隐形球™的夹钳。
5. 按图五所示，将扬声器安装在隐形球™上。
6. 将夹钳紧固至刚好可支持扬声器，然后将扬声器调至所需的方向。当您对讲扬声器的指向满意时，再将夹钳充分紧固，并将徽章装回原位。注意：螺丝不要拧得太紧。

# CONNECTIONS

**Input** - Simply connect the amplifier's "+" and "-" outputs directly to the red (+) and black (-) input jacks on the back of the enclosure (see diag. 1).

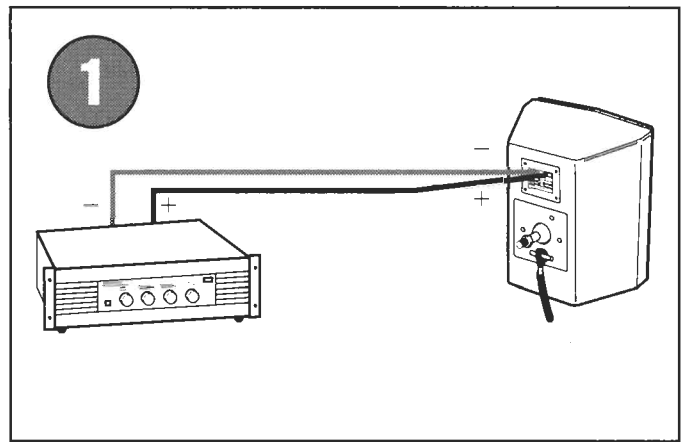

**8Ω each** - Since the loudspeakers have a rated impedance of 8Ω each, more than one speaker may usually be wired to one amplifier channel (see diag. 2). (See "amplifier impedance load" below.)

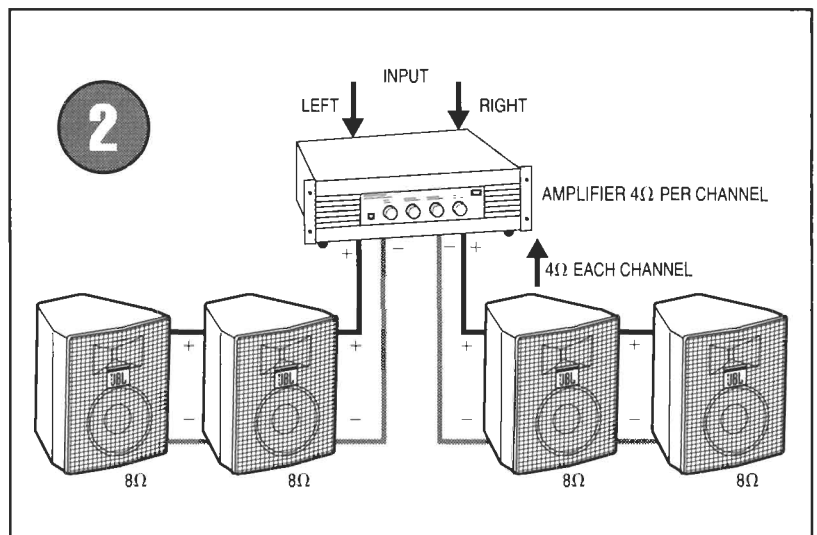

**Integrating the Subwoofer SB-2** - Treat each input of the Subwoofer as an 8Ω loudspeaker and wire into a complete system accordingly (see diag. 3). (See "amplifier impedance load" below.)

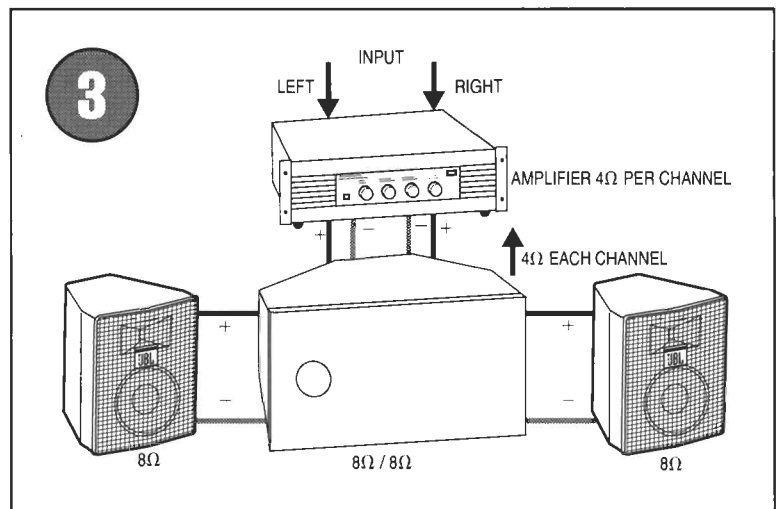

**Amplifier Impedance Load** - When you connect more than one loudspeaker system to an amplifier channel, either by twisting two wires together at the speaker location or via individual "home runs" from the speakers to the amplifier, the load impedance to the amplifier drops. To find the maximum number of 8Ω speakers that can be wired in parallel to each channel of your power amplifier, divide 8 by the amplifier's minimum impedance load recommendation (e.g. 8Ω Control® speaker ÷ 4Ω amp's minimum impedance = 2 speakers per channel, see diags. 2 & 3).

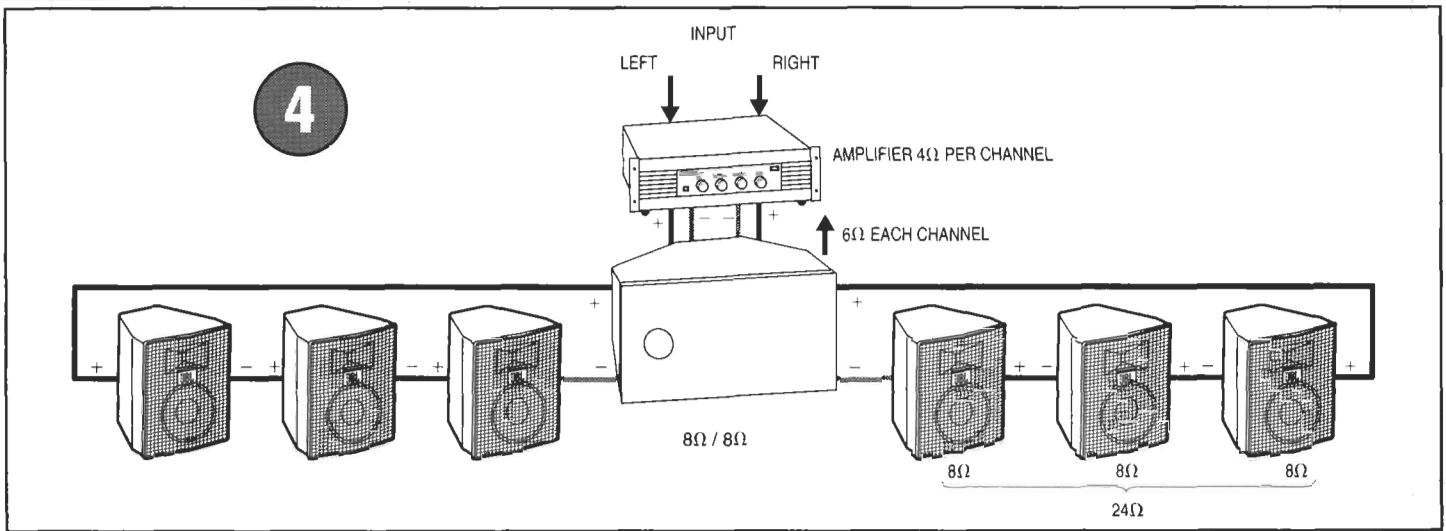

**Series/Parallel** - It is possible to utilize various series/parallel 'hook-up' topologies to increase the number of loudspeakers driven on an amplifier. See diag. 4 for one example of a series/parallel hook-up topology.

*Note: Mis-matching the speaker impedance such that it is below the minimum impedance rating of an amplifier channel can damage the amplifier and degrade performance. If the application requires more than 2 speakers per amplifier channel wired in parallel, a distributed line system should be considered. Also check your amplifier's manual for cautions and recommendations.*

**Importance of Correct Polarity ("In-Phase/Out-of-Phase")** - When two loudspeakers are wired with opposite polarity ("out-of-phase") relative to each other, the low frequencies of the loudspeakers cancel each other, even though the speakers are "working hard." Trying to correct the lack of bass with an equalizer can damage your loudspeakers -- equalization cannot correct polarity errors. Always make sure multiple speakers are connected in proper polarity. (See "Poor Low Frequency Output" in the Troubleshooting section for instructions about how to detect and correct polarity problems.)

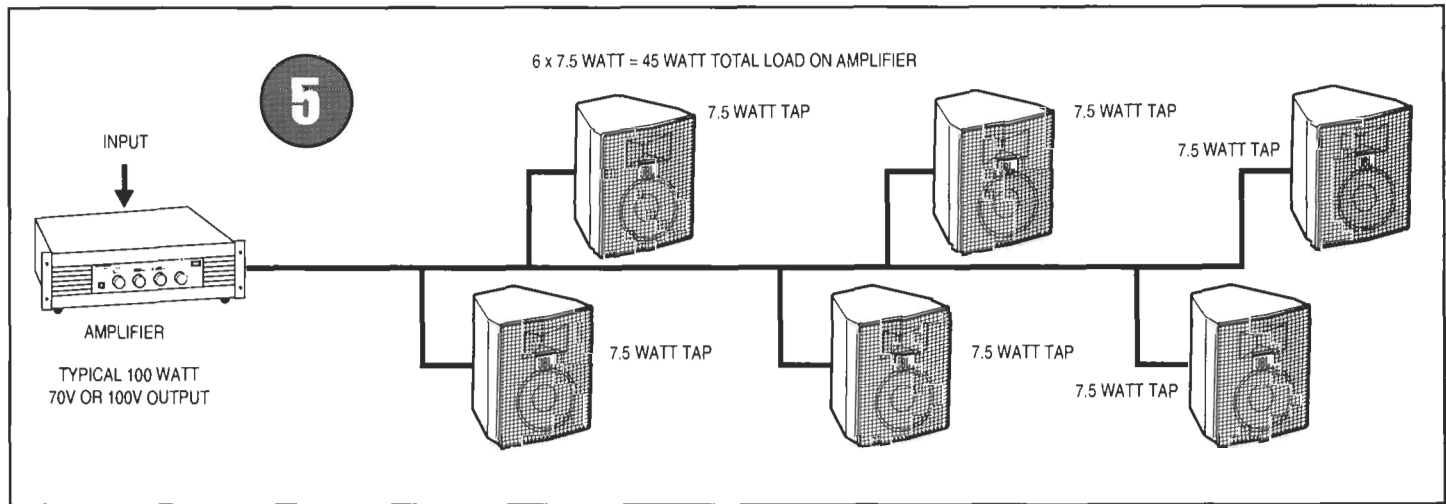

**Distributed Line Systems (Control "AT" models)** - The Control® 25AT & Control® 28AT models come equipped with built-in 70/100 volt autoformers. **These types of speakers need a line distribution amplifier.** As with conventional 8Ω speakers, simply connect the amplifier's "+" and "-" outputs directly to the red (+) and black (-) input jacks on the back of the enclosure. Set the autoformer tap to your desired wattage. Unlike conventional 8Ω speakers, you may connect as many "AT" speakers as you'd like to one amplifier channel *providing that all the speaker taps do not add up to more than the amplifiers power rating* (see diag. 5).

(e.g. A 100 watt amplifier channel could safely drive 13 speakers set to 7.5 watts each, i.e.  $13 \times 7.5 = 97.5 < 100$ ) A conservative rule-of-thumb is to try to keep the sum of the speaker loads (watts) under 3/4 of the power amp rating (e.g. A 100 watt amplifier channel will then drive 10 speaker set to 7.5 watts each, i.e.  $10 \times 7.5 = 75$  watts).

*Note: For more detailed information on line distributed systems, see JBL Professional's Technical Notes Vol. 1 No. 2A; "JBL Loudspeakers for Distributed Systems".*

• **Incident/Reflected/Absorbed** - JBL Control® Contractor series speakers are designed as fixed installation loudspeaker systems for use in a variety of environments. Performance may nevertheless vary from room to room because of differences in the acoustical setting. Since an enclosed room presents acoustical boundaries (walls, floors & ceilings), sound indoors exhibits quite complex behavior. Each time a sound wave strikes a boundary, part of the wave's energy is reflected and part is absorbed (see diag. 1). Reflection & absorption are dependent on the frequency of the sound wave and the angle at which it strikes the boundary.

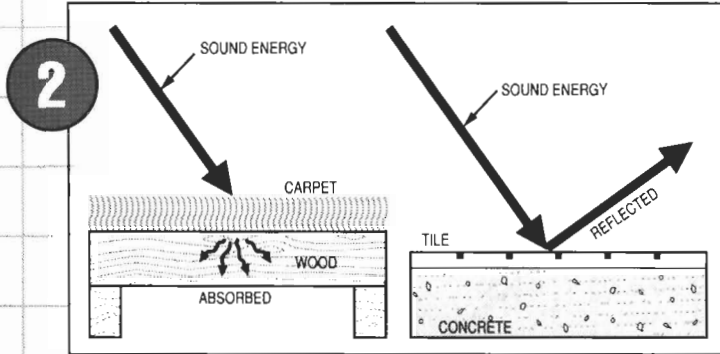
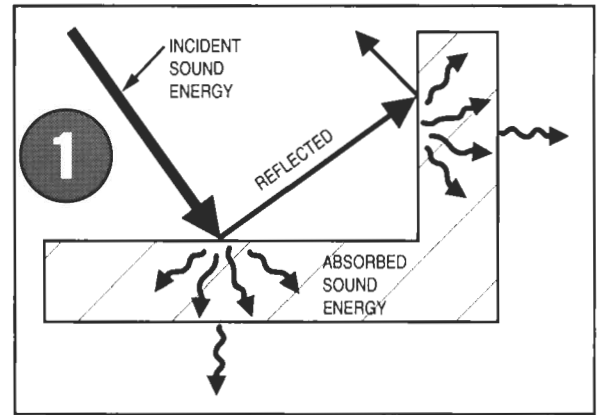

• **Absorption** - When designing your system, note that people and furniture absorb sound, while glass and tile reflect sound. The percentage of energy that a boundary absorbs is often expressed by an *absorption coefficient* of the boundary material, where an absorption coefficient of 1=complete absorption and 0=perfect reflective surface (see diag. 2).

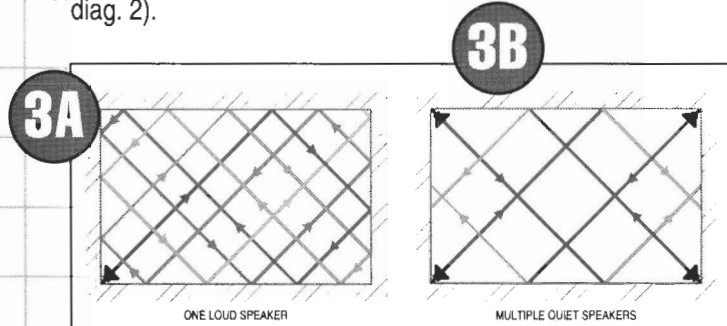

• **Reverberation** - *Reverberation* is the reflected sound waves continuing to bounce between the boundaries, losing energy with each reflection. When sound strikes the reflective boundaries of a room, after a time the room is filled with random reflected sound waves. Music and speech become unintelligible (see diag. 3A). To minimize reverberation in a highly reverberant room, it is advisable to install *more* speakers, and play them at lower levels (see diag. 3B).

# SOUND INDOORS

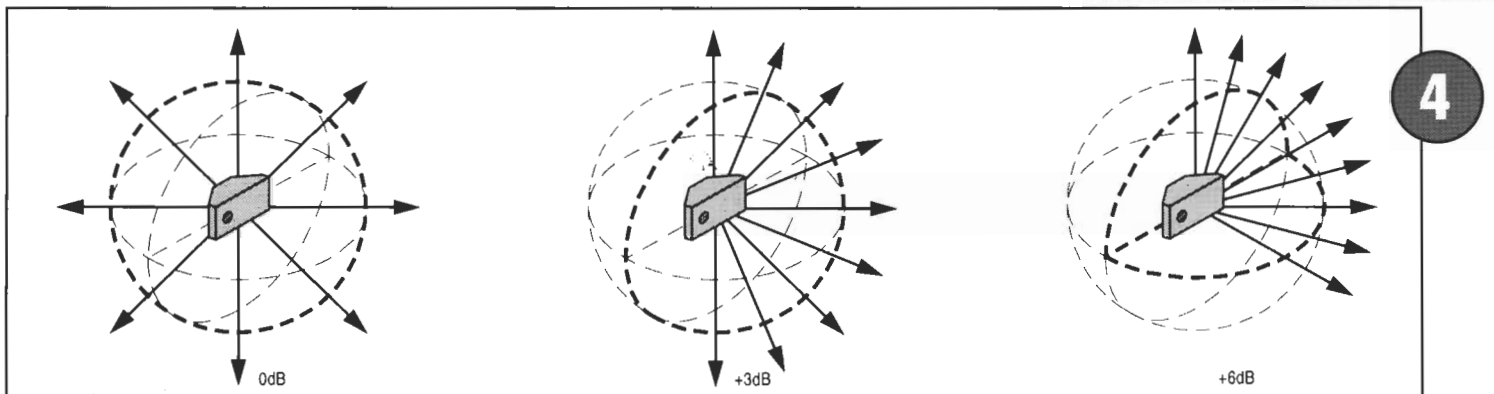
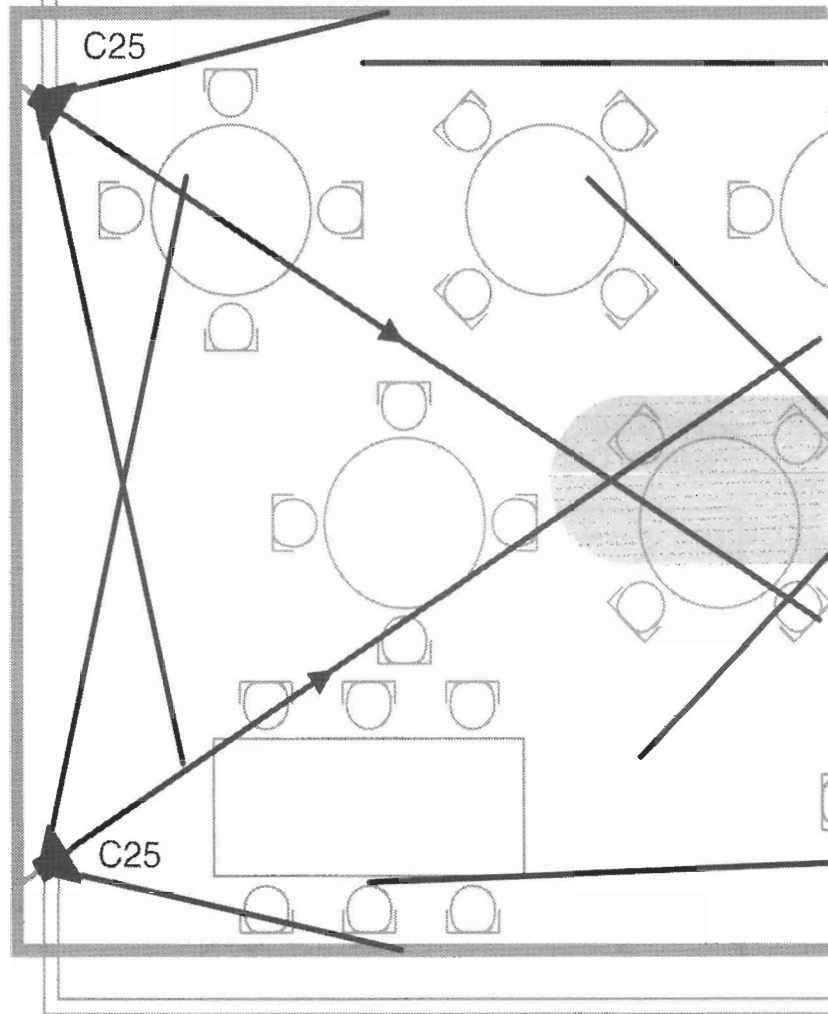



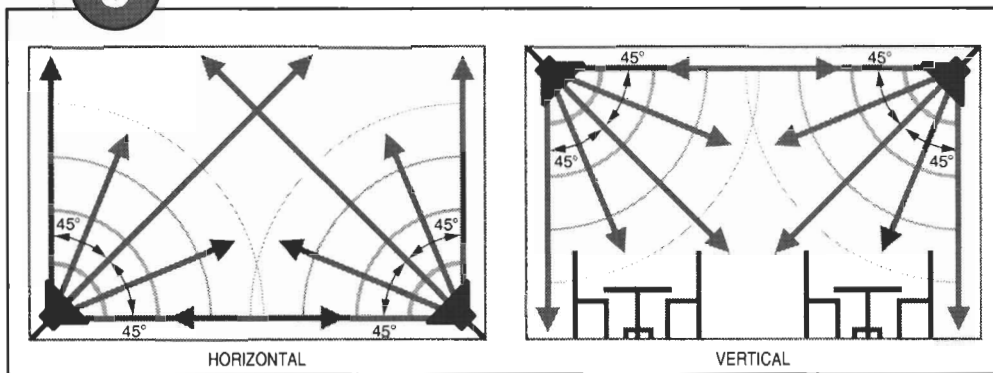

• **High Frequency Coverage** - High frequencies go where you point them. Simply aim the center axis of the speaker into the plane slightly above the listening area. The 90° x 90° horns of the Control® Contractor Series disperse the high notes by 45° off axis in every direction. For large or unusually shaped rooms, divide the area into zones and let the horn patterns dictate the spacing between the speakers (see diag. 5).

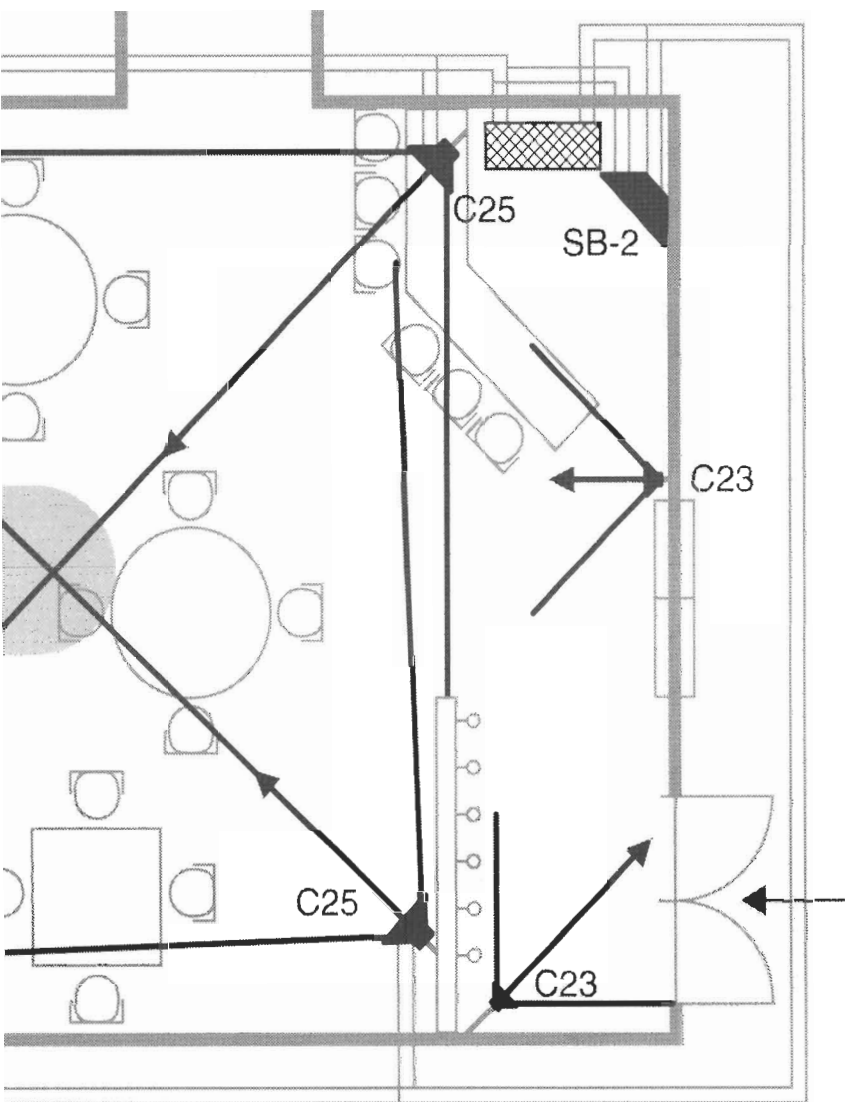

• **Boundary Loading** - This is a good trick for increasing bass without taxing the amplifier. It is also possible to make a system sound too "muddy", so use caution. If you move the speaker from open space to a wall, bass notes will increase by + 3dB. If you move it to a 2 boundary corner, another +3dB...and another +3dB for a three boundary corner! (see diag. 4).

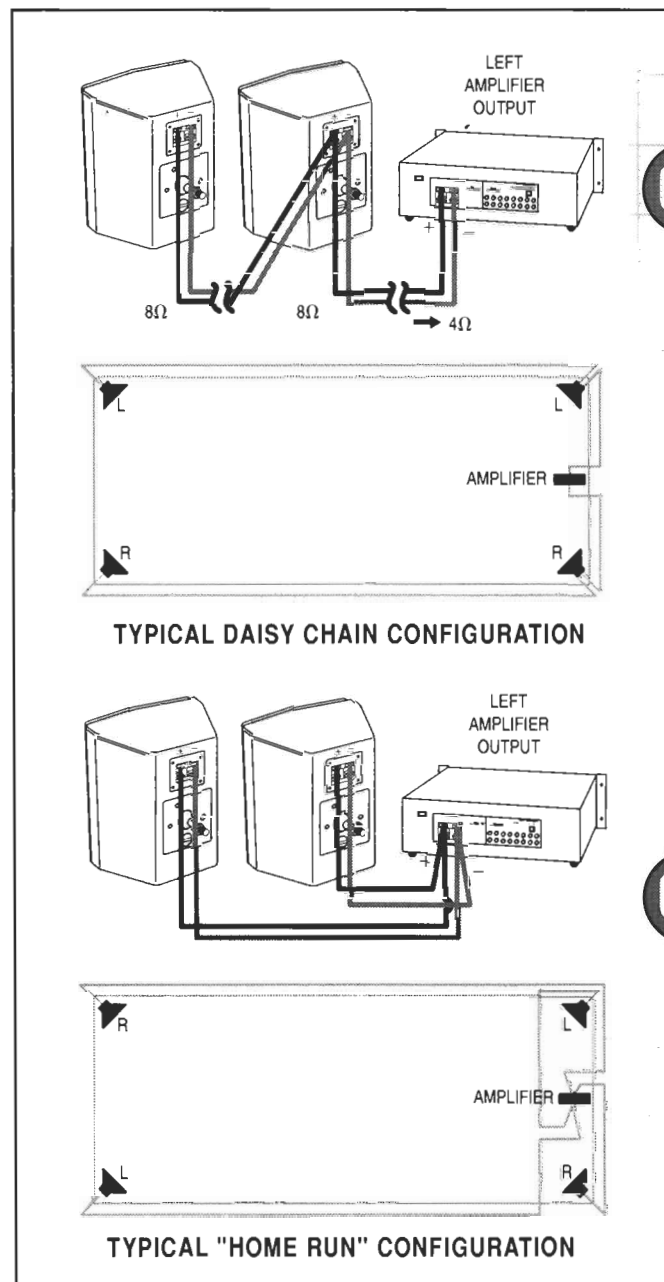

6A

6B

• **Daisy Chaining** - It is most common, easiest, and cheapest to run wires from the amp to a speaker, then from that speaker to another (see diag. 6A).  
 • **Home Runs** - If you desire true stereo L & R from each listening position, "home runs" are best, from the amplifier directly to each speaker (see diag. 6B).

# SOUND OUTDOORS

From the speakers to our ears - Since you usually want a target background SPL of about 70dB - 80dB to your listeners, keep in mind the Inverse Square Law, which states that in a free field with no walls, floor, or ceiling, the intensity of sound decreases with the square of the distance. For example when you double the distance between the speaker and your listener's ear, the SPL decreases by 6dB (i.e. If a speaker's output is 100dB SPL at 10 feet away, at 20 feet away the SPL is decreased to 94dB.) Don't forget, a 10dB drop will sound "half as loud".

- Wind - Wind gives the illusion that a sound is coming from a different direction than it really is. This creates a *resultant propagation vector* (see diag. 1). When sound propagates with the wind it tends to refract downward, and against the wind refract upwards (see diag. 2), (\*refraction is the term used to describe the bending of sound).

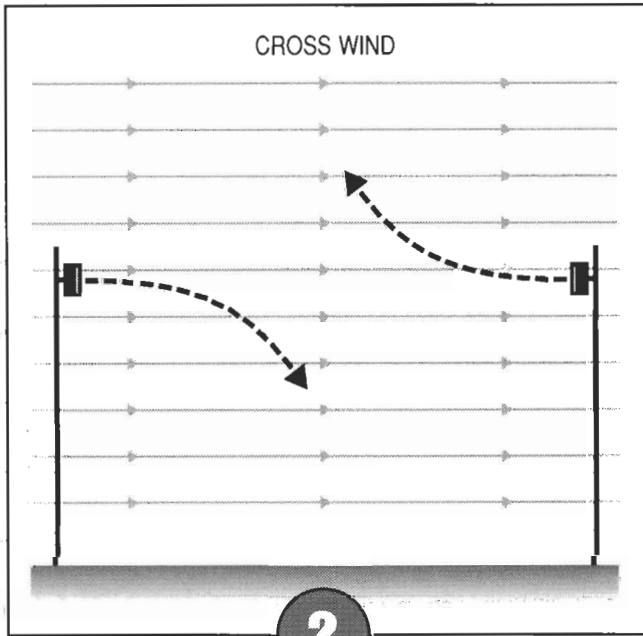
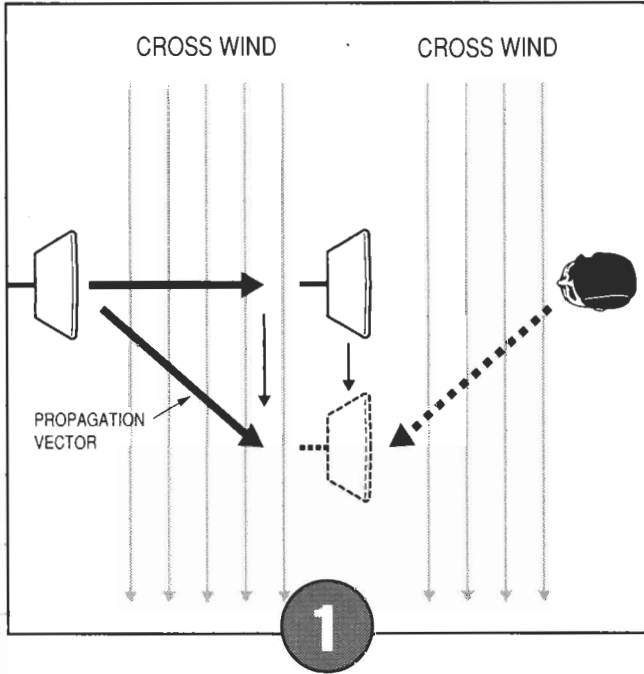

- Temperature - Temperature differences also have a small effect on sound propagation. Hot air is less dense than cold. Sound travels faster in a less dense medium and therefore speeds up as air gets warmer, and slows down as air gets cooler. The result is the refraction of sound. For example this may manifest itself as sound propagates over a cool body of water on a hot day. The sound will tend to "bounce" along the surface of the lake and travel a lot further than the *Inverse Square Law* may dictate (see diags. 3 & 4).

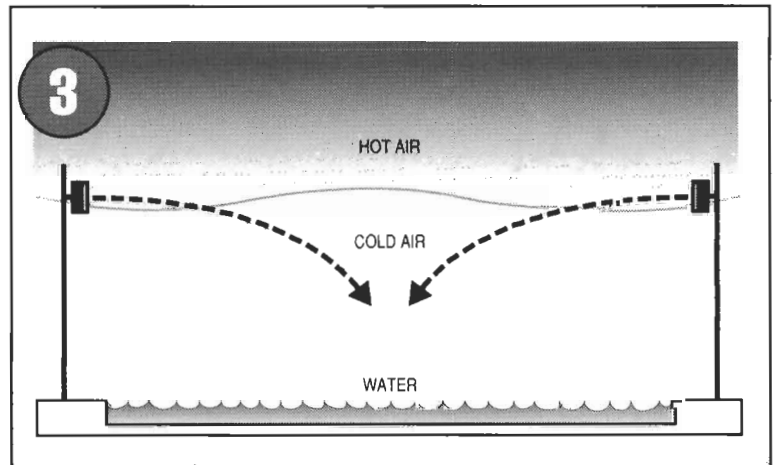
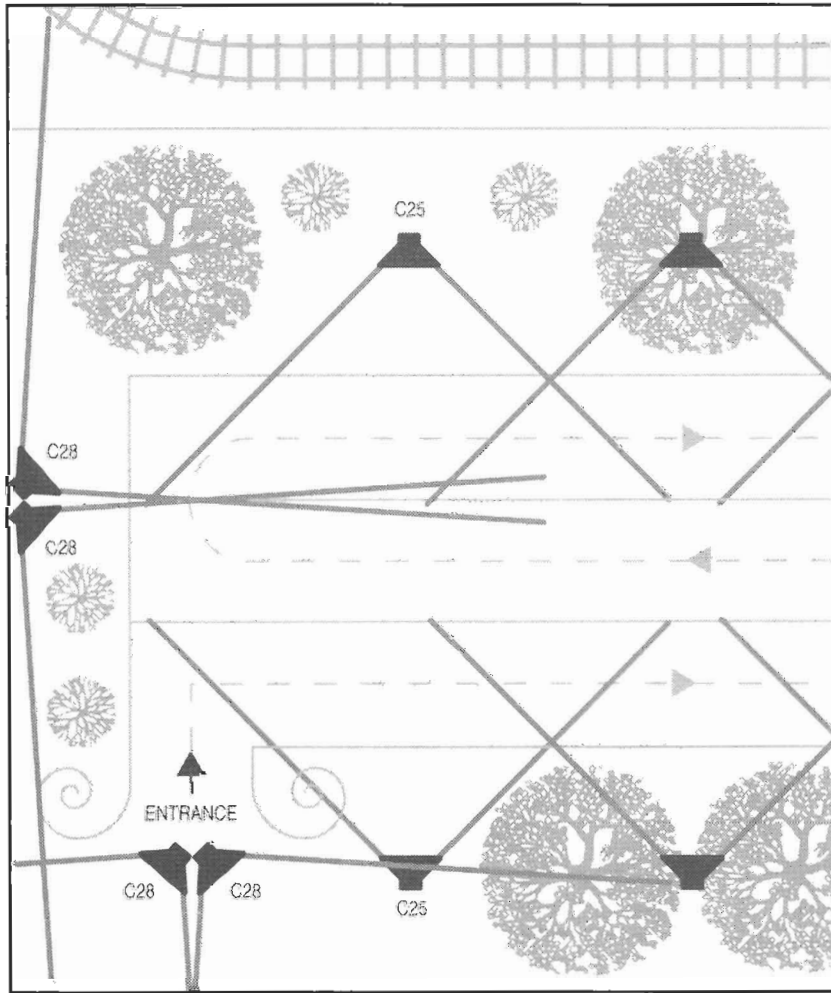

It is important to understand that just as the propagation of sound outdoors is effected by its surroundings so is the propagation of sound indoors. Some of these environmental factors exist in both cases, such as reflective surfaces and absorbant materials, but there are a few unique effects that may need to be considered. The factors described on this page can cause the behavior of an outdoor installation to deviate from the *Inverse Square Law*. Remember not all frequencies of the propagated sound will be affected uniformly.

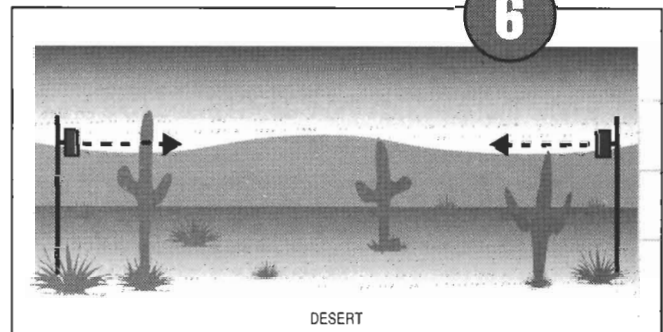
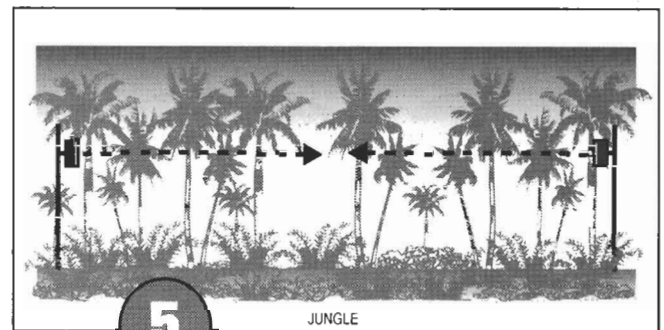
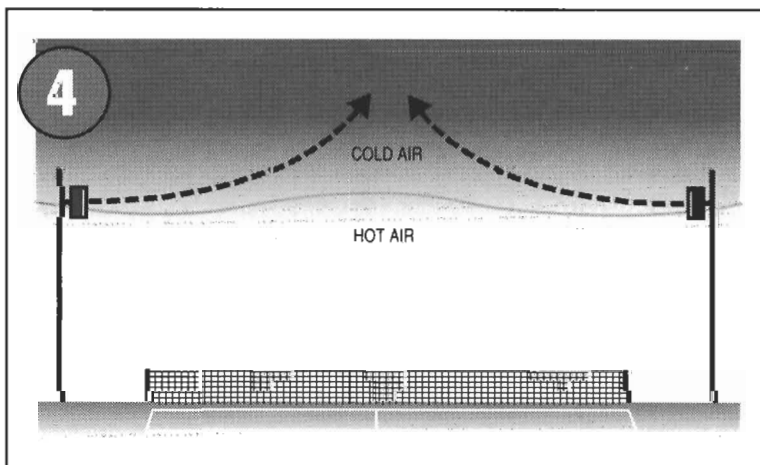
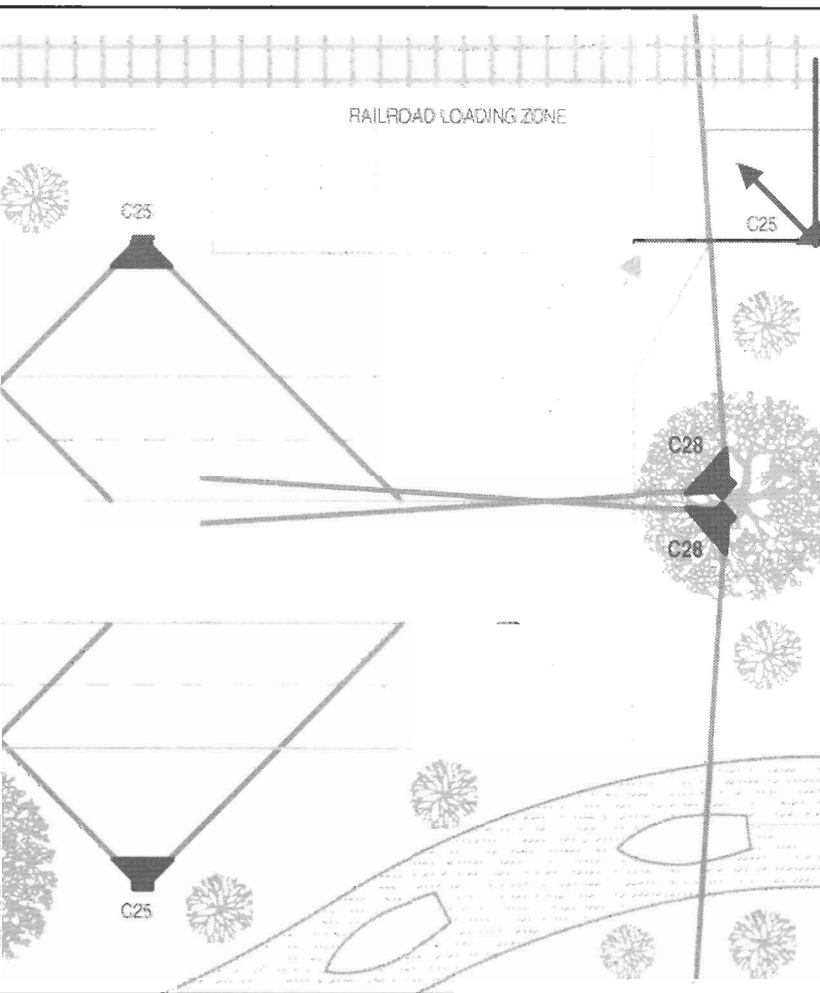

- Humidity - Because water vapor is lighter than air, humid air is less dense than dry air and, therefore absorbs less acoustical energy than dry air particularly at frequencies above 2kHz. To labour the point, a speaker mounted on a tree in a jungle will project high frequency sound further than the same speaker mounted on a cactus in the desert (see diags. 5 & 6).

### Painting the Speakers -

The polystyrene speaker enclosures of the Control® 23, Control® 25, & Control® 28 can be painted to match almost any decor. The vinyl skin of the Control® SB-2 subwoofer can also be painted.

- Remove the grilles. Mask the woofers, tweeters, & ports on the front, and the wire terminals on the back, being careful that no tape comes in direct contact with the drivers.
- Clean the enclosures with a light solvent such as mineral spirits by rubbing the components with a lightly dampened cloth. Do not, however, use abrasives such as sandpaper or steel wool on the enclosures. Nor should you use gasoline, kerosene, acetone, MEK, paint thinner, harsh detergents or other chemicals. Use of these cleaners may result in permanent damage to the enclosures.
- After cleaning, apply two or more thin coats of either latex or oil-based paints. Latex paints will adhere better if an oil-based primer is used first. Application can be by rolling, brushing, or spraying.
- The grilles require masking of the logo plug, then spray painting. If the grill is rolled or brush painted, the mesh may become clogged with paint, and poor sound quality may result.
- The *InvisiBall™* mount may also be painted, but because it is metal, latex paints will not adhere as well as other finishes.

# PRODUCT CARE MAINTENANCE

Your Control Contractor system has been designed and manufactured for durability and reliable service. As with any fine product, proper maintenance and care will extend the life of your system.

You can expect your system components to perform indefinitely if you use them within their stated limits for power handling, and see that they are not abused.

Always protect the loudspeakers from over-excursion caused by strong subsonic signals (signals below 30Hz). If your amplifier has a "low cut" or "high pass" switch, engage it.

Please note that although the C23, C25 and C28 are designed to be weather resistant they are NOT WEATHERPROOF.

Insect screens have been included in the design of the low frequency vents. It may be wise to periodically check and clear any debris collected, to ensure proper operation of the vent.

It is not unheard of for rodents to eat and destroy foam. It is recommended that the foam surrounding the SB-2 subwoofer enclosure be treated with a rodent repellent, especially in an installation that may be subject to the occasional rodent visitation.

## JBL LIMITED WARRANTY

Control Contractor products are designed and backed by JBL, the world leader in sound reinforcement. For complete JBL warranty information within the United States please refer to the warranty card enclosed with your Control Contractor product. In other areas of the world please contact your local JBL distributor.

# TROUBLESHOOTING TABLE

If none of the suggestions below solve your problem, contact your nearest JBL service center or JBL distributor.

Problem	Possible Cause(s)	Action
1. No Output.	<ul style="list-style-type: none"><li>• Speaker Cable(s)</li><li>• Amplifier</li></ul>	<ul style="list-style-type: none"><li>• Replace the cable(s) connecting the loudspeaker system and amplifier.</li><li>• Make sure the amplifier channel is being fed an input signal (preferably via a "signal input" indicator on the amp).</li><li>• Check that the amplifier channel's volume control is turned up.</li><li>• Connect the speaker and cable which had no output to another amplifier channel, making sure an input signal is fed to the new amp channel. If you then get output, the problem was the amplifier channel. If not, then the problem may be in the cable or speaker.</li></ul>
2. Questionable or intermittent output such as crackling.	<ul style="list-style-type: none"><li>• A poor connection</li></ul>	<ul style="list-style-type: none"><li>• Check all cabling for proper connector contact since a bad connection can result in intermittent contact or dramatically increased resistance which, in turn, can cause reduced output or noises unrelated to the signal.</li></ul>
3. Constant noise such as buzzing, hissing, or the humming sound.	<ul style="list-style-type: none"><li>• A faulty electronic device in the signal chain</li><li>• Poor system grounding</li></ul>	<ul style="list-style-type: none"><li>• Since loudspeakers cannot generate these sounds by themselves, you may have a faulty electronic device in the signal chain.</li><li>• Check and correct the system grounding, as required.</li></ul>
4. Poor low frequency output.	<ul style="list-style-type: none"><li>• Out-of-Polarity Hookup between multiple speakers</li></ul>	<ul style="list-style-type: none"><li>• When two speakers are hooked up out-of-polarity ("out-of-phase"), the low frequencies cancel each other out. Try reversing the polarity of one of the speakers either by turning around a dual-banana plug at the amplifier or by reversing the tip/sleeve leads on the jack. Whichever condition results in greater low-frequency output is the in-polarity condition.</li></ul>



### CONTROL® 23



The most compact of the Control Contractor Series speakers, the Control 23 is ideal for limited space environments. Despite its 188 x 138 x 108mm (7.5 x 5.5 x 4.3in) dimensions, this 50W two-way system with 87dB sensitivity delivers crisp, articulate sonic quality from 225Hz to 20kHz with no discernable phase distortion. Pairing a 3.5" woofer with a horn-loaded titanium-coated tweeter, the Control 23 is housed in a black or white HIPS (high impact polystyrene) enclosure. For venues such as restaurants, bars and retail shops, the Control 23 offers impressive sound pressure - and value - in an ultra-compact package. Accessories include the *InvisiBall™* Tool, a 4mm hex wrench.

Frequency Range: 225Hz - 20kHz (±3dB)  
 Power Capacity: 50 Watts Continuous Program  
 Sensitivity: 87dB 1W, 1m  
 Nominal Impedance: 8Ω  
 Crossover Frequency: 3.5kHz  
 Enclosure Material: HIPS (high impact polystyrene)  
 Termination: Spring clips  
 (adapted to accept dual banana plugs)  
 Dimensions (HxWxD): 188 x 138 x 108mm  
 (7.5 x 5.5 x 4.3in)  
 Net Weight (each): 1.8kg (4 lbs)  
 Shipping Weight (pair): 4.1kg (9 lbs)  
 Environmental: Conforms to Mil Std. 202F, Method 101D.

Frequency Range: 150Hz - 20kHz (±3dB)  
 Power Capacity: 150 Watts Continuous Program  
 Sensitivity: 88dB 1W, 1m  
 Nominal Impedance: 8Ω  
 Crossover Frequency: 3.0kHz  
 Enclosure Material: HIPS (high impact polystyrene)  
 Termination: Spring clips  
 (adapted to accept dual banana plugs)  
 Dimensions (HxWxD): 231 x 183 x 140mm  
 (9.5 x 7.3 x 5.6in)  
 Net Weight (each): 2.3kg (5 lbs)  
 Shipping Weight (pair): 5kg (11 lbs)  
 Environmental: Conforms to Mil Std. 202F, Method 101D.

### CONTROL® 25



In mid-range size, power and performance, the two-way Control 25 incorporates a 5.25" low frequency loudspeaker with a horn loaded 3/4" titanium-coated tweeter and 150W power capacity. Its 231 x 183 x 140mm (9.5 x 7.3 x 5.6in) size and broad performance curve make it a logical choice for sound reinforcement in moderately large retail venues, or for multiple-distribution requirements. With a frequency response range of 150Hz - 20kHz and 88dB sensitivity, it provides superior dynamic performance and a smooth roll-off down to 150Hz. It is available with a pre-installed 70V/100V autotformer for line distribution systems. Accessories include the *InvisiBall™* Tool, a 6mm hex wrench.

### CONTROL® 28



The Control 28 offers the highest power, performance, bandwidth and sensitivity available in a full-range Control Contractor Series speaker. At 175W, the two-way Control 28 incorporates an 8" low frequency transducer and 1" titanium-coated tweeter for vivid sound reproduction and clarity from 100Hz to 20kHz, with 92db sensitivity. Its 15" HIPS (high impact polystyrene) enclosure ideally balances mass and structural acoustics, and delivers exceptionally "clean" projection in the largest coverage environments. For multiple speaker systems, it is available with a factory-installed 70V/100V autotformer for line distribution systems. Accessories include the *InvisiBall™* Tool, a 6mm hex wrench.

Frequency Range: 100Hz - 20kHz (±3dB)  
 Power Capacity: 175 Watts Continuous Program  
 Sensitivity: 92dB 1W, 1m  
 Nominal Impedance: 8Ω  
 Crossover Frequency: 2.8kHz  
 Enclosure Material: HIPS (high impact polystyrene)  
 Termination: Spring clips  
 (adapted to accept dual banana plugs)  
 Dimensions (HxWxD): 375x 275x 215mm  
 (15 x 11x 8.5in)  
 Net Weight (each): 5.5kg (12 lbs)  
 Shipping Weight (pair): 11kg (25 lbs)  
 Environmental: Conforms to Mil Std. 202F, Method 101D.

### CONTROL® SB-2

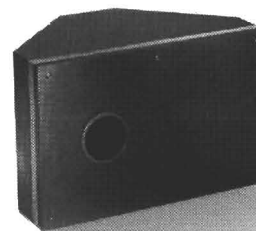

The Control SB-2 slot loading vented bandpass subwoofer, with a dual voice-coil 10" bass transducer, has been specially tuned to complement all full-range Control Contractor Series systems. The SB-2 features a unique concept in "passive attenuation" by use of the Load Baffle, a special geometric combination of rigid and pliable materials. It has stereo 8 ohm inputs with full bandwidth satellite outputs that employ spring terminal connectors that accept dual banana jacks. Mass and structural integrity are balanced for a distortion-free low end in 575 x 375 x 288 mm (15 x 23 x 11.5 in) black vinyl-wrapped wooden trapezoidal enclosures.

### MTC-2H SERIES BRACKETS

The MTC-2H series mounting kit allows two Control speakers to be horizontally wall-mounted with splay angles of 120°. Ganging three MTC-2H brackets forms a 360° array suspension mount of up to six speakers.



### MTC-2V SERIES BRACKETS

Allows up to three Control speakers to be wall-mounted, directing sound to specific, separate levels. Made from mild steel and available in flat black, these brackets utilize the unique and patent-pending *InvisiBall™*.

When vertically mounted, speakers can be attached end-to-end in a tight attractive column that directs on-axis sound of each speaker 10° apart. Versatile slots in the bracket allow the speakers to be rotated as much as 30° to cover larger vertical planes.



A Harman International Company

© 1996 JBL PROFESSIONAL, 8500 BALBOA BLVD. NORTHRIDGE • CA 91329