



HARDWARE REFERENCE MANUAL

ENOVA[®] DIGITAL MEDIA SWITCHERS

ENOVA DGX 100 SERIES ENCLOSURES
ENOVA DGX INPUT BOARDS
ENOVA DGX OUTPUT BOARDS
ENOVA DGX EXPANSION BOARDS



AV FOR AN IT WORLD

IMPORTANT SAFETY INSTRUCTIONS

1. READ these instructions.
2. KEEP these instructions.
3. HEED all warnings.
4. FOLLOW all instructions.
5. DO NOT use this apparatus near water.
6. CLEAN ONLY with dry cloth.
7. DO NOT block any ventilation openings. Install in accordance with the manufacturer's instructions.
8. DO NOT install near any heat sources such as radiators, heat registers, stoves, or other apparatus (including amplifiers) that produce heat.
9. DO NOT defeat the safety purpose of the polarized or grounding type plug. A polarized plug has two blades with one wider than the other. A grounding type plug has two blades and a third grounding prong. The wider blade or the third prong are provided for your safety. If the provided plug does not fit into your outlet, consult an electrician for replacement of the obsolete outlet.
10. PROTECT the power cord from being walked on or pinched, particularly at plugs, convenience receptacles, and the point where they exit from the apparatus.
11. ONLY USE attachments/accessories specified by the manufacturer.
12. USE ONLY with a cart, stand, tripod, bracket, or table specified by the manufacturer; or sold with the apparatus. When a cart is used, use caution when moving the cart/apparatus combination to avoid injury from tip-over:



13. UNPLUG this apparatus during lightning storms or when unused for long periods of time.
14. REFER all servicing to qualified service personnel. Servicing is required when the apparatus has been damaged in any way, such as power-supply cord or plug is damaged, liquid has been spilled or objects have fallen into the apparatus, the apparatus has been exposed to rain or moisture, does not operate normally, or has been dropped.
15. DO NOT expose this apparatus to dripping or splashing and ensure that no objects filled with liquids, such as vases, are placed on the apparatus.
16. To completely disconnect this apparatus from the AC Mains, disconnect the power supply cord plug from the AC receptacle.
17. Where the mains plug or an appliance coupler is used as the disconnect device, the disconnect device shall remain readily operable.
18. DO NOT overload wall outlets or extension cords beyond their rated capacity as this can cause electric shock or fire.



The exclamation point, within an equilateral triangle, is intended to alert the user to the presence of important operating and maintenance (servicing) instructions in the literature accompanying the product.



The lightning flash with arrowhead symbol within an equilateral triangle is intended to alert the user to the presence of uninsulated "dangerous voltage" within the product's enclosure that may be of sufficient magnitude to constitute a risk of electrical shock to persons.



ESD Warning: The icon to the left indicates text regarding potential danger associated with the discharge of static electricity from an outside source (such as human hands) into an integrated circuit, often resulting in damage to the circuit.

- WARNING: To reduce the risk of fire or electrical shock, do not expose this apparatus to rain or moisture.
- WARNING: No naked flame sources - such as lighted candles - should be placed on the product.
- WARNING: Equipment shall be connected to a MAINS socket outlet with a protective earthing connection.
- WARNING: To reduce the risk of electric shock, grounding of the center pin of this plug must be maintained.

COPYRIGHT NOTICE

AMX© 2018, all rights reserved. No part of this publication may be reproduced, stored in a retrieval system, or transmitted, in any form or by any means, electronic, mechanical, photocopying, recording, or otherwise, without the prior written permission of AMX. Copyright protection claimed extends to AMX hardware and software and includes all forms and matters copyrightable material and information now allowed by statutory or judicial law or herein after granted, including without limitation, material generated from the software programs which are displayed on the screen such as icons, screen display looks, etc. Reproduction or disassembly of embodied computer programs or algorithms is expressly prohibited.

LIABILITY NOTICE

No patent liability is assumed with respect to the use of information contained herein. While every precaution has been taken in the preparation of this publication, AMX assumes no responsibility for error or omissions. No liability is assumed for damages resulting from the use of the information contained herein. Further, this publication and features described herein are subject to change without notice.

AMX WARRANTY AND RETURN POLICY

The AMX Warranty and Return Policy and related documents can be viewed/downloaded at www.amx.com.

WARNING: This product is intended to be operated ONLY from the voltages listed on the back panel or the recommended, or included, power supply of the product. Operation from other voltages other than those indicated may cause irreversible damage to the product and void the products warranty. The use of AC Plug Adapters is cautioned because it can allow the product to be plugged into voltages in which the product was not designed to operate. If the product is equipped with a detachable power cord, use only the type provided with your product or by your local distributor and/or retailer. If you are unsure of the correct operational voltage, please contact your local distributor and/or retailer.

BATTERY INSTRUCTIONS

THIS PRODUCT CONTAINS A LITHIUM PACK OR COIN/BUTTON CELL BATTERY. IF MISUSED OR ABUSED THIS CAN RESULT IN:

- Smoke or gas hazard
- Heat hazard
- Fire hazard
- Explosion hazard



WARNING: Do not place batteries in mouth or ingest. Chemical burn hazard. Keep new and used batteries out of reach of children and pets. If swallowed, it can cause severe internal burns in just 2 hours and can lead to death.

If you think batteries might have been swallowed or placed inside any part of the body, seek immediate medical attention.

WARNING: If battery compartment does not close securely, stop using the product and keep it away from children and pets.

WARNING: Do not handle leaking or damaged Lithium batteries.

WARNING: Risk of leakage. Only use the specified type of batteries. Never mix new and used batteries.

Observe correct polarity. Remove batteries from products that are not in use for extended periods of time. Store batteries in a dry place.

WARNING: Batteries (battery pack or batteries installed) shall not be exposed to excessive heat such as sunshine, fire or the like.

WARNING: Danger of explosion if battery is incorrectly replaced. Replace only with the same or equivalent type.

Dispose of used batteries according to the instructions.

WARNING: Do not recharge non-rechargeable batteries.

WARNING: Avoid exposure to extreme heat or cold.

Please dispose of any used batteries properly, following any local regulations. Do not incinerate.

EU COMPLIANCE INFORMATION

Eligible to bear the CE mark; Conforms to European Union Low Voltage Directive 2014/35/EU; European Union EMC Directive 2014/30/EU; European Union Restriction of Hazardous Substances Recast (RoHS2) Directive 2011/65/EU; European Union WEEE (recast) Directive 2012/19/EU; European Union Eco-Design Directive 2009/125/EC; European Union Registration, Evaluation, Authorization and Restriction of Chemicals (REACH) Regulation (EC) 1907/2006.

You may obtain a free copy of the Declaration of Conformity by visiting <http://www.amx.com/techcenter/certifications.asp>.

WEEE NOTICE



This appliance is labeled in accordance with European Directive 2012/19/EU concerning waste of electrical and electronic equipment (WEEE). This label indicates that this product should not be disposed of with household waste. It should be deposited at an appropriate facility to enable recovery and recycling.

US FCC COMPLIANCE NOTICE - CLASS A

NOTE: This equipment has been tested and found to comply with the limits for a Class A digital device, pursuant to part 15 of the FCC Rules. These limits are designed to provide reasonable protection against harmful interference when the equipment is operated in a commercial environment. This equipment generates, uses, and can radiate radio frequency energy, and if it is not installed and used in accordance with the instruction manual, it may cause harmful interference to radio communications. Operation of this equipment in a residential area is likely to cause harmful interference, in which case the user will be required to correct the interference at his own expense.

US FCC AND CANADA EMC COMPLIANCE INFORMATION:

This device complies with part 15 of the FCC Rules. Operation is subject to the following two conditions:

- (1) This device may not cause harmful interference, and (2) this device must accept any interference received, including interference that may cause undesired operation.

CANADA ICES INFORMATION

ICES (Interference-Causing Equipment Standard): CAN ICES-3 (A)/NMB-3(A)

ESD WARNING



To avoid ESD (Electrostatic Discharge) damage to sensitive components, make sure you are properly grounded before touching any internal materials.

When working with any equipment manufactured with electronic devices, proper ESD grounding procedures must be followed to make sure people, products, and tools are as free of static charges as possible. Grounding straps, conductive smocks, and conductive work mats are specifically designed for this purpose.

Anyone performing field maintenance on AMX equipment should use an appropriate ESD field service kit complete with at least a dissipative work mat with a ground cord and a UL listed adjustable wrist strap with another ground cord.

These items should not be manufactured locally, since they are generally composed of highly resistive conductive materials to safely drain static charges, without increasing an electrocution risk in the event of an accident.

LICENSE NOTICES AND TRADEMARK ACKNOWLEDGMENTS

Java[®] is a registered trademark of Oracle and/or its affiliates.

Manufactured under license from Dolby Laboratories. Dolby[®] and the double-D symbol are registered trademarks of Dolby Laboratories.

DTS[®], the Symbol, DTS-HD[®], and DTS[®] or DTS-HD[®] and the Symbol together are registered trademarks of DTS, Inc., and all other DTS[®] logos are trademarks of DTS, Inc.

Windows[®] and Internet Explorer[®] are registered trademarks of Microsoft Corporation in the United States and other countries.

Google Chrome[®] is a registered trademark of Google Inc.

Firefox[®] is a registered trademark of the Mozilla Foundation.

Safari[®] is a registered trademark of Apple Inc.

Opera[®] is a registered trademark of Opera Software ASA.

UL[®] and the UL logo are trademarks of UL LLC.

3M[®], Desco[®], Richmond Technology[®], and Plastic Systems[®] are registered trademarks.

Ethernet[®] is a registered trademark of the Xerox Corporation.

ENERGY STAR[®] is a registered trademark of the U.S. Department of Energy and the U.S. Environmental Protection Agency.

Other products mentioned herein may be the trademarks of their respective owners.

TRADEMARK LOGOS



CHINA MARKINGS (ONLY FOR INSTALLATIONS LOCATED IN CHINA)



该设备的设计和测试是在海拔 2000 米高度以下进行的，它只适用在海拔 2000 米以下的地区。在海拔 2000 米以上使用可能会导致潜在的安全隐患。

This symbol denotes that the device is not to be used at altitudes exceeding 2000 meters.



该设备的设计和测试是在非热带气候条件进行的，它只适用在非热带气候的地区。在热带气候地区使用可能会导致潜在的安全隐患。

This symbol denotes that the device is only to be used in climate regions that are not-tropical.

Table of Contents

Enova DGX 100 Series - Overview	25
Applicability Notice.....	25
DGX Digital Media Switchers & Standard Video Input and Output Boards.....	25
Enova DGX HDMI 4K60 Boards.....	25
Enova DGX HDMI Boards	25
Enova DGX DVI Boards.....	25
Enova DGX DXLink Twisted Pair Boards	25
Enova DGX DXLink Twisted Pair 4K Boards.....	26
Enova DGX DXLink Fiber Boards	26
Input and Output Boards and Signal Types.....	26
Input and Output Board Connectors	26
Connectors and Signal Types	27
Enova DGX Expansion Boards.....	27
Audio Switching Board (ASB-DAN and ASB) Sets (page 164).....	27
Enova DGX Audio Insert/Extract Board (page 175).....	27
Important Notes on Using Expansion Boards.....	28
Integrated NetLinX NX Master Functionality	28
Network Connection.....	28
DHCP Server	28
Opening Public LAN and ICS LAN Sockets from Code.....	28
Integrated NetLinX NX Master Features	28
The integrated NetLinX NX Master supports the following features:.....	28
Automatic Configuration of AMX Devices via ICS LAN	28
Link-local Fallback in DHCP Mode (IPv4 Only)	29
Wired 802.1x Support.....	29
Support for IPv6 Network Addressing.....	29
ID Pushbutton.....	29
Case Sensitive File System.....	29
USB Program Port Driver	29
Differences in DEFINE_PROGRAM Execution	29
Enova DGX NetLinX and Control Specifications	30
Configuration Information and Control Options.....	30
Switching Configuration Information	30
Embedded Audio Signals.....	30
Available Levels (Virtual Matrices)	31
Audio Switching Boards.....	31
Board Configuration Information	31
Control Options	31
Integrated NetLinX NX Central Control Processor.....	31
Control Panel.....	31
AMX Control Devices	31
BCS (Basic Control Structure) Protocol	31
Third-Party Controllers	31
Enova DGX 100 Series and Enova DGX 8/16/32/64: Differences	32
System Diagnostic Options	33
System Configuration Interface - Status Page	33
DGX_SHELL Commands	33
InstaGate Pro Technology.....	34

DGX 800	35
Front Panel	35
Power Indicator LED Behavior	35
Rear Panel	35
Power Supplies (x2)	35
Specifications	36
DGX 1600	37
Front Panel	37
Power Indicator LED Behavior	37
Rear Panel	37
Power Supplies (x2)	37
Specifications	38
DGX 3200	39
Front Panel	39
Power Indicator LED Behavior	39
Rear Panel	39
Power Supplies (x2)	39
Specifications	40
DGX 6400	41
Front Panel	41
Power Indicator LED Behavior	41
Rear Panel	42
Power Supplies (x4)	42
Specifications	43
Installation and Setup	44
DGX Enclosure MAC Address / Serial Number	44
DXLink Fiber Boards	44
Safety Recommendations for Laser Products	44
General Hazard Precautions	44
Elevated Operating Temperature	44
Airflow Restriction	44
Mechanical (Rack) Loading	45
Circuit Overloading	45
Reliable Earthing (Grounding)	45
Site Recommendations	45
Environment	45
Chassis Accessibility	45
Power	45
System Setup with Transmitters and Receivers	45
Options for System Setup with DXLink Twisted Pair	45
Options for System Setup with DXLink Twisted Pair 4K	46
Options for System Setup with DXLink Fiber	46
Unpacking	46
Unpacking Tips	46
Rack Installation and System Setup	47
Required Items	47
Optional Items	47
Recommendations	47
Installation Procedure	47

Rack-Mounting Enova DGX 100 Series Enclosures	48
Rack-Mounting DGX 6400 Enclosures	48
Rack-Mounting DGX 800/1600/3200 Enclosures	49
Installing Boards, Connecting Devices and Powering up the DGX Enclosure	49
Special Information for Audio Expansion Boards	49
Installation Options	50
Attaching Cable Management Bars	50
Attaching Video Input and Output Cables.....	51
Enova DGX 800.....	51
Enova DGX 1600.....	51
Enova DGX 3200.....	51
Enova DGX 6400.....	51
Cabling Specific Connector Types	51
Input and Output Signal Cables	51
Wiring Audio Inputs and Outputs	52
System Setup for Using the Integrated NetLinx NX Master	52
System Setup Overview.....	52
RJ-45 Ports	53
RJ-45 Port LEDs	53
ICS LAN 10/100 and LAN 100/1000 Indicator LEDs	53
Cable Requirements and Pinouts	53
T568A.....	53
T568B.....	54
ICS LAN 10/100 Port.....	54
LAN 100/1000 Port.....	54
IP Protocols Used by the Enova DGX Integrated Controller.....	54
Avoiding Network (Ethernet) Loops.....	55
Connecting an Enova DGX to a Public LAN via the LAN 100/1000 Port	56
Confirming Board Versions	56
System Configuration Interface Setup.....	57
System Requirements.....	57
Logging On To the System Configuration Interface and Executing a Test Switch	57
Additional Setup Options	57
Audio Control and Signal Processing Options.....	58
Audio Switching Boards (ASB).....	58
System Configuration Interface	58
ICSP Commands	58
Control Panel.....	58
BCS Commands	58
Establishing Serial Communication with a PC via the Program Port.....	58
Program Port	58
Cable Requirements.....	58
Program Port LEDs – Modes and LED Blink Patterns	58
Attaching an AxLink Device	59
AxLink LED	59
Using the AxLink Connector for Data and Power	59
AxLink Device Numbering	59
Setting an AxLink Device Address.....	60
AxLink Power Measurement and Control.....	60
AxLink Port Diagnostics	60
Using the ID Pushbutton	60
Toggling Between DHCP and Static IP Addressing	60

Resetting the Factory Default Settings:	60
Restoring the Factory Firmware Image and Factory Default Settings	61
Program Run Disable (PRD) Mode	61
Setting the Config DIP Switch To Place the Integrated Master in PRD Mode	61
Troubleshooting and Technical Support	61
Troubleshooting	61
Enova DGX Switcher Hardware Troubleshooting	61
Video and Audio Troubleshooting	62
AMX Software Troubleshooting	62
Contacting Technical Support	62
AMX Contact Information	62
Applying Power and Startup	63
Overview	63
Power Budget Planning for Systems with DXLink Twisted Pair Boards	63
Complete Power Redundancy Setup	63
Power-Up Sequence	63
Applying Power	64
Indicator Lights at Startup	64
Redundant Power Supply (RPS)	65
Power Supply Troubleshooting	65
CPU/Control Board (all DGX 100 Series Enclosures)	66
Overview	66
Control Panel	67
Overview	67
Control Keys and Dial	67
Input and Output Keys	68
Function Menus and Modes	68
Enova DGX Control Panel - Basic Tasks	69
Labeling Input and Output Keys	69
Creating and Installing Custom Labels for Input and Output Keys	69
Executing Switches	70
Executing a Test Switch	70
Controlling Switches on Systems with Audio Switching Boards	70
Changing the Virtual Matrix	71
Changing the Virtual Matrix	71
Disconnecting Switches	71
Disconnecting Inputs and Outputs	71
Verifying Signal Status	72
Defining and Executing Global Presets	72
Systems without Audio Switching Boards (ASB or ASB-DAN)	73
Systems with Audio Switching Boards (ASB or ASB-DAN)	73
Defining a Global Preset	73
Executing a Global Preset	73
Locking and Unlocking	74
Locking the Control Panel	74
Unlocking the Control Panel	74
Adjusting Audio (Systems with Audio Switching Boards Only)	74
Audio Adjustments on the Control Panel	75
Adjusting Volume	75

Muting and Unmuting Outputs	75
Unmuting an Output While In Mute Mode	76
Adjusting Input Gain	76
Setup Options	76
Software Version	77
Checking Software Version Information.....	77
Master Info	77
Checking Integrated Master Info	77
Default Virtual Matrix.....	78
Reload Config	78
Setting the Password	79
System Error Codes and Troubleshooting	79
Enabling Error Code Reporting	80
Turning Error Code Reporting Off	80
Error Code Troubleshooting	80
4K60 HDMI Input & Output Boards	81
Overview.....	81
Signal Routing	81
DGX Board Compatibility	81
4K60 Signal Routing	82
Video Signal Tiers Support	82
3rd Party Equipment Requirements for DGX 4K60 HDMI Boards	82
Enova DGX 4K60 4:4:4 HDMI Input Board - Specifications	83
Enova DGX 4K60 4:4:4 HDMI Output Board - Specifications	84
4K60 HDMI Board Default EDID Resolutions Supported through Local DDC.....	85
4K HDMI DTD (Detailed Timing Descriptor)	85
4K HDMI CTA Video Information Code (VIC) Formats	85
Audio Data Block.....	86
4K60 HDMI Board EDID Resolutions - 50 Hz and 60 Hz Modes	86
Detailed Timings	86
HDMI VICs	86
Short Video Descriptors	86
4K HDMI Standard Timings	87
4K HDMI Established Timings	87
Standard Timings	87
Established Timings	87
Audio Data Block.....	87
Attaching HDMI Connectors	88
Executing a Test Switch for an HDMI Board.....	88
HDCP Support on Enova DGX 4K60 Switchers.....	88
Video Troubleshooting.....	89
Audio Troubleshooting	91
Determining the DxLink Transmitter Source Audio Port	94
Audio Format Support on Enova DGX Boards	94
HDMI Input & Output Boards	95
Overview.....	95
Signal Routing	95
4K Signal Routing	95
InstaGate Pro and SmartScale	96

Enova DGX HDMI Input Board - Specifications	96
Enova DGX HDMI Output Board - Specifications	99
HDMI Board EDID Resolutions Supported via Local DDC	100
Standard Timings (Default Shipping EDID)	100
Established Timings	100
HDMI CTA Video Information Code (VIC) Formats.....	101
Audio Data Block	101
4K HDMI Board EDID Resolutions Supported through Local DDC	101
4K HDMI DTD (Detailed Timing Descriptor)	101
4K HDMI Standard Timings.....	102
4K HDMI Established Timings	102
4K HDMI CTA Video Information Code (VIC) Formats	102
Audio Data Block	102
Attaching HDMI Connectors	103
Executing a Test Switch for an HDMI Board	103
HDCP Support on Enova DGX Switchers	103
HDMI System Conditions	103
Steps in the Content Protection Process	103
Supported Number of Sinks	104
HDCP Source Device	104
Enova DGX Switcher.....	104
Unsuccessful Transmission in System	104
Video Troubleshooting	104
Audio Troubleshooting	105
Audio Format Support on Enova DGX Boards	105
DVI Input & Output Boards	106
Overview.....	106
Signal Routing	106
InstaGate Pro and SmartScale	106
Audio Support on DVI Boards	107
Enova DGX DVI Boards - Specifications	107
EDID Resolutions Supported through Local DDC	108
Standard Timings (Default shipping EDID)	108
Established Timings	108
CTA Video Information Code (VIC) Formats	109
Audio Data Block	109
Connecting DVI Inputs and Outputs	109
DVI Pinout	110
Troubleshooting Video	110
Troubleshooting Audio	111
Audio Format Support on Enova DGX Boards	111
DXLink Twisted Pair Input and Output Boards	112
Overview.....	112
Signal Routing	112
HDCP Compliance.....	112
InstaGate Pro Technology	113
DXLink - Twisted Pair Boards Specifications	113
Compatible AMX DXLink - Twisted Pair Transmitters and Receiver	113

Compatible AMX Solecis Digital Switchers (1 Output per Switcher)	113
EDID Resolutions Supported through Local DDC	114
Standard Timings (Default Shipping EDID)	114
Established Timings	115
CTA Video Information Code (VIC) Formats	115
Audio Data Block.....	115
System Setup with DXLink Transmitters and Receivers.....	116
Options for DXLink System Setup.....	116
DXLink Transmitter/Receiver Grounding.....	116
Example of Typical Setup with DXLink Transmitter and Receiver.....	116
Functions of DXLink Transmitters and Receivers	117
Important Power Considerations for Enova DGX 3200 Endpoint Systems	118
Power Budget Planning for Enova DGX 3200 with DXLink Boards	118
Power Budget Calculation	118
Foregoing Power Supply Redundancy	118
In the Event of a Power Supply Failure.....	118
Connecting Switching Systems with DXLink Connectors.....	119
Avoiding Network (Ethernet) Loops	119
Important Twisted Pair Cabling Requirements and Recommendations	119
Twisted Pair Cable Pinouts	119
Connecting Sources and Destinations to DXLink Inputs and Outputs via TX/RX	119
DXLink Connector LEDs.....	120
Configuring DXLink Endpoints for Communication with a Master	120
Best Practices for Configuration	120
DIP Switch Toggles.....	120
Auto-setup.....	121
Need to Know for Auto-setup	121
Disabling Auto-setup Mode	121
Enabling Auto-setup Mode	121
Enable Auto-setup Mode via DGX_SHELL Commands	121
Telnet Access to Endpoints in Auto-setup Mode.....	121
Telnet Access to DXLink Endpoints	122
Serial Data Transfer and IR Flow Control.....	122
DXLink Twisted Pair / DXLink Twisted Pair 4K Compatibility	122
Troubleshooting Audio	122
DXLink Twisted Pair 4K Input and Output Boards	123
Overview.....	123
Signal Routing	123
HDCP Compliance.....	124
InstaGate Pro Technology	124
DXLink Twisted Pair 4K Boards Specifications	124
Compatible AMX DXLink- Twisted Pair 4K Transmitters and Receivers:	124
Compatible AMX Solecis 4K Digital Switchers (1 Output per Switcher):.....	124
EDID Resolutions Supported through Local DDC	125
DTD (Detailed Timing Descriptor).....	125
Standard Timings	126
Established Timings	126
CTA Video Information Code (VIC) Formats	126
Audio Data Block	127
System Setup with DXLink Twisted Pair 4K Transmitters and Receivers.....	127

Options for DXLink System Setup.....	127
Example of Typical Setup with DXLink Twisted Pair 4K Transmitter and Receiver	127
Functions of DXLink Transmitters and Receivers	128
Important Power Considerations for Enova DGX 3200 Endpoint Systems	128
Power Budget Planning for Enova DGX 3200 with DXLink Boards	129
Power Budget Calculation	129
Foregoing Power Supply Redundancy	129
In the Event of a Power Supply Failure.....	129
Connecting Switching Systems with DXLink Connectors.....	129
Avoiding Network (Ethernet) Loops	130
Important DXLink Twisted Pair 4K Cabling Requirements and Recommendations.....	130
Twisted Pair Cable Pinouts	130
Connecting Sources and Destinations to DXLink Inputs and Outputs via TX/RX	130
DXLink Connector LEDs.....	131
Configuring DXLink Endpoints for Communication with a Master	131
Best Practices for Configuration	131
DIP Switch Toggles.....	131
Auto-setup.....	132
Need to Know for Auto-setup	132
Disabling Auto-setup Mode	132
Enabling Auto-setup Mode	132
Telnet Access to Endpoints in Auto-setup Mode.....	132
Telnet Access to DXLink Twisted Pair 4K Receivers.....	132
DXLink Twisted Pair / DXLink Twisted Pair 4K Compatibility	133
Troubleshooting	133
DXLink Fiber Input & Output Boards	134
Overview.....	134
DXLink Fiber Boards, Duplex	134
DXLink Fiber Boards, Simplex.....	134
Warning: Optical Fiber Products	135
OSHA Directive	135
Signal Routing	135
HDCP Compliance.....	135
InstaGate Pro Technology	135
DXLink Fiber Hardware Compatibility	135
Compatible DXLink Fiber Transmitters and Receivers	135
DXLink Fiber Directional Modes	136
Bidirectional Mode	136
Unidirectional Mode	136
Data Link-lost Mode	136
Enova DGX DXLink Fiber Boards Specifications.....	136
EDID Resolutions Supported through Local DDC	138
Standard Timing Identification (Default Shipping EDID).....	138
Established Timing.....	138
CTA Video Information Code (VIC) Formats	138
Audio Data Block	139
System Setup with DXLink Fiber, Duplex and Simplex Units.....	139
Destination Device Support Problems.....	140
Connecting Switching Systems with DXLink Fiber Connectors.....	140
Attaching Cables.....	140

OSHA Directive	140
Wiring for Directional Modes	140
Fiber Optic Cable Wiring for Bidirectional Mode – Duplex Only (Default).....	140
Fiber Optic Cable Wiring for Unidirectional Mode – Simplex (Default) or Duplex (Configurable).....	141
Fiber Optic Cable Wiring for Data Link-lost Mode – Duplex Only	141
Fiber Optic Transceivers	141
Board Types / Cable Types / Cable Runs.....	141
Fiber Optic Cable Requirements	141
Connecting DXLink Fiber Inputs and Outputs	141
Fiber Optic Transceiver LEDs in Duplex and Simplex Hardware	142
Transceiver LEDs in Bidirectional Mode - Duplex Only	142
Transceiver LEDs in Unidirectional Mode - Simplex (Default) or Duplex (Configurable)	143
Duplex Hardware Directional Mode Configuration	143
Hardware Configuration.....	143
Configuring DXLink Duplex Hardware for Unidirectional Communication	143
DXLink Fiber Inputs or Outputs	144
Units Connected to DXLink Board Connectors.....	144
Configuring DXLink Duplex Hardware for Bidirectional Communication	144
DXLink Fiber Inputs or Outputs	144
Units Connected to DXLink Board Connectors.....	144
Checking DXLink Fiber, Duplex Hardware Directional Mode Settings	144
Configuring DXLink Endpoints for Communication with a Master	144
Auto-setup	144
DIP Switch Toggles.....	144
Auto-setup.....	145
Disabling Auto-setup Mode	145
Enabling Auto-setup Mode	145
Telnet Access to Endpoints in Auto-setup Mode.....	145
Telnet Access to DXLink Endpoints	145
Serial Data Transfer and IR Flow Control.....	146
Replacing an SFP+ Fiber Optic Transceiver	147
Items Required.....	147
Multimode SFP+ Fiber Optic Transceiver	147
Single Mode SFP+ Fiber Optic Transceiver.....	147
Fiber Transceiver Replacement	147
Removing/Replacing SFP+ Fiber Optic Transceivers	148
DXLink Fiber Troubleshooting.....	148
General Signal Problems	148
Audio Problems.....	148
Audio not present or intermittent with good video:.....	148
Other audio problems:.....	148
Video Problems	148
Verify Optical Signal - Multimode Transceivers Only	148
Verify Bidirectional Mode Fiber Path - Duplex Only	149
Verify Unidirectional Mode Fiber Path	149
Verify Auto-setup Mode.....	149
Dante Audio Switching Boards	150
Overview.....	150
Dante Technology.....	150
Dante Network Configuration Considerations	150
Dante Audio Switching Boards Rules for System Setup	150

Enova DGX Model Specific Dante Audio Switching Board Location	151
Dante Audio Switching Boards Specifications	152
System Examples	153
Daisy Chain Topology (Default).....	153
Star Topology without Redundancy	155
Star Topology with Redundancy	155
Dante Audio Switching Board Numbering Overlays.....	156
Applying Dante ASB Overlays to Numbering Plates	156
Dante Audio Switching Board Overlay Placement.....	156
Enova DGX Dante ASB to Dante Subscription Mapping	157
Enova DGX 800 Path Mapping	157
Enova DGX 1600 Path Mapping	157
Enova DGX 3200 Path Mapping	157
Enova DGX 6400 Path Mapping	158
Attaching Cables.....	158
Dante Audio Switching Board Connectors	158
Dante Audio Switching Board LEDs	159
Attaching the HSSI SMA (Sub-miniature version A) Cable.....	159
Routing Audio Signals.....	160
Audio Routing Capability	160
System Configuration interface - Audio Virtual Matrix (VM 2).....	160
Audio Matrix I/O Paths.....	160
Testing/Checking Audio Signal Routing.....	161
Digital Signal Processing (DSP)	161
Input and Output Digital Signal Processing	161
down-mix Audio Input.....	162
Dante Audio Switching Board down-mix Input	162
Supported down-mix Input Formats.....	162
Routing the down-mix Input	162
down-mix SEND_COMMANDS	162
Dante Audio Switching Board Troubleshooting	162
Switching speed or command response slows after adding Dante ASBs to the enclosure:	162
Cannot find the Dante Audio Switching Board in Dante Controller:.....	162
To determine which physical Dante device corresponds to an entry in Dante Controller:	162
Down-mixed audio is not present or is intermittent with good video:.....	163
Dante Audio Switching Board defaults to "Embedded" rather than "Switched" audio:.....	163
If you lose audio at destinations and in Dante Virtual Soundcard / Dante Via:	163
ASB Audio Switching Boards	164
Overview.....	164
Rules for System Setup	164
Enova DGX Model Specific Audio Switching Board Location	165
Enova DGX Audio Switching Boards - Specifications.....	166
System Examples	167
Embedded Audio - Replacing Embedded Audio on Video Signals.....	167
Audio Only - Audio Only from Source to Destination Device	167
All Audio (Embedded or Audio Only) - Routing to Differing Types of Destination Devices	168
Audio Switching Board Numbering Overlays	168
Applying ASB Overlays to Numbering Plates	168
Audio Switching Board Overlay Placement	169
Attaching Wires/Cables.....	169

Audio Switching Board Connectors	169
Attaching Terminal Block Audio Connectors.....	169
Important to Know When Wiring Audio Switching Board Terminal Block Connectors	169
Wiring Audio Connectors.....	169
Options for Wiring ASB Boards to Source and Destination Devices.....	170
Attaching the HSSI SMA (Sub-miniature version A) Cable.....	171
Routing Audio Signals.....	171
Audio Routing Capability	171
System Configuration interface - Audio Virtual Matrix (VM 2).....	171
Audio Matrix I/O Paths.....	171
Testing/Checking Audio Signal Routing.....	172
Digital Signal Processing (DSP).....	172
Input and Output Digital Signal Processing	173
Stereo Audio.....	173
down-mix Audio Input.....	173
Audio Switching Board down-mix Input	173
Supported down-mix Input Formats.....	173
Routing the down-mix Input	174
down-mix SEND_COMMANDs	174
Audio Switching Board Troubleshooting	174
AIE Audio Insert/Extract Boards	175
Overview.....	175
Rules for System Setup	175
Enova DGX Model Specific AIE Notes.....	176
Enova DGX Audio Insert/Extract Boards - Specifications	176
System Examples	177
AIE Board in Left Expansion Board Slot - Extract Function	177
AIE Board in Left Expansion Board Slot - Insert Function	177
AIE Board in Right Expansion Board Slot - Insert Function	177
AIE Board in Right Expansion Board Slot - Extract Function	178
AIE Boards in Both Expansion Board Slots - Insert and Extract Functions.....	178
Setting Audio Connectors to Insert or Extract	178
Removing an AIE Board	179
Setting the DIP Switches.....	180
Enable/Disable DIP Switches	180
Extract/Insert DIP Switches	180
Reinstalling an AIE Board	180
Enova DGX 6400 Only - AIE Board Numbering Overlays	181
Applying Overlays to AIE Board Faceplates.....	181
Attaching Wires	181
Wiring AIE Boards	181
Wiring Audio Connectors.....	182
Testing/Checking the Insert/Extract Functionality.....	182
AIE Board Troubleshooting.....	182
Options for Wiring AIE to Balanced Audio Input Device	183
Standard Wiring.....	183
If Necessary – Wiring to Eliminate Buzzing.....	183
System Configuration Interface	184
Overview.....	184

Accessing the System Configuration Interface	184
Username and Password.....	184
System Configuration Interface Tips	184
Menu Bar	185
Home Page	185
Switching Page	185
Switching Page Components	185
Color-Coded Switch Selection and Switching Orientation	186
Legend Page	187
Group Restore to Default - Warning dialog	187
Switch Mode	188
Executing a Switch.....	188
Configuring/Switching the Down-mix Signal.....	188
Designating an Input for Down-mixing (Configuration page)	189
Configuration Page	189
Configuration Page Components.....	189
Video Input and Output Details Windows	190
Video Settings	191
Inputs Only - General	191
Inputs Only - HDCP Setting	192
Outputs Only - General	192
Setting a Manual Override for a Scaled Output.....	192
Display Settings	192
On-Screen Display	193
Image Adjustments	193
DXLink Video Settings	194
.....DXLink (Twisted Pair or Fiber) Transmitters (for selected video input)	194
DXLink (Twisted Pair or Fiber) Receivers (for selected video output).....	195
Audio Settings	195
Inputs Only - General	195
Compression	196
Outputs Only - General	196
Levels & Delay	196
10-Band Parametric Equalizer	197
DXLink Audio Settings	197
.....DXLink (Twisted Pair or Fiber) Transmitter (for selected audio input)	197
DXLink TX Details	198
.....DXLink (Twisted Pair or Fiber) Receivers (for selected audio output)	198
DXLink RX Details	199
EDID Configuration.....	199
Setting an Enova Standard EDID For an Input	199
Setting a Custom EDID from an Output Sink.....	199
Setting the EDID Mode For an Audio Input.....	199
Loading and Saving EDIDs.....	200
Status Page.....	200
System Configuration Interface Tips.....	201
NetLinx Studio	202
Overview.....	202
Installing NetLinx Studio and Connecting to a Master	202
System Requirements	202
Installing NetLinx Studio.....	202
Connecting To a NetLinx Master.....	202

Confirming Board Versions	203
Confirm Board Versions	203
Sending a Firmware .kit File to the Enclosure.....	203
Enabling Control Characters in a Terminal or Telnet Session.....	203
NetLinx Studio Tips.....	203
Integrated Master - NetLinx Programming	204
Overview.....	204
Device Numbering.....	204
Enclosure Port Mapping	205
Enova DGX 800 Port Mapping	205
Enova DGX 1600 Port Mapping	205
Enova DGX 3200 Port Mapping	206
Enova DGX 6400 Port Mapping	207
NetLinx Channels and Levels	208
NetLinx Channels	208
NetLinx Levels	209
Digital Media Switchers: SEND_COMMANDs	209
Note the following port information:	209
Switcher SEND_COMMANDs	210
AI←input→O←output→	210
?AUTO_SETUP	210
AUTO_SETUP	210
CI←input→O←output→.....	210
CL←L#→I←I#→O←O#→	210
?EXT_AUD	210
?FAN_ALARM.....	211
?FAN_SPEED	211
?FG.....	211
?IFCONFIG.....	211
IFCONFIG.....	211
?INPUT	211
?MODEL	212
?OUTPUT	212
?POWER_ALARM	212
REBOOT.....	212
?TEMP	212
?TEMP_ALARM.....	212
VI←input→O←output→.....	212
Standard Input/Output Boards: SEND_COMMANDs	213
Variables for I# and O#	213
Standard Input SEND_COMMANDs	213
?AUDIN_DIGITAL.....	213
AUDIN_DIGITAL	213
?AUDIN_ENCODING	213
?AUDIN_NAME.....	213
AUDIN_NAME.....	213
?AUDIN_STATUS.....	214
?VIDIN_CABLE_CONNECTED.....	214
?VIDIN_EDID	214
VIDIN_EDID	214
?VIDIN_EDID_DATA	214
VIDIN_EDID_DATA	214
?VIDIN_FORMAT	215
?VIDIN_HDCP	215
VIDIN_HDCP.....	215
?HDCPSTATUS	215
?VIDIN_NAME	215
VIDIN_NAME	215
Standard Output SEND_COMMANDs	216
?AUDOUT_ENCODING	216

?AUDOUT_NAME	216
AUDOUT_NAME	216
?VIDIN_PREF_EDID	216
VIDIN_PREF_EDID	216
?VIDIN_RES_REF	216
VIDIN_RES_REF	216
?VIDIN_STATUS	216
?VIDOUT_ASPECT_RATIO	217
VIDOUT_ASPECT_RATIO	217
?VIDOUT_BLANK	217
VIDOUT_BLANK	217
VIDOUT_BLOCKED	217
?VIDOUT_BRIGHTNESS	217
VIDOUT_BRIGHTNESS	217
?VIDOUT_CABLE_CONNECTED	217
?VIDOUT_CONTRAST	218
VIDOUT_CONTRAST	218
?VIDOUT_EDID_DATA	218
?VIDOUT_EDID_LIST	218
?VIDOUT_FORMAT	218
?VIDOUT_FREEZE	218
VIDOUT_FREEZE	218
?VIDOUT_HDCP_STATUS	218
?VIDOUT_MUTE	219
VIDOUT_MUTE	219
?VIDOUT_NAME	219
VIDOUT_NAME	219
?VIDOUT_OSD	219
VIDOUT_OSD	219
?VIDOUT_OSD_COLOR	219
VIDOUT_OSD_COLOR	220
?VIDOUT_OSD_POS	220
VIDOUT_OSD_POS	220
?VIDOUT_RES_REF	220
VIDOUT_RES_REF	220
?VIDOUT_SCALE	220
VIDOUT_SCALE	220
?VIDOUT_SLEEP	221
VIDOUT_SLEEP	221
?VIDOUT_SLEEP_DELAY	221
VIDOUT_SLEEP_DELAY	221
?VIDOUT_STATUS	221
?VIDOUT_TESTPAT	221
VIDOUT_TESTPAT	221
DXLink Input and Output Boards: SEND_COMMANDS	222
?AUDIN_FORMAT	222
AUDIN_FORMAT	222
?AUDIN_FORMAT_AUTO	222
AUDIN_FORMAT_AUTO	222
?AUDOUT_FORMAT	222
AUDOUT_FORMAT	222
?DXLINKIN_LINK_STATUS	222
?DXLINKOUT_LINK_STATUS	222
?DXLINKIN_QUALITY	223
?DXLINKOUT_QUALITY	223
?DXLINKIN_QUALITY_ALARM	223
?DXLINKOUT_QUALITY_ALARM	223
?VIDIN_AUTO_SELECT	223
VIDIN_AUTO_SELECT	223
?VIDIN_HSHIFT	223
VIDIN_HSHIFT	223
?VIDIN_PHASE	224
VIDIN_PHASE	224
?VIDIN_VSHIFT	224
VIDIN_VSHIFT	224
Audio Switching Boards: SEND_COMMANDS	225
?AUDIN_COMPRESSION	225
AUDIN_COMPRESSION	225
?AUDIN_COMPRESSION_ATTACK	225

AUDIN_COMPRESSION_ATTACK	225
?AUDIN_COMPRESSION_RATIO	225
AUDIN_COMPRESSION_RATIO	225
?AUDIN_COMPRESSION_RELEASE	226
AUDIN_COMPRESSION_RELEASE	226
?AUDIN_COMPRESSION_THRESH	226
AUDIN_COMPRESSION_THRESH	226
?AUDIN_GAIN	226
AUDIN_GAIN	226
?AUDIN_STEREO	226
AUDIN_STEREO	226
Audio Output SEND_COMMANDs	227
?AUDOUT_EQ_CF	227
AUDOUT_EQ_CF	227
?AUDOUT_EQ_ENABLE	227
?AUDOUT_BALANCE	227
AUDOUT_BALANCE	227
?AUDOUT_DELAY	227
AUDOUT_DELAY	227
AUDOUT_EQ_ENABLE	228
?AUDOUT_EQ_FT	228
AUDOUT_EQ_FT	228
?AUDOUT_EQ_GAIN	228
AUDOUT_EQ_GAIN	228
?AUDOUT_EQ_MODE	228
AUDOUT_EQ_MODE	228
?AUDOUT_EQ_Q	229
AUDOUT_EQ_Q	229
?AUDOUT_MAXVOL	229
AUDOUT_MAXVOL	229
?AUDOUT_MINVOL	229
AUDOUT_MINVOL	229
?AUDOUT_MUTE	229
AUDOUT_MUTE	230
AUDOUT_RESET_EQ	230
?AUDOUT_STEREO	230
AUDOUT_STEREO	230
?AUDOUT_TESTTONE	230
AUDOUT_TESTTONE	230
?AUDOUT_TESTTONE_ENABLE	230
AUDOUT_TESTTONE_ENABLE	230
Audio Switching Board Down-mix SEND_COMMANDs	231
?down-mix_DOLBY_DRC	231
down-mix_DOLBY_DRC	231
?down-mix_SOURCE	231
down-mix_SOURCE	231
?AUDOUT_VOLUME	231
AUDOUT_VOLUME	231
?HDMIOUT_AUDIO	231
HDMIOUT_AUDIO	231
DXLink Endpoint SEND_COMMANDs	232
?ENDPOINT_TX_ICSLAN_PORT	232
ENDPOINT_TX_ICSLAN_PORT	232
?ENDPOINT_RX_ICSLAN_PORT	232
ENDPOINT_RX_ICSLAN_PORT	232
NetLinx NX Master Telnet Commands	232
AUTO LOCATE	
(ENABLE DISABLE STATUS)	232
DOT1X	
(ENABLE DISABLE STATUS)	232
MANAGE FIRMWARE	232
PROGRAM	
(ENABLE DISABLE STATUS)	232
PROGRAM INFO	233
REBOOT	233
Firmware Upgrade & Info for Network Admin	234

Overview	234
Preparation Checklist for Firmware Upgrade	234
Preparation Checklist:	234
Sending Firmware (*.KIT) Files to the Enova DGX	234
Master Upgrade	236
Enova DGX 100 Series Upgrade (Offline Upgrade)	236
Changing the Proxy Setting	237
Adding an Exception to the Proxy Settings	237
Checking Cache Settings in a Web Browser	238
Appendix A - Adding or Replacing Boards	239
Overview	239
Input and Output Boards	239
Expansion Boards	240
Procedure Overview	240
Items Required	240
Safety Recommendations for Laser Products	240
Adding or Replacing a Board	241
To remove and replace an Enova DGX board:.....	241
Board Troubleshooting	243
Problems with Board Power Up	243
Appendix B - Replacing Battery on CPU	244
Overview	244
Removing and Installing the CPU Battery	244
Items Required	244
Removing and Installing an DGX CPU Battery	244
Setting the CPU Clock.....	246
CPU Troubleshooting	246
Appendix C - DGX_SHELL Commands	247
Overview	247
Entering the DGX_SHELL Terminal Interface	247
Switching Between DGX_SHELL and BCS Interfaces	248
Product to Board Slot Correspondence	248
Basic DGX_SHELL Commands	249
?	249
help	249
help -a	249
help -v	249
help <cmd>	249
exit	249
announce.....	250
bcs.....	250
channel	250
clear	251
date	251
echo	251
history.....	251
ifconfig	251
log	251
logtail.....	251
manage	251
mxlog	252
ping	252
reboot	252
reset.....	253

sc.....	253
set.....	253
show.....	254
splash.....	254
su.....	254
switch.....	254
unset.....	254
version.....	254
Appendix D - Telnet Communication with DGX CPU	256
Overview.....	256
Enabling the Telnet Session	256
Enabling the Telnet session via NetLinx Studio:.....	256
Enabling the Telnet session via DGX_SHELL Commands.....	256
Using the Telnet Connection	256
Launching the Telnet Session	256
Telnet Default Communication	257
Setting the Telnet Connection to Start in BCS	257
Setting the Telnet Connection to Start in the DGX_SHELL	257
Confirming the Telnet Session Starting Environment	257
Disabling the Telnet Session	257
Via NetLinx Studio	257
Via DGX_SHELL Command	257
Confirming Telnet Session is Enabled/Disabled.....	258
Via NetLinx Studio	258
Via Serial Connection	258
Appendix E - Upgrading/Downgrading the System	259
Overview.....	259
Upgrade Sequence Overview.....	259
Upgrading a Solecis Digital Switcher	259
Upgrading the Control Panel.....	260
Removing Current CPU Board and Installing 100 Series CPU Board	261
Important Information for CPU Upgrade from 8/16/32/64 to 100 Series.....	261
Items Required	262
Removing and Replacing an DGX CPU board assembly:	262
Audio Switching Boards (ASB and ASB-DAN) - Rules for System Setup.....	263
Upgrading the Enclosure (Including Boards)	264
Adding Audio Switching Boards (ASB or ASB-DAN) to an Upgraded Enclosure.....	265
To enable default settings on the audio sub-system:	265
Upgrading DXLink Transmitter/Receiver Endpoints	265
To reset factory settings and enable the most recent EDIDs on a DXLink Fiber TX via Pushbutton ID:	266
Downgrade Sequence Overview	266
Downgrading DXLink Endpoint Firmware	267
Downgrading Enova DGX 100 Series Enclosures.....	267
Downgrading the Front Control Panel.....	267
Removing 100 Series CPU Board and Installing Enova DGX 8/16/32/64 CPU Board.....	267
Important Information for CPU Downgrade from 100 Series to 8/16/32/64.....	267
Items Required	267
To remove and replace an Enova DGX CPU board assembly:	268
Troubleshooting.....	269
Appendix F - DGX Configuration Software	270
Overview.....	270
PC System Requirements for DGX Configuration Software v1.0.6.....	270

Software Installation on PC and Enova DGX Connection	270
To install DGX Configuration Software:	270
DGX Configuration Software Setup	270
General Notes for Working with DGX Configuration Software	271
Scaler Mode View	272
Scaler Modes	272
Auto Mode	272
Bypass Mode	272
Manual (Override) Mode	272
Changing the Scaler Mode Settings	272
Maintain Aspect Ratio and Stretch to Fit	273
Scaler Override View	273
Get Current Timing, Apply, and Save Buttons	273
File Menu Options: Open File and Save to File	273
Retrieving EDID timings From a Destination Device	273
(A) Setting an EDID Timing That Was Read From The Detected Device	274
(B) Setting a Standard EDID Preset	275
(C) Setting a Custom Resolution With Optional Advanced Detailed Timing Settings	276
EDID Programmer View	276
EDID Overview	276
Digital Media Switchers and EDID	277
Determining the Need for EDID Re-programming	277
Determining if EDID Re-programming Is Necessary	277
Board Support for DVI and HDMI Signals - Changing the EDID Setting	277
DVI Boards	278
HDMI Boards	278
Options for Re-programming EDIDs	278
Reading and Saving EDID Data from a Destination Device	278
Reading and Saving EDID Data	278
Writing EDID Data to DGX DXLink, DVI, or HDMI Input Connector	279
To write EDID data to the EDID chip for an input connector:	279
Custom HDMI and DVI EDID Files for Handling Audio/Video Concerns	279
Files using 1080p (VIC 16) as the preferred and native video resolution:	279
Files using 720p (VIC 4) as the preferred and native video resolution:	279
Audio Troubleshooting	280
Checking for Support	280
Device Between HDMI Output Board and Monitor	280
Reading EDID Directly From Monitor And Applying Override Values To Output	280
HDCP Settings View	281
Enabling/Disabling HDCP Support For HDMI, 4K HDMI, or DVI Input	281
Terminal View	281
BCS Commands	281
Auxiliary BCS Commands	281
DGX_SHELL Commands	281
Sending a Command to the System	282
Saving the Current Data In The Terminal Window To a File	282
Appendix G - External Serial Controllers	283
Overview	283
External Serial Control Options	283
BCS Control	283
Third-Party Controllers	283

External Serial Control via USB Control Port	283
Attaching a PC To the USB (mini-B) Port and Establishing a Virtual COM Port.....	283
External Serial Control via DB-9 Control Port.....	286
PC Requirements for Serial Control.....	286
RS-232 Pin Diagram	286
Establishing External Serial Control Via the Control (DB-9 serial) Port	286
Serial Communication Settings	287
Terminal Emulation via NetLinx Studio	287
Appendix H - Supported Output Resolutions	288
ICSP Settable Output Resolutions.....	288
Digital Video Output Resolution Support	289

Enova DGX 100 Series - Overview

Applicability Notice

The information in this manual applies to the following Enova DGX 100 Series Digital Media Switcher enclosures, plus input, output, and expansion boards, which can be ordered to create custom systems. All of the boards listed in this section are compatible with the Enova DGX enclosures listed below:

Enova DGX 100 Series Digital Media Switchers - Enclosures				
Model	Part #	Rack Units	Configuration	Page #
DGX800-ENC	FG1061-08	4RU	8x8 Video and up to 16x16 Audio with Audio Switching Boards	page 35
DGX1600-ENC	FG1061-16	4RU	16x16 Video and up to 24x24 Audio with Audio Switching Boards	page 37
DGX3200-ENC	FG1061-32	6RU	32x32 Video and up to 40x40 Audio with Audio Switching Boards	page 39
DGX6400-ENC	FG1061-64	13RU	64x64 Video and up to 80x80 Audio with Audio Switching Boards	page 41

All Enova DGX Switchers ship with a standard front control panel. See the *Control Panel* section on page 67 for details.

DGX Digital Media Switchers & Standard Video Input and Output Boards

Enova DGX 100 Series Switchers currently support four standard Enova DGX input and output board types: HDMI, DVI, DXLink Twisted Pair, and DXLink Fiber Boards. Each board fills one of the standard I/O board slots and has four connectors. Within a system, a source device connected to any of the input boards can be routed to any destination device connected to any of the output boards (check the board chapters for important signal information when routing between board types).

If a system has empty input or output board slots (which are numbered for additional inputs and outputs), the slots can be used to expand the system. For information on adding or replacing boards, see "Appendix A – Adding or Replacing Boards" on page 239.

NOTE: Two types of audio expansion boards are also available (see the *Enova DGX Expansion Boards* section on page 27).

Enova DGX HDMI 4K60 Boards

Type	Part #	Model
4K60 HDMI Input	FG1061-542	DGX-I-HDMI-4K60
4K60 HDMI Output	FG1061-552	DGX-O-HDMI-4K60

Enova DGX HDMI Boards

Type	Part #	Model
HDMI Input	FG1058-540	DGX-I-HDMI
4K HDMI Input	FG1061-540	DGX-I-HDMI-4K
HDMI Output	FG1058-550	DGX-O-HDMI

Enova DGX DVI Boards

Type	Part #	Model
DVI Input	FG1058-600	DGX-I-DVI
DVI Output	FG1058-610	DGX-O-DVI

Enova DGX DXLink Twisted Pair Boards

Type	Part #	Model
DXLink Twisted Pair Input	FG1058-570	DGX-I-DXL
DXLink Twisted Pair Output	FG1058-580	DGX-O-DXL

NOTE: Enova DXLink Twisted Pair Boards must be used in conjunction with DXLink Twisted Pair Transmitters and Receivers or other AMX DXLink signal management solutions. For model numbers of compatible Transmitters and Receivers, see page 112. For system setup information, see page 116.

IMPORTANT: Before connecting a Solecis Digital Switcher to a DXLink Twisted Pair Input Board in an Enova DGX 100 Series Digital Media Switcher, both the Solecis unit and all DXLink Twisted Pair boards must be upgraded with the latest available firmware versions. Solecis units must be upgraded before connecting a unit to an upgraded input board.

Enova DGX DXLink Twisted Pair 4K Boards

Type	Part #	Model
DXLink Twisted Pair 4K Input	FG1061-570	DGX-I-DXL-4K
DXLink Twisted Pair 4K Output	FG1061-580	DGX-O-DXL-4K

NOTE: Enova DXLink Twisted Pair 4K Boards must be used in conjunction with DXLink Twisted Pair 4K Transmitters and Receivers or other AMX DXLink signal management solutions. For model numbers of compatible Transmitters and Receivers, see page 123. For system setup information, see page 127.

Enova DGX DXLink Fiber Boards

Type	Part #	Model
DXLink Multimode Fiber Input Board, Duplex	FG1058-622	DGX-I-DXF-MMD
DXLink Multimode Fiber Output Board, Duplex	FG1058-632	DGX-O-DXF-MMD
DXLink Single Mode Fiber Input Board, Duplex	FG1058-620	DGX-I-DXF-SMD
DXLink Single Mode Fiber Output Board, Duplex	FG1058-630	DGX-O-DXF-SMD
DXLink Multimode Fiber Input Board, Simplex	FG1058-623	DGX-I-DXF-MMS
DXLink Multimode Fiber Output Board, Simplex	FG1058-633	DGX-O-DXF-MMS
DXLink Single Mode Fiber Input Board, Simplex	FG1058-621	DGX-I-DXF-SMS
DXLink Single Mode Fiber Output Board, Simplex	FG1058-631	DGX-O-DXF-SMS

NOTE: Enova DXLink Fiber Boards must be used in conjunction with DXLink Fiber Transmitters and Receivers. For model numbers of compatible Transmitters and Receivers, see page 134. For system setup information, see page 139.

Input and Output Boards and Signal Types

A single enclosure can handle a combination of signals depending on the types of input and output boards.

Input and Output Boards and Supported Signals												
I/O Board Types	Signal Types	HDMI w/HDCP	HDMI w/out HDCP	DVI-D w/HDCP	DVI-D w/out HDCP	Embedded Audio	Embedded Audio from Audio Insert/Extract Board	Analog Video	Discrete Digital Audio	Analog Stereo Audio	3D Video	Deep Color
	Input: HDMI and 4K HDMI		•	•	•*	•*	•	•				•
Output: HDMI		•	•	•*	•*	•	•					•
Input: DVI		•	•	•	•	•**	•				•	•
Output: DVI		•	•	•	•	•**	•					•
Input and Output: DXLink Twisted Pair^		•	•	•	•	•	•	•***	•	•	•	•
Input and Output: DXLink Twisted Pair 4K^		•	•	•	•	•	•	•***	•	•	•	•
Input and Output: DXLink Fiber^^		•	•	•	•	•	•	•***	•	•	•	•

* HDMI Boards require a cable adapter to support single-link DVI signals.

** For a DVI Board to support embedded audio on an HDMI signal, the EDID must be updated.

*** Supported analog video signals include RGBHV, RGBS, RGsB, and Y/Pb/Pr in and RGBHV out.

^ Signals supported by DXLink Twisted Pair Boards depend on the type of DXLink Twisted Pair TXs and RXs used.

^^ Signals supported by DXLink Fiber Boards depend on the type of DXLink Fiber TXs and RXs used.

NOTE: The DXLink Twisted Pair Boards also support embedded power, NetLinx control, and Ethernet. The DXLink Fiber Boards also support NetLinx control and Ethernet (Duplex units provide this by default; Simplex units require additional setup).

All signals are automatically converted to the destination device's format, with DXLink Twisted Pair TXs and RXs used for transport of signals with DXLink Twisted Pair Boards and DXLink Fiber TXs and RXs used for transport of signals with DXLink Fiber Boards.

Input and Output Board Connectors

The connectors on the input and output boards are the attachment points for source and destination devices that connect to the system. Viewed from the rear of the enclosure, the input connectors (for attaching sources) are on the left, and the output connectors (for attaching destinations) are on the right, with the exception of the DGX 6400 enclosure which has inputs on top and outputs on bottom.

Input and output channel numbers correspond to the connectors and are located as follows:

- Enova DGX 800/1600 – on the vertical numbering plate (metal strip) between input and output connectors.
- Enova DGX 3200 – on the horizontal numbering plate (metal strip) directly above connectors.
- Enova DGX 6400 – on the vertical numbering plate (metal strip) between left and right input and left and right output connectors.

NOTE: For information on the board connectors on the expansion boards, see the chapter for the specific type of expansion board.

Connectors and Signal Types

Connector	Supported Signals
HDMI	<ul style="list-style-type: none"> • HDMI with or without HDCP or embedded digital audio • DVI-D (single link) with or without HDCP (adapter cable required)
DVI	<ul style="list-style-type: none"> • DVI-D (single link) with or without HDCP • HDMI with or without HDCP or embedded digital audio*
DXLink (RJ-45) (Signal support depends on the type of DXLink Twisted Pair 4K TXs and RXs used.)	<ul style="list-style-type: none"> • HDMI with or without HDCP or embedded digital audio • DVI with or without HDCP or embedded digital audio • Analog video input (RGBHV, RGBS, RGsB, Y/Pb/Pr) • Digital audio or analog stereo audio • Embedded power, NetLinx, and Ethernet
DXLink Fiber (LC Duplex) (Signal support depends on the type of DXLink Fiber TXs and RXs used.)	<ul style="list-style-type: none"> • HDMI with or without HDCP or embedded digital audio • DVI with or without HDCP or embedded digital audio • Analog video input (RGBHV, RGBS, RGsB, Y/Pb/Pr) • Digital audio or analog stereo audio • NetLinx and Ethernet (DXLink Fiber, Duplex models only)**

* For a DVI connector to support embedded audio on an HDMI signal, the EDID must be updated.

** For Simplex models – control can be provided if a supplemental independent network connection is used (see illustration on page 142).

Enova DGX Expansion Boards

Expansion boards work in conjunction with HDMI Boards, DVI Boards, DXLink Twisted Pair Boards, DXLink Fiber Boards to route audio with video and/or breakaway the audio (depending on the board). Enova DGX Switchers support three types of expansion boards:

- **Dante Audio Switching Boards (ASB-DAN)**
- **Audio Switching Boards (ASB)**
- **Audio Insert/Extract Board (AIE)**

If the expansion board slots in an enclosure are empty, the slots can be used for expansion boards to expand the functionality of the system.

The procedure for installing/replacing Audio Switching Boards is the same as for the standard input/output boards. The procedure for the Audio Insert/Extract Board (which needs to be set for insertion or extraction) starts on page 178.

NOTE: Enova DGX expansion boards do not work in standard input or output board slots. Likewise, standard input or output boards do not work in expansion board slots.

Audio Switching Board (ASB-DAN and ASB) Sets (page 164)

Type	Part #	Model
Audio Switching Board Set (one I/O pair) for DGX 800/1600	FG1061-716	DGX800/1600-ASB (ENOVA DGX 800/1600 AUD SWITCH BOARD KIT)
Audio Switching Board Set (one I/O pair) for DGX 3200	FG1061-732	DGX3200-ASB (ENOVA DGX 3200 AUD SWITCH BOARD KIT)
Audio Switching Board Set (two I/O pairs) for DGX 6400	FG1061-764	DGX6400-ASB (ENOVA DGX 6400 AUD SWITCH BOARD KIT)
Dante Audio Switching Board Set (one I/O pair) for DGX 800/1600/3200	FG1061-832	DGX3200-ASB-DAN (DANTE AUD SWITCH BOARD KIT)
Dante Audio Switching Board Set (two I/O pairs) for DGX 6400	FG1061-864	DGX6400-ASB-DAN (DANTE AUD SWITCH BOARD KIT)

NOTE: Audio Switching Boards will not operate unless the complete board set (one or two I/O pairs, depending on model) is installed.

Enova DGX Audio Insert/Extract Board (page 175)

Type	Part #	Model
Audio Insert/Extract	FG1058-705	DGX-AIE

Important Notes on Using Expansion Boards

- ASB-DAN, ASB, and AIE boards are not compatible with one another and cannot be used in the same system.
- ASB and AIE boards use terminal block connectors to bring auxiliary audio into the system and/or out of the system.
- ASB-DAN/ASB and AIE numbering overlays are provided, which can be applied to the I/O board numbering plate (see the relevant board chapter), which is across the top or down the center (depending on the enclosure).

Integrated NetLinx NX Master Functionality

The integrated NetLinx NX Master in Enova DGX enclosures is a NetLinx NX Controller.

Network Connection

The default IP address for the ICS LAN network is **198.18.0.1** with a subnet mask of **255.255.0.0**.

The LAN 100/1000 (public network) and ICS LAN (private network) subnets must not overlap. If the LAN 100/1000 port is configured such that its address space overlaps with the ICS LAN network, the ICS LAN network will be disabled.

The DGX communicates with the 5002 device (and any endpoint in Auto-setup) via ICS LAN. Since those devices have fixed static IP addresses on the ICS LAN network, you cannot change the 198.18 subnet information on the DGX platform of processors. You can only change the Host name and DHCP server settings.

Additionally, if connecting the Enova DGXs LAN 100/1000 port to an NX-x200 NX Integrated Controller's ICS LAN port, you MUST change the NX Master's ICS LAN port settings (via the SET ICSLAN telnet command) to choose a different subnet than the default 198.18.x.x or else the Enova DGXs 5002 switcher device (and any endpoint in Auto-setup) will not come online.

DHCP Server

The ICS LAN port has a built-in DHCP server. This DHCP server is enabled by default and will serve IP addresses to any connected devices set to DHCP mode. The DHCP server can be disabled from a Telnet session with the integrated NetLinx NX Master with the command: SET ICSLAN. The DHCP address range is fixed.

- The server will provide addresses in the range 198.18.0.2 through 198.18.63.254.
- Devices using static IP addresses on the ICS LAN network should be set within the reserved static IP address range of 198.18.64.1 through 198.18.127.254.
- Do not use addresses in the range 198.18.128.1 through 198.18.129.254, as they are reserved for future upgrades.
- The server supports TX and RX (endpoint) Auto-setup with addresses in the range 198.18.130.1 through 198.18.135.254.

IMPORTANT: The ICS LAN port on the left of the CPU is for communication via Telnet of endpoint devices connected to the integrated Master in Auto-setup Mode. The ICS LAN allows the DGX to provide Private IP addresses to all connected endpoints while only consuming a single IP address on the Public LAN. However, that the ICS LAN port serves DHCP addresses to any connected device. If the ICS LAN is inadvertently connected to the Public LAN, devices also on the Public LAN may experience DHCP address conflicts.

Opening Public LAN and ICS LAN Sockets from Code

The integrated NetLinx NX Master opens sockets from NetLinx or Java code on whichever network has an IP subnet that matches the address provided in the command to open the socket. No other indications are provided for which network is in use, only whether the socket is successfully created.

Integrated NetLinx NX Master Features

The integrated NetLinx NX Master supports the following features:

- Automatic configuration of AMX devices via ICS LAN (private network)
- Link-local fallback in DHCP mode (IPv4 only)
- Wired 802.1x (security for protected networks)
- IPv6 network addressing
- ID Pushbutton
- Case sensitive file system
- Differences in DEFINE_PROGRAM execution
- USB Program port driver for Windows 7 and Windows 8
- Telnet Commands for the Enova DGX 100 Series NetLinx NX Master

Automatic Configuration of AMX Devices via ICS LAN

When an ICS LAN capable endpoint device (e.g., a DXLink Twisted Pair Transmitter connected to a DXLink Twisted Pair Input Board) is initially connected, the integrated Master sends ICS LAN messages to the device and conducts automatic configuration (auto-setup), after which the device reboots.

If the Master is set to serve DHCP addresses and the device is set to DHCP addressing mode, a stable connection is assured. Since these are the factory default settings for the devices, automatic configuration is the expected behavior for all new equipment.

Even after being automatically configured for a Master in this manner, if the device is disconnected and reconnected to a different Master, its old configuration will be forgotten and it will establish a new configuration with the new Master to which it has been connected. Once connected, the device can also be configured for a different connection mode if desired.

Device auto-setup status is discoverable via NetLinX Studio such that Auto-setup device IP addresses reside in the 198.18.x.x space where the first "x" represents either 130 (input side) or 134 (output side) and the second "x" represents an individual port number.

- Transmitter endpoints: 198.18.30.x (where x is the input channel)
- Receiver endpoints: 198.18.134.x (where x is the output channel)

Device numbering in NetLinX Studio places auto-setup devices on the input side in the range 45001 to 45999 and devices on the output side in the range 46001 to 46999.

Link-local Fallback in DHCP Mode (IPv4 Only)

When the integrated Master's public LAN IP addressing mode is set to DHCP, it will attempt to acquire an IPv4 address from a DHCP server for approximately one minute after boot. If the Master does not receive a valid DHCP address in that time (e.g. if a DHCP server is not found), it will fall back to an IPv4 address in the link-local range.

NOTE: *Link-local is not an operational mode for the Master; it is a temporary addressing scheme to permit access over the network so that IP settings can be modified. Do not commission the Master with a link-local IP address.*

The default link-local address is 169.254.x.y, where x and y are the least significant two octets of the MAC address. The Master will first verify that this address is not taken by another device on the network. If the address is taken, the Master uses a standard algorithm to find an available IP address in the link-local range.

When the Master is using a link-local IP address, the status light will blink once per second. If the Master's network settings remain in DHCP mode, it will attempt to acquire a DHCP address every five minutes until successful. After each failed attempt to acquire a DHCP address, the Master will execute the link-local algorithm and may not fall back to the same link-local IP address.

Wired 802.1x Support

The integrated NetLinX NX Master supports 802.1X, an IEEE Standard for Port-based Network Access Control (PNAC). The Master acts as a supplicant (client device) to an 802.1X enabled network and presents customer-provided X.509 certificates to be allowed access to protected networks.

Support for IPv6 Network Addressing

The integrated NetLinX NX Master fully supports IPv6 network addressing. If the LAN 100/1000 port is connected to an IPv6 capable network, it will self-select an appropriate IPv6 address based on the discovered address settings of the network to which it is attached.

The Master simultaneously supports IPv4 network addressing. This means any Master may have more than one valid IP address: one IPv4 and one or more IPv6 addresses. When opening sockets from NetLinX or Java code, no unique command is available to indicate that you are providing an IPv4 or IPv6 network address. As long as the provided IP address is a valid IPv4 or IPv6 address, the Master will utilize the correct addressing protocol automatically.

ID Pushbutton

The ID Pushbutton functions performed depend on when and for how long the ID Pushbutton is pressed and held. The integrated Master includes ID Pushbutton functionality for selecting a static or DHCP address, performing a factory default reset, and restoring the factory firmware image (for instructions, see page 44).

Case Sensitive File System

All file names on the integrated Master are case sensitive. This includes all user files created or used within NetLinX or Java code. If your legacy code generates an error when accessing a file, it is likely due to inconsistent use of case in the filename.

IMPORTANT: If you have legacy code that uses files, verify that every reference to each file is consistent with regard to case.

USB Program Port Driver

The integrated NetLinX NX Master is configurable for communication with a PC over the switcher's USB Program port. On Enova DGX 100 Series Switchers, the USB Program port includes pre-loaded drivers for use with a PC running either Windows 7 or Windows 8.

The integrated NetLinX NX Master utilizes a USB (mini-AB) Program port for configuration and programming via a connected PC. The required USB driver installs automatically with NetLinX Studio v4.0 or later.

Because a PC COM port can only be used for a single process at a time, having a terminal window open using the COM port assigned to that USB connection will prevent any other communication to the Master over that same USB connection, including refreshing the OnLine Tree and transferring files. We recommend using the front control panel to discover the IP address of the Master, modifying the IP address via the USB Program port if necessary, and then connecting over Ethernet to the new IP address. For additional information, see page 58.

Differences in DEFINE_PROGRAM Execution

Due to differences in the underlying architecture of the integrated Master, changing variables in the DEFINE_PROGRAM section of code can negatively impact program performance.

If you have legacy NetLinX code that does change a variable in this section, timing differences very likely will cause your code to run slower and appear less responsive on the Master.

Enova DGX NetLinX and Control Specifications

Enova DGX NetLinX and Control Specifications	
Integrated Controller	
LAN 100/1000 Port (RJ-45)	<ul style="list-style-type: none"> NetLinX on-board Master is an NX Class Controller TCP/IP uplink port (LAN 10/100/1000) Supports up to 64-port unmanaged 10/100 Ethernet Switch (cascaded architecture actual throughput dependent on loading) Static IP or DHCP/DNS, SSL, Auto-negotiating, Auto MDI/MDI-X Crossover Supports IPv4 and IPv6 networks Supports HTTP, HTTPS, Telnet, FTP, TCP/IP, UDP/IP, CIP, SMTP Built-in Web server Includes support for DXLink™ devices
ICS LAN Port (RJ-45)	Auto-setup and connection for control of endpoint devices
Processor	1600 MIPS
Memory	SDRAM 512 MB / NVRAM 1 MB / Flash 8 GB
Program Port (USB)	USB Mini-AB connector - used for NetLinX Studio control
ID Pushbutton	Sets IP mode or revert to default configuration and firmware
Configuration DIP Switch	2-position PRD Mode Setup
Enclosure Control	
Control Port (DB-9)	<ul style="list-style-type: none"> Bidirectional RS-232 Baud rates of 9600, 19200, 38400, 57600, 115200 (default)
Control Port (USB)	USB Mini-B connector
AxLink Port (captive wire)	<ul style="list-style-type: none"> 4-position 3.5 mm screw terminal provides data and power to external AxLink control devices 3A Max Load
USB (HID) keyboard & Mouse	<p>Use the Enova DGX Digital Media Switcher in conjunction with DXLink Transmitters and Receivers (twisted pair and/or fiber), connect a DXLink TX to a PC and a DXLink RX to a keyboard and mouse, the system then emulates commands from the receiver back to the PC. The Solecis SDX-510M functions as a DXLink Transmitter in this scenario.</p> <p>For a list of HID devices which have been tested and found to be working well with the latest firmware, please view the document, "DXLink HID keyboard and Mouse Supported Devices" at www.amx.com on the product page for your DXLink Fiber Receiver or DXLink Twisted Pair Receiver.</p>

- **Enova DGX 6400:** Worst case per port throughput is 7 Mbps. Best case is 100 Mbps when used with 64 DXLink Transmitters and 64 DXLink Receivers.
- **Enova DGX 3200:** Worst case per port throughput is 10 Mbps. Best case is 100 Mbps when used with 32 DXLink Transmitters and 32 DXLink Receivers.
- **Enova DGX 1600:** Worst case per port throughput is 10 Mbps. Best case is 100 Mbps when used with 16 DXLink Transmitters and 16 DXLink Receivers.
- **Enova DGX 800:** Worst case per port throughput is 10 Mbps. Best case is 100 Mbps when used with 8 DXLink Transmitters and 8 DXLink Receivers.

For individual board information and specifications, see the specific board chapter in this manual.

Configuration Information and Control Options

Switching Configuration Information

The configuration file stored on the CPU contains routing and control information for the AMX Enova Routing System.

NOTE: *The configuration file is automatically generated by the system based on its hardware – input and output boards, expansion boards, front control panel, CPU, etc. If boards are added during runtime, they are immediately added to the system's configuration.*

From the factory, the configuration normally contains three virtual matrices (VMs) for switching signals:

- **VM 0** = default (System Configuration interface - controlled via **Switch Mode: A/V**)
- **VM 1** = video signals (System Configuration interface - controlled via **Switch Mode: Video**)
- **VM 2** = audio signals (System Configuration interface - controlled via **Switch Mode: Audio**)

Embedded Audio Signals

Embedded audio signals switch with the video channels.

- Through the use of **Audio Switching Boards** or **Dante Audio Switching Boards** and the System Configuration interface or ICSP commands, switched audio can be digitally processed (e.g., gain, volume, balance) and switched onto another digital signal, becoming embedded audio on that signal. For more information about Digital Signal Processing (DSP) options, see page 150 for Dante Audio Switching Boards or see page 164 for Audio Switching Boards,
- Through the use of the **Audio Insert/Extract Board**, embedded audio can be extracted and external audio matrix switches can be executed (using a separately purchased audio matrix switcher like the Precis DSP) and then reinserted post-switch on the output side. For more information, see the AIE Board chapter on page 175.

Available Levels (Virtual Matrices)

Enova DGX 100 Series systems support three levels for BCS control purposes (below). NetLinX code and ICSP Commands require the use of the values: ALL, VIDEO, and AUDIO for the corresponding switch levels.

- **L0 (All)** – comprises all available crosspoints for digital video with embedded audio (the standard matrix)
- **L1 (Video)** – comprises all available crosspoints for digital video with embedded audio (the standard matrix)
- **L2 (Audio)** – comprises the embedded audio on the standard matrix, plus auxiliary audio from the Audio Switching Boards

NOTE: *The standard matrix corresponds to the basic switcher size: 8x8, 16x16, 32x32, or 64x64.*

Audio Switching Boards

When Audio Switching Boards (ASB or ASB-DAN) are in the system, the Enova DGX 100 Series supports audio breakaway on VM 2 (via the Audio Switch Mode on the System Configuration interface). The system can route the embedded audio from any digital video input to any digital video output. Additionally, audio can be routed via the ASB connectors on VM 2 to/from any of digital video inputs/outputs (the default is for the ASB audio to take precedence), as well as from Audio Switching Board to Audio Switching Board.

NOTE: *If Audio Switching Boards are not in the system, any commands sent to Audio Switch Mode (VM2) shall be NACKed and no state change will be applied.*

Board Configuration Information

The System Configuration Interface can be used for configuring HDMI, DVI, DXLink Twisted Pair, and DXLink Fiber Boards. This interface can be used to set the Scaler mode, the aspect ratio, and custom resolutions as well as re-program the EDID on input boards (see page 184).

IMPORTANT: Because signals routed through HDMI, DVI, DXLink Twisted Pair, DXLink Twisted Pair 4K, and DXLink Fiber Boards in an Enova DGX Switcher normally produce a quality image, you will not need to use the System Configuration interface unless the installation has special scaling, EDID, or HDCP requirements.

Control Options

NOTE: *For an overview of audio control options and a list of where those options are located within this manual, see the Installation and Setup section on page 44.*

Integrated NetLinX NX Central Control Processor

- **System Configuration interface** – This interface is the Enova DGX 100 Series Switchers' installation setup tool. It is used during system setup to manage your system's network, security, and system needs, as well as configure its inputs and outputs while executing switches. Note that some devices run on a secured file-system. As such, file-system operations (e.g., Load and Save operations) may not be supported by the devices default capabilities and may require downloading a file manager application.
- **SEND_COMMANDs** – The Enova DGX Switcher can be controlled using AMX SEND_COMMANDs. ICSP is the primary protocol for all system level messaging on integrated NetLinX NX Central Control Processors and is a peer-to-peer protocol used for both Master-to-Master and Master-to-device communications. For details, see page 211.

Control Panel

The Control Panel is standard on all Enova DGX Switchers (see page 67).

AMX Control Devices

The Enova DGX Switcher is compatible with a number of AMX control devices via Native NetLinX communication. For control programming information, see the chapter on ICSP commands on page 204 and the manual for the specific AMX control device.

BCS (Basic Control Structure) Protocol

The Enova DGX Switcher can be controlled with an external serial controller using BCS protocol. For information on BCS commands, see the *BCS (Basic Control Structure) Protocol Programming Guide* at www.amx.com.

- Serial control (sends and receives ASCII characters)
- Use the Control (RS-232 serial) port or use the USB Control port (as a virtual COM port); both are located on the CPU
- Commands can be entered into a terminal emulation program on a PC

Third-Party Controllers

A third-party controller can be attached to an Enova DGX Switcher via the RS-232 serial port. If using a third-party controller, see the controller documentation for operating instructions.

Enova DGX 100 Series and Enova DGX 8/16/32/64: Differences

The Enova DGX 100 Series has incorporated a number of technological advancements which resulted in changes that may be of interest to users of previous Enova DGX products. In order to assist these users, we have included the table below which captures some of the main system differences (highlighted cells represent changes that may affect programming code in existing systems).

Enova DGX 100 Series and Enova DGX 8/16/32/64 Differences		
	Enova DGX 8/16/32/64 Series	Enova DGX 100 Series
NetLinx Programming and Switcher Control		
Switcher Control (NetLinx ICSP) CHANGE	Can be sent to Port 2 or 3 CIxOyT (default A/V switch) CI<level>IxOyT (where <level>=0,1)	Must be sent to Port 1 (see page 217)
Switcher Control (NetLinx ICSP) STATUS	Can be sent to Port 2 or 3 SIxT SOyT	Must be sent to Port 1 (see page 217)
Switcher Control (NetLinx ICSP) DISCONNECT	Can be sent to Port 2 or 3 DIxT DOyT	Must be sent to Port 1. Uses 0 to disconnect - outputs ONLY (see page 217).
Serial (COM1) port USB (COM2) port	9600 baud, defaults to bcs (USB uses APBridge driver)	15200 baud, defaults to <DGX_SHELL> (see page 256).
Switcher Control (Serial)	Standard bcs commands	Standard bcs commands
Switcher Control (Web Control page) http://Master_IP_address	Master Configuration Manager Device 5002 / IP Control / XBar Controller	System Configuration interface Switcher / Switching or Configuration pages
Switcher Control (Telnet Interface)	BCS Tunnel (telnet to Master on port 15000) Supports basic bcs commands only	Telnet interface supports DGX_SHELL (default) and bcs commands (see page 256)
Local Presets	Local presets configurable via XNConnect	Does not support Local Presets
File system	Case insensitive	Case sensitive (more secure)
DEFINE_PROGRAM execution	Standard NetLinx execution	Possible timing differences (depends on program variables)
PRD mode	Settable via DIP switch on CPU board inside enclosure	Settable via DIP switch on CPU faceplate
Device Binding, Addressing, and Network Options		
Binding devices to the DGX Master	Traditional binding only (defaults to NDP)	<ul style="list-style-type: none"> Defaults to Auto-setup automatic binding of each device on the Private LAN (page 28) Traditional binding supported if Auto-setup is disabled in the System Configuration interface Status page
Device Addressing	Device name given via NDP or specified by user	<ul style="list-style-type: none"> In Auto-setup, endpoints are given an address per I/O channel (see page 28) With Auto-setup disabled, traditional device address rules apply
Network addressing	<ul style="list-style-type: none"> The DGX Master and each endpoint device consumes an IP address on the Public LAN Endpoint ICSLAN ports pass Public IP 	<ul style="list-style-type: none"> In Auto-setup, the DGX Master consumes a single Public IP address but all endpoints are given predefined Private LAN addresses (see page 28) With Auto-setup disabled, each endpoint gets a Public IP address Endpoint ICS LAN ports ONLY pass Public IP The Master and switcher always have Private LAN addresses: DGX Master: 198.18.0.1 DGX Switcher: 198.18.128.1 <p>WARNING: The master Public IP must NEVER use a 198.18.x.x subnet. Doing so will prevent the 5002 device from coming online.</p>
Telnet to Endpoints	Telnet to any point on the Public LAN as long as the PC is on the Public LAN	In Auto-setup, can ONLY telnet to endpoints when connected directly to the endpoint's ICS LAN port so that your PC receives an IP address on the Private LAN
Internet Protocol Versions and Network Security	IPv4 only	<ul style="list-style-type: none"> IPv4 and IPv6 Wired 802.1x security for protected networks
Compatibility and Hardware Support		
System Compatibility	Please refer to the document: Enova DGX Input/Output board and Endpoint Compatibility Instructions.	Requires kit v3.0.10 or later for new 100 Series feature support. Older I/O cards added to a new system must be upgraded.
I/O Board Hardware Support	Supports Enova DGX HDMI, DVI, DXLink Twisted Pair, DXLink Fiber Boards, and compatible Epica DGX SC Optical Boards. NOTE: Does not support DXLink Twisted Pair 4K Boards or 4K HDMI Boards.	Supports all Enova DGX I/O boards. NOTE: Does not support Epica DGX SC Optical Boards.

Enova DGX 100 Series and Enova DGX 8/16/32/64 Differences		
Audio and EDID Functionality		
EDID Read/Write Support	Use DGX Configuration Software EDID Programmer tab	Use System Configuration interface to change/save/load EDID. Changes can be made to either Video or Audio EDID or a Custom file loaded
Audio Expansion Boards NOTE: <i>Only one type of Expansion Board can be used in a given enclosure.</i>	Audio Insert/Extract (AIE) Boards Only	<ul style="list-style-type: none"> Audio Insert/Extract Boards (AIE) Audio Switching Boards (ASB) NOTE: <i>ASB must be installed <u>as a pair</u>.</i>
Audio Insert/Extract/Routing	AIE - DIP settings tie insertion/extraction to I/O channels. No audio breakaway routing	<ul style="list-style-type: none"> AIE - DIP settings tie insertion/extraction to I/O channels. ASB and ASB-DAN - Independent I/O channels for audio switching, breakaway, and down-mix. NOTE: <i>Switched audio also supports DSP functionality. Outputs utilizing ASB audio must be set to SWITCHED audio.</i>
down-mixing	Not Supported	Audio Switching Boards support one down-mix channel (the last audio input) which down-mixes any input channel and can be routed to any output
Upgrades, Firmware Resets, and Default Restoration		
Web Upgrade Status	Web Control Interface link to status page http://Master_IP_Address/web/upgrade/systemUpgradeStatus.xml	System Configuration interface System/Devices page, select the Switcher Update Status button
Failed Upgrade Recovery	Rolls back to previous kit version	Completes the upgrade to attempted kit version and identifies any mismatch in I/O cards that failed to update. This is shown in the OnLine Tree, the System Configuration interface, and <code>DGX_SHELL> show</code> .
Factory Firmware Image Reset Switcher	N/A	<code>DGX_SHELL> manage firmware</code> then select "F" for Factory
Factory Firmware Image Reset Master and AxLink Controller	N/A	ID Pushbutton on Master or Telnet to Master and type: <code>manage firmware</code> then select the device to reset (0 or 5001)
Restore system defaults	BCS command (<code>~def!</code>) NOTE: <i>only resets MCPU</i>	<code>DGX_SHELL</code> command (<code>reset factory</code>) <ul style="list-style-type: none"> resets whole system
System Components		
RJ-45 ports	<ul style="list-style-type: none"> Left: ENC & ENC Right: Public LAN 	<ul style="list-style-type: none"> Left: ICSLAN (Private LAN - DHCP Server) Right: Public LAN
External MicroSD Card	Contains system configuration, presets, event logs, SRM file.	<ul style="list-style-type: none"> Contains no files or data Only for file transfer to/from Internal SD Card
Internal MicroSD Card	N/A	Contains sys configuration, event logs, SRM file, current/previous/factory firmware, EDID Library
ID Button	N/A	<ul style="list-style-type: none"> Switch between DHCP and Static - 10 sec hold while running Factory Reset (Master) - 10 sec hold on power up Factory Firmware Reset (Master) - 20 sec hold on power up
Integrated AxLink Control	N/A	AxLink port for control of AMX AxLink devices
Control Panel	Basic control panel functions only.	Displays Integrated Master info and provides basic audio support (for embedded audio only)

System Diagnostic Options

The two system diagnostic options for the Enova DGX 100 Series are the Status page in the System Configuration interface and `DGX_SHELL` commands.

System Configuration Interface - Status Page

The Status page in the System Configuration interface (Switcher/Status) displays status for the power supplies, fans, CPU, I/O boards, and expansion boards (see page 141). For complete information, see the *WebConsole & Programming Guide - NetLinx NX Central Controllers* at www.amx.com.

DGX_SHELL Commands

The Enova DGX 100 Series supports a number of shell (command-line interpreter) commands for a variety of functions, both basic and advanced (see "Appendix C" on page 273).

InstaGate Pro Technology

InstaGate Pro Technology eliminates latency (time required for authentication) in the switcher for HDCP negotiations with the displays in a system. The latency is typically experienced when HDCP authenticates HDMI source and destination devices every time a new switching combination between a source device and display occurs. With InstaGate Pro Technology, when a source requires HDCP encrypted content, the inputs and compliant downstream devices are automatically authenticated – it just works. Key limitations on source devices are also eliminated by allowing them to see only a single sink key from the HDMI Input Board's input connection.

NOTE: *Some destination devices have a longer lag time than others between receiving a signal and displaying that signal. Although InstaGate Pro significantly reduces the latency associated with HDCP authentication, it cannot reduce the inherent lag time of a device as it syncs up to the newly switched video image.*

DGX 800

Front Panel

The front panel of DGX 800 Enclosures features an LCD screen, Control Panel, Input and Output keys and Power Indicator LED (FIG. 1):



FIG. 1 DGX 800 - Front Panel Components

Power Indicator LED Behavior

- **Green** – both power supplies are powered on
- **Red** – one of the power supplies is not receiving power or has failed
- **Off** – neither power supply is receiving power

Rear Panel

Enova DGX 800 enclosures have four horizontal I/O board slots - two slots each for input and output boards with four connectors each, allowing for a maximum configuration of 8x8. FIG. 2 shows the rear panel of an DGX 800 enclosure, fully loaded for 8x8 switching:

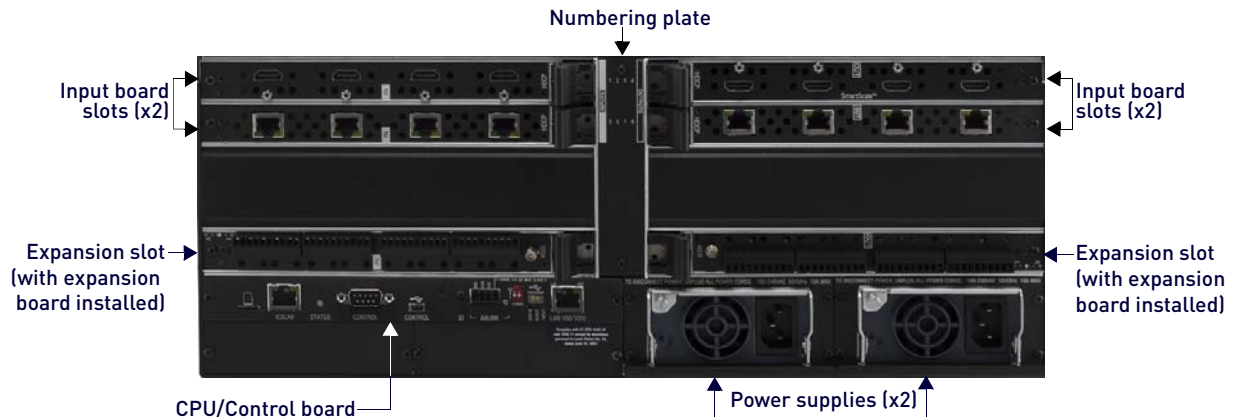

FIG. 2 DGX 800 - Rear Panel Components

NOTE: If the enclosure has an empty input or output board slot (which is numbered for an additional board), it can be used to expand the system, to a maximum of 2 input and 2 output boards. The blank plates under the input and output board slots cannot be removed.

Power Supplies (x2)

The ENC 800 has two power supply units. Each of the power supply units has a power receptacle that will accept all major international standard power sources. (US power cords are included with all enclosures shipped within the US.) Maximum power specifications are provided on the power supply receptacles.



- AC: Green light indicates power is good
- DC: Green light indicates power is good
- Amber light indicates temperature is above normal
- Red light indicates that the power supply is in a fault state

FIG. 3 ENC 800 Power Supply

NOTE: For information on applying power, see page 63.

Specifications

DGX 800 Specifications	
Parameter	Value
Approvals	UL 60950-1, CSA 60950-1, IEC 60950-1, IEC 62368-1, CE EN 60950-1, CE EN 55022 Class A, CE EN 55024, FCC CFR Title 47 Part 15 Subpart B Class A, ICES-003 Class A, RoHS, WEEE
AC Power per Supply	100-240 +/-10% VAC single phase, 50/60 Hz
Power Capacity (max.)	977 Watts (110 VAC and 230 VAC)
Power Consumption (max.)	562 Watts, fully loaded DXLink Power enclosure with redundancy
Power Consumption (typical)	139 Watts, fully loaded 4K60 HDMI enclosure with redundancy
Thermal Dissipation Full Capacity (max.)	3334 BTU/hr.
Thermal Dissipation (max.)	1917 BTU/hr, fully loaded DXLink Power enclosure with redundancy
Thermal Dissipation (typical)	475 BTU/hr, fully loaded 4K60 HDMI enclosure with redundancy
Power Factor Correction (PFC)	Supported, complies with EN60555-2 and EN61000-3-2
Operational Temperature	32° F to 104° F (0° C to 40° C)
Storage Temperature	-22° F to 158° F (-30° C to 70° C)
Operational Humidity	5% to 85% RH (non-condensing)
Storage Humidity	0 to 90% RH (non-condensing)
MTBF	640,715 hrs
Dimensions	<ul style="list-style-type: none"> • 15 in. (38.1 cm) depth; 16 in. (40.64 cm) depth with extractors • 19 in. (48.26 cm) width including integral rack mounting ears • 6.84 in. (17.37 cm) height (4 RU)
Weight	Approximately 35 lb. (15.9 kg) per loaded enclosure
Shipping Weight	Approximately 45 lb. (20.4 kg) per loaded enclosure
Per Channel Aggregate Data Rate (max.)	26 Gbps
Noise Level	<52.5 dBA @ 1 m (typical @ 25° C)
Airflow	Forced air (inlet on side; exhaust on side)
Compatible DXLink™ Twisted Pair Transmitters and Receivers	<ul style="list-style-type: none"> • DXLink Multi-Format Transmitter Modules • DXLink Multi-Format Wallplate Transmitters • DXLink Multi-Format Decor Style Wallplate Transmitters (US) • DXLink HDMI Receiver Modules
Compatible DXLink™ Twisted Pair 4K Transmitters and Receivers	<ul style="list-style-type: none"> • DXLink 4K HDMI Decor Style Wallplate Transmitters (US) • DXLink HDMI 4K Receiver Modules
Compatible DXLink™ Fiber Transmitters and Receivers	<ul style="list-style-type: none"> • DXLink Multi-Format MM Fiber TX, Duplex/Simplex • DXLink Multi-Format SM Fiber TX, Duplex/Simplex • DXLink HDMI MM Fiber RX, Duplex/Simplex • DXLink HDMI SM Fiber RX, Duplex/Simplex
Compatible Solecis Digital Switchers	<ul style="list-style-type: none"> • Solecis 4x1 HDMI Digital Switcher with DXLink Output • Solecis 5x1 Multi-Format Digital Switcher with DXLink Output • Solecis 8x1 HDMI Digital Switcher with DXLink Output
Compatible Solecis 4K Digital Switchers	<ul style="list-style-type: none"> • Solecis 4x1 4K HDMI Digital Switcher with DXLink Output • Solecis 5x1 4K Multi-Format Digital Switcher with DXLink Output

DGX 1600

Front Panel

The front panel of DGX 1600 Enclosures features an LCD screen, Control Panel, Input and Output keys and Power Indicator LED (FIG. 4):

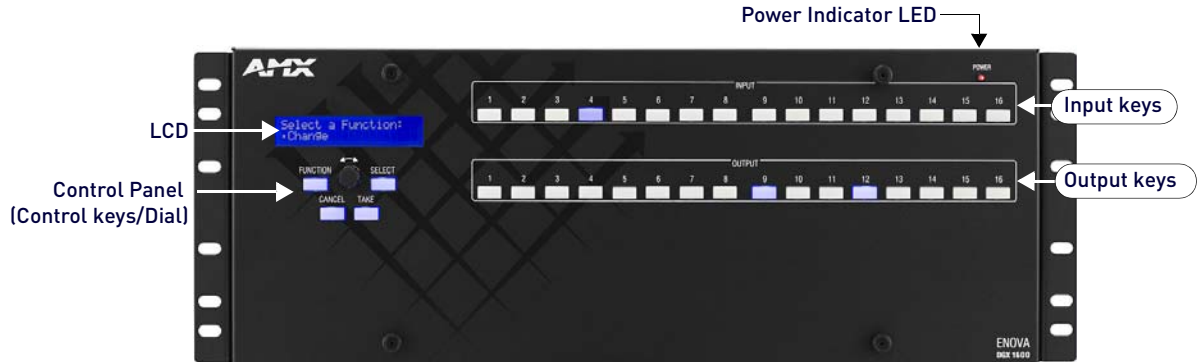

FIG. 4 DGX 1600 - Front Panel Components

Power Indicator LED Behavior

- **Green** – both power supplies are powered on
- **Red** – one of the power supplies is not receiving power or has failed
- **Off** – neither power supply is receiving power

Rear Panel

Enova DGX 1600 enclosures have eight horizontal I/O board slots (four slots each for input and output boards with four connectors each), allowing for a maximum configuration of 16x16. FIG. 5 shows the rear panel of an DGX 1600 enclosure, fully loaded for 16x16 switching:

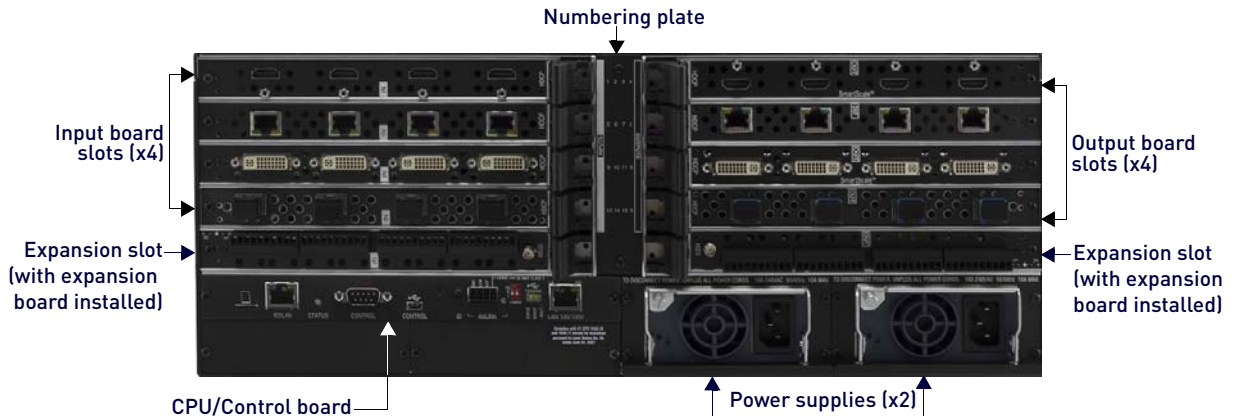

FIG. 5 DGX 1600 - Rear Panel Components

Power Supplies (x2)

The ENC 1600 has two power supply units. Each of the power supply units has a power receptacle that will accept all major international standard power sources. (US power cords are included with all enclosures shipped within the US.) Maximum power specifications are provided on the power supply receptacles.



FIG. 6 ENC 1600 Power Supply

- AC: Green light indicates power is good
- DC: Green light indicates power is good
- Amber light indicates temperature is above normal
- Red light indicates that the power supply is in a fault state

NOTE: For information on applying power, see page 63.

Specifications

DGX 1600 Specifications	
Parameter	Value
Approvals	UL 60950-1, CSA 60950-1, IEC 60950-1, IEC 62368-1, CE EN 60950-1, CE EN 55022 Class A, CE EN 55024, FCC CFR Title 47 Part 15 Subpart B Class A, ICES-003 Class A, RoHS, WEEE
AC Power per Supply	100-240 +/-10% VAC single phase, 50/60 Hz
Power Capacity (max.)	977 Watts (110 VAC and 230 VAC)
Power Consumption (max.)	953 Watts, fully loaded DXLink Power enclosure with redundancy
Power Consumption (typical)	182 Watts, fully loaded 4K60 HDMI enclosure with redundancy
Thermal Dissipation Full Capacity (max.)	3334 BTU/hr.
Thermal Dissipation (max.)	3251 BTU/hr, fully loaded DXLink Power enclosure with redundancy
Thermal Dissipation (typical)	621 BTU/hr, fully loaded 4K60 HDMI enclosure with redundancy
Power Factor Correction (PFC)	Supported, complies with EN60555-2 and EN61000-3-2
Operational Temperature	32° F to 104° F (0° C to 40° C)
Storage Temperature	-22° F to 158° F (-30° C to 70° C)
Operational Humidity	5% to 85% RH (non-condensing)
Storage Humidity	0 to 90% RH (non-condensing)
MTBF	627,105 hrs
Dimensions	<ul style="list-style-type: none"> 15 in. (38.1 cm) depth; 16 in. (40.64 cm) depth with extractors 19 in. (48.26 cm) width including integral rack mounting ears 6.84 in. (17.37 cm) height (4 RU)
Weight	Approximately 55 lb. (24.95 kg) per loaded enclosure
Shipping Weight	Approximately 65 lb. (29.5 kg) per loaded enclosure
Per Channel Aggregate Data Rate (max.)	26 Gbps
Noise Level	<52.5 dBA @ 1 m (typical @ 25° C)
Airflow	Forced air (inlet on side; exhaust on side)
Compatible DXLink™ Twisted Pair Transmitters and Receivers	<ul style="list-style-type: none"> DXLink Multi-Format Transmitter Modules DXLink Multi-Format Wallplate Transmitters DXLink Multi-Format Decor Style Wallplate Transmitter (US) DXLink HDMI Receiver Modules
Compatible DXLink™ Twisted Pair 4K Transmitters and Receivers	<ul style="list-style-type: none"> DXLink 4K HDMI Decor Style Wallplate Transmitters (US) DXLink HDMI 4K Receiver Modules
Compatible DXLink™ Fiber Transmitters and Receivers	<ul style="list-style-type: none"> DXLink Multi-Format MM Fiber TX, Duplex/Simplex DXLink Multi-Format SM Fiber TX, Duplex/Simplex DXLink HDMI MM Fiber RX, Duplex/Simplex DXLink HDMI SM Fiber RX, Duplex/Simplex
Compatible Solecis Digital Switchers	<ul style="list-style-type: none"> Solecis 4x1 HDMI Digital Switcher with DXLink Output Solecis 5x1 Multi-Format Digital Switcher with DXLink Output Solecis 8x1 HDMI Digital Switcher with DXLink Output
Compatible Solecis 4K Digital Switchers	<ul style="list-style-type: none"> Solecis 4x1 4K HDMI Digital Switcher with DXLink Output Solecis 5x1 4K Multi-Format Digital Switcher with DXLink Output

DGX 3200

Front Panel

The front panel of DGX 3200 Enclosures features an LCD screen, Control Panel, Input and Output keys and Power Indicator LED (FIG. 7):



FIG. 7 DGX 3200 - Front Panel Components

Power Indicator LED Behavior

- Green – both power supplies are powered on
- Red – one of the power supplies is not receiving power or has failed
- Off – neither power supply is receiving power

Rear Panel

FIG. 8 shows the rear panel of an DGX 3200 enclosure, fully loaded for 32x32 switching.:

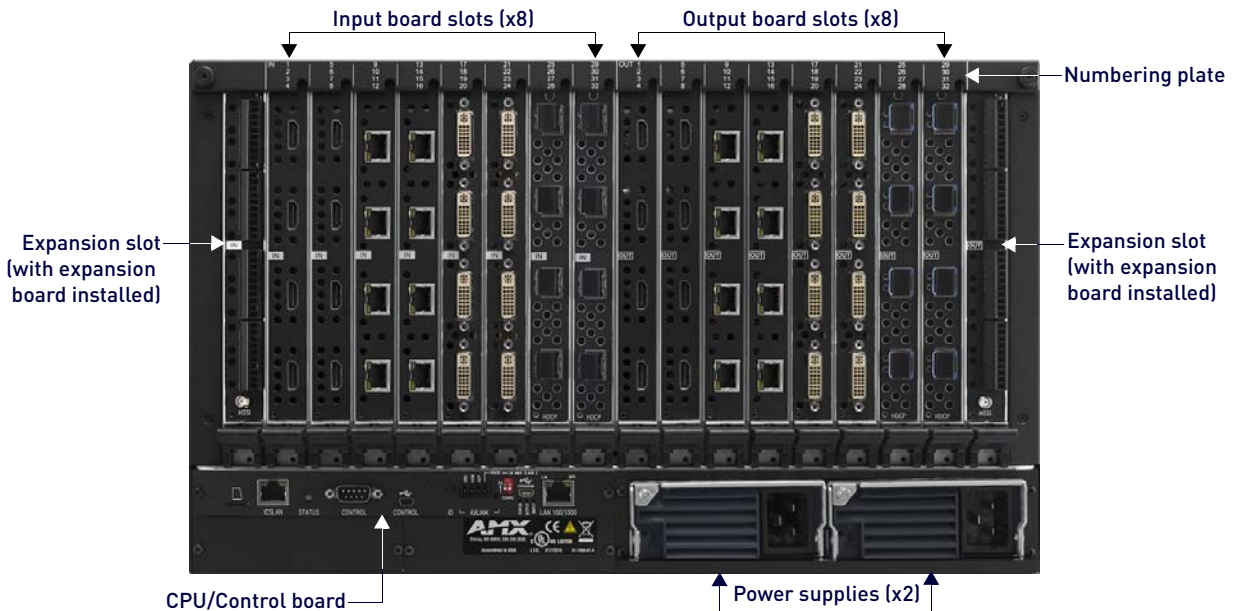

FIG. 8 DGX 3200 - Rear Panel Components

Power Supplies (x2)

The ENC 3200 has two power supply units. Each of the power supply units has a power receptacle that will accept all major international standard power sources. (US power cords are included with all enclosures shipped within the US.) Maximum power specifications are provided on the power supply receptacles.



FIG. 9 ENC 3200 Power Supply

- AC: Green light indicates power is good
- DC: Green light indicates power is good
- Amber light indicates temperature is above normal
- Red light indicates that the power supply is in a fault state

NOTE: For information on applying power, see page 63.

Specifications

DGX 3200 Specifications	
Parameter	Value
Approvals	UL 60950-1, CSA 60950-1, IEC 60950-1, IEC 62368-1, CE EN 60950-1, CE EN 55022 Class A, CE EN 55024, FCC CFR Title 47 Part 15 Subpart B Class A, ICES-003 Class A, RoHS, WEEE
AC Power per Supply	100-240 +/-10% VAC single phase, 50/60 Hz
Power Capacity (max.)	<ul style="list-style-type: none"> 1320 Watts, with redundancy @ 110 VAC 1730 Watts, with redundancy @ 230 VAC 2640 Watts, without redundancy @ 110 VAC 3459 Watts, without redundancy @ 230 VAC
Power Consumption (max.)	1813 Watts*, fully loaded DXLink Power enclosure without redundancy
Power Consumption (typical)	308 Watts, fully loaded 4K60 HDMI enclosure with redundancy
Thermal Dissipation Full Capacity (max.)	<ul style="list-style-type: none"> 4508 BTU/hr, with redundancy @ 110 VAC 5908 BTU/hr, with redundancy @ 230 VAC 9016 BTU/hr, without redundancy @ 110 VAC 11813 BTU/hr, without redundancy @ 230 VAC
Thermal Dissipation (max.)	6322 BTU/hr*, fully loaded DXLink Power enclosure without redundancy
Thermal Dissipation (typical)	1051 BTU/hr, fully loaded 4K60 HDMI enclosure with redundancy
Power Factor Correction (PFC)	Supported, complies with EN60555-2 and EN61000-3-2
Operational Temperature	32° F to 104° F (0° C to 40° C)
Storage Temperature	-22° F to 158° F (-30° C to 70° C)
Operational Humidity	5% to 85% RH (non-condensing)
Storage Humidity	0 to 90% RH (non-condensing)
MTBF	439,457 hrs
Dimensions	<ul style="list-style-type: none"> 20.08 in. (51 cm) depth; 21.08 in. (53.54 cm) with extractors 19 in. (48.26 cm) width including integral rack mounting ears 10.45 in. (26.54 cm) height (6 RU)
Weight	Approximately 73 lb. (33.1 kg) per loaded enclosure
Shipping Weight	Approximately 83 lb. (37.6 kg) per loaded enclosure
Per Channel Aggregate Data Rate (max.)	26 Gbps
Noise Level	<52.5 dBA @ 1 m (typical @ 25° C)
Airflow	Forced air (inlet on side; exhaust on side)
Compatible DXLink™ Twisted Pair Transmitters and Receivers	<ul style="list-style-type: none"> DXLink Multi-Format Transmitter Modules DXLink Multi-Format Wallplate Transmitters DXLink Multi-Format Decor Style Wallplate Transmitter (US) DXLink HDMI Receiver Modules
Compatible DXLink™ Twisted Pair 4K Transmitters and Receivers	<ul style="list-style-type: none"> DXLink 4K HDMI Decor Style Wallplate Transmitters (US) DXLink HDMI 4K Receiver Modules
Compatible DXLink™ Fiber Transmitters and Receivers	<ul style="list-style-type: none"> DXLink Multi-Format MM Fiber TX, Duplex/Simplex DXLink Multi-Format SM Fiber TX, Duplex/Simplex DXLink HDMI MM Fiber RX, Duplex/Simplex DXLink HDMI SM Fiber RX, Duplex/Simplex
Compatible Solecis Digital Switchers	<ul style="list-style-type: none"> Solecis 4x1 HDMI Digital Switcher with DXLink Output Solecis 5x1 Multi-Format Digital Switcher with DXLink Output Solecis 8x1 HDMI Digital Switcher with DXLink Output
Compatible Solecis 4K Digital Switchers	<ul style="list-style-type: none"> Solecis 4x1 4K HDMI Digital Switcher with DXLink Output Solecis 5x1 4K Multi-Format Digital Switcher with DXLink Output

DGX 6400

Front Panel

The front panel of DGX 6400 Enclosures features an LCD screen, Control Panel, Input and Output keys and Power Indicator LED (FIG. 10):

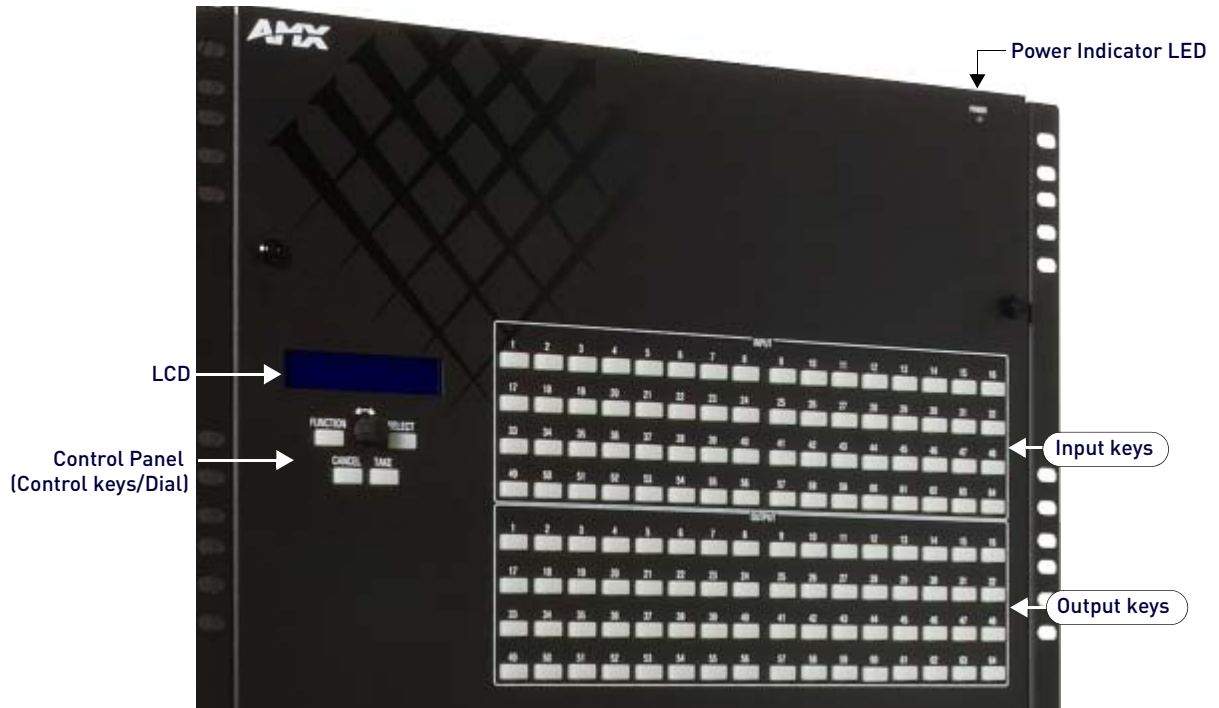

FIG. 10 DGX 6400 - Front Panel Components

Power Indicator LED Behavior

- **Green** – all four power supplies are powered on
- **Constant Red** – one of the power supplies is not receiving power or has failed
- **Flashing Red** – two (or three) of the power supplies are not receiving power or have failed
- **Flashing Green** – the system's input/output boards are being upgraded (the LED's response to power functions supersedes the upgrade function).
- **Off** – none of the power supplies is receiving power

NOTE: *If two or more power supplies are not receiving power, the CPU and the control panel will continue to operate. However, input and output boards will become inoperable and the system will not send or receive signals until at least three power supplies resume functional status.*

Rear Panel

Enova DGX 6400 enclosures have 32 horizontal I/O board slots (16 slots each for input and output boards with four connectors each), allowing for a maximum configuration of 64x64. FIG. 11 shows the rear panel of an DGX 6400 enclosure, fully loaded for 64x64 switching.:

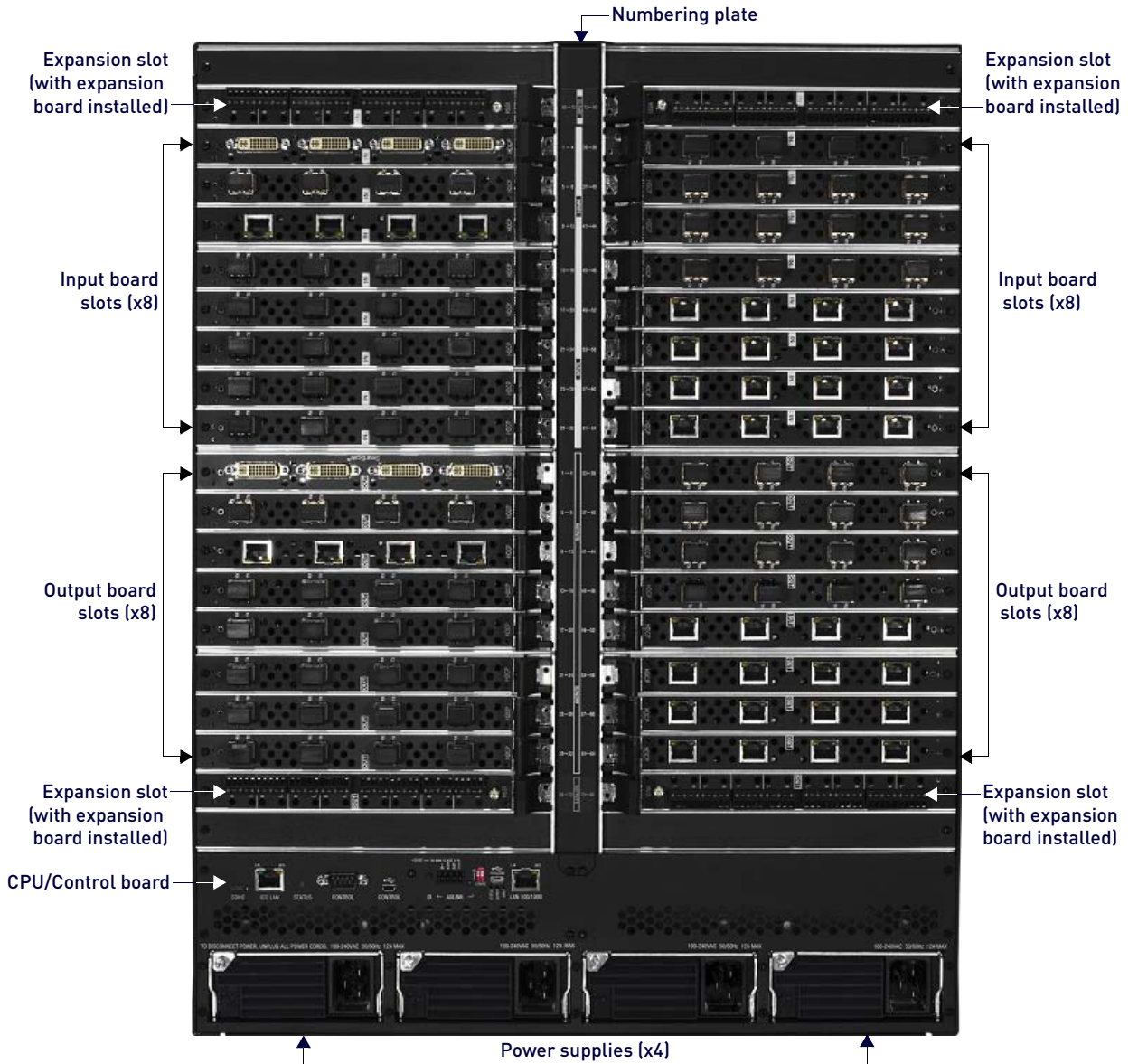

FIG. 11 DGX 6400 - Rear Panel Components

Power Supplies (x4)

The ENC 6400 has four power supply units. Each of the power supply units has a power receptacle that will accept all major international standard power sources. (US power cords are included with all enclosures shipped within the US.) Maximum power specifications are provided on the power supply receptacles.



FIG. 12 ENC 6400 Power Supply

- AC: Green light indicates power is good
- DC: Green light indicates power is good
- Amber light indicates temperature is above normal
- Red light indicates that the power supply is in a fault state

NOTE: For information on applying power, see page 63.

Specifications

DGX 6400 Specifications	
Parameter	Value
Approvals	UL 60950-1, CSA 60950-1, IEC 60950-1, IEC 62368-1, CE EN 60950-1, CE EN 55022 Class A, CE EN 55024, FCC CFR Title 47 Part 15 Subpart B Class A, ICES-003 Class A, RoHS, WEEE
AC Power per Supply	100-240 +/-10% VAC single phase, 50/60 Hz
Power Capacity (max.)	<ul style="list-style-type: none"> 3960 Watts, @ 110 VAC 5189 Watts, @ 230 VAC
Power Consumption (max.)	3522 Watts, fully loaded DXLink Power enclosure with redundancy
Power Consumption (typical)	510 Watts, fully loaded 4K60 HDMI enclosure with redundancy
Thermal Dissipation Full Capacity (max.)	<ul style="list-style-type: none"> 13524 BTU/hr, @ 110 VAC 17721 BTU/hr, @ 230 VAC
Thermal Dissipation (max.)	12017 BTU/hr, fully loaded DXLink Power enclosure
Thermal Dissipation (typical)	1741 BTU/hr, fully loaded 4K60 HDMI enclosure
Power Factor Correction (PFC)	Supported, complies with EN60555-2 and EN61000-3-2
Operational Temperature	32° F to 104° F (0° C to 40° C)
Storage Temperature	-22° F to 158° F (-30° C to 70° C)
Operational Humidity	5% to 85% RH (non-condensing)
Storage Humidity	0 to 90% RH (non-condensing)
MTBF	179,636 hrs
Dimensions	<ul style="list-style-type: none"> 19.99 in. (50.78 cm) depth; 21.14 in. (53.70 cm) with extractors 18.96 in. (48.15 cm) width with rack mounting ears 22.72 in. (57.71 cm) height (13 RU)
Weight	Approximately 150 lb. (68.0 kg) per loaded enclosure
Shipping Weight	Approximately 257 lb. (116.6 kg) per loaded enclosure
Per Channel Aggregate Data Rate (max.)	26 Gbps
Noise Level	<50.1 dBA @ 1 m (typical @ 25° C)
Airflow	Forced air (inlet on side; exhaust on side)
Compatible DXLink™ Twisted Pair Transmitters and Receivers	<ul style="list-style-type: none"> DXLink Multi-Format Transmitter Modules DXLink Multi-Format Wallplate Transmitters DXLink Multi-Format Decor Style Wallplate Transmitter (US) DXLink HDMI Receiver Modules
Compatible DXLink™ Twisted Pair 4K Transmitters and Receivers	<ul style="list-style-type: none"> DXLink 4K HDMI Decor Style Wallplate Transmitters (US) DXLink HDMI 4K Receiver Modules
Compatible DXLink™ Fiber Transmitters and Receivers	<ul style="list-style-type: none"> DXLink Multi-Format MM Fiber TX, Duplex/Simplex DXLink Multi-Format SM Fiber TX, Duplex/Simplex DXLink HDMI MM Fiber RX, Duplex/Simplex DXLink HDMI SM Fiber RX, Duplex/Simplex
Compatible Solecis Digital Switchers	<ul style="list-style-type: none"> Solecis 4x1 HDMI Digital Switcher with DXLink Output Solecis 5x1 Multi-Format Digital Switcher with DXLink Output Solecis 8x1 HDMI Digital Switcher with DXLink Output
Compatible Solecis 4K Digital Switchers	<ul style="list-style-type: none"> Solecis 4x1 4K HDMI Digital Switcher with DXLink Output Solecis 5x1 4K Multi-Format Digital Switcher with DXLink Output

Installation and Setup

DGX Enclosure MAC Address / Serial Number

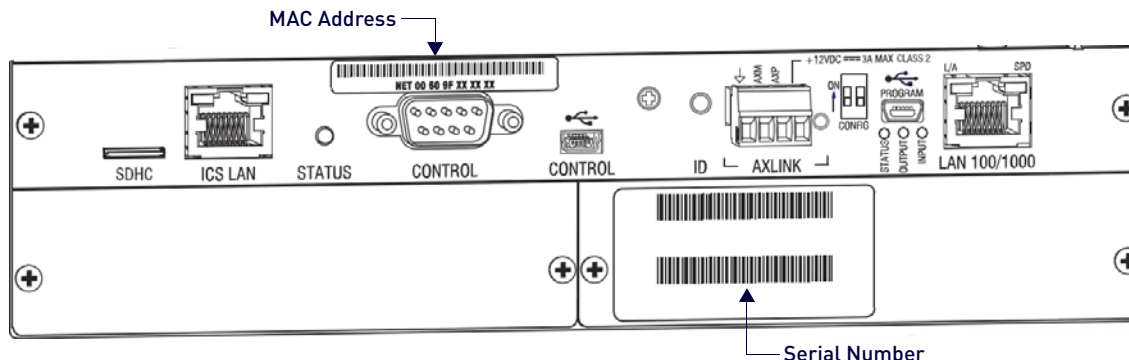

FIG. 13 DGX Enclosures rear view (CPU/Control board) - MAC Address and Serial Number decals

- The MAC address for the system is located directly above the Control (DB-9 serial) port on the CPU.
- The serial number is normally located on the rear of the enclosure on the left.

NOTE: Before installation, record the serial number for the enclosure (and for each module and/or wallplate as applicable) for future reference.

DXLink Fiber Boards

IMPORTANT: No user serviceable parts are included inside Enova DGX Switchers; service should only be done by qualified personnel.

IMPORTANT: If the Enova DGX Switcher contains Enova DGX DXLink Fiber Boards, be sure to read all of the safety information for laser products in this chapter and in the DXLink Fiber Boards chapter.

Safety Recommendations for Laser Products

WARNING: DXLink Fiber units use laser transceivers, which are Class 1 Eye Safe per IEC 60825-1/CDRH requirements. While the Class 1 category indicates that the invisible laser used is safe, always avoid direct eye exposure when using any optical fiber products (see the OSHA directive on page 135).

CAUTION: Use of controls or adjustments or performance of procedures other than those specified herein may result in hazardous radiation exposure.

Exercise caution when installing Enova DGX DXLink Fiber products to avoid direct eye exposure to invisible laser radiation. Follow the recommendations below whenever installing or working with fiber products.

- Be sure to apply the power only after all the fiber connections are made and no fiber ends are exposed.
- Do not remove dust plugs from fiber connectors or the dust caps from the fiber cables until establishing connections; avoid direct eye exposure.
- Make sure all cables, including fiber cables, are correctly connected and/or terminated.
- Before you unplug a fiber cable on an input board, disconnect the power on the transmitter that is connected to the input.
- Before you unplug a fiber cable on an output board, disconnect the switch for that output connector.

General Hazard Precautions

IMPORTANT: DXLink twisted pair cable runs for DXLink equipment shall only be run within a common building. "Common building" is defined as: Where the walls of the structure(s) are physically connected and the structure(s) share a single ground reference.

Elevated Operating Temperature

The maximum rated ambient temperature for the Enova DGX Switcher is 104° F (40° C).

All equipment should be installed in an environment compatible with the manufacturer's maximum rated ambient temperature. In a closed or multi-unit rack assembly, the operating ambient temperature of the rack environment may be greater than the ambient room temperature.

Airflow Restriction

Enova DGX Switchers are designed to adequately dissipate the heat they produce under normal operating conditions; however, this design is defeated if high heat producing equipment is placed directly above or below an enclosure.

CAUTION: To prevent overheating, avoid placing high heat producing equipment directly above or below the enclosure. The system requires a minimum of one empty rack unit above and below (three empty rack units are recommended). Verify that the openings on the top and sides of the enclosure are not blocked and do not have restricted air flow.

Mechanical (Rack) Loading

When installing equipment in a rack, distribute the weight to avoid uneven mechanical loading. Note that fully loaded, the Enova DGX 800 weighs approximately 35 pounds (15.9 kg), the Enova DGX 1600 weighs approximately 55 pounds (24.95 kg), the Enova DGX 3200 weighs approximately 73 pounds (33.1 kg), and the Enova DGX 6400 weighs approximately 150 pounds (68.0 kg).

Circuit Overloading

When connecting the equipment to the supply circuits, be aware of the effect that overloading the circuits might have on over-current protection and supply wiring.

Reliable Earthing (Grounding)

Reliable earthing of rack-mounted equipment should be maintained. If not using a direct connection to the branch circuit (e.g., plugging into a power strip), pay particular attention to supply connections.

CAUTION: We strongly recommend attaching all of the power cords to a surge protector and/or an AC line conditioner. After powering up the enclosure, apply power to the source and destination devices.

Site Recommendations

Environment

- Choose a clean, dust free, (preferably) air-conditioned location.
- Avoid areas with direct sunlight, heat sources, or high levels of EMI (Electromagnetic Interference).

Chassis Accessibility

Make sure the front and rear panels of the enclosure are accessible, so that you can monitor the Power indicator LED on the front and the other LED indicators on the rear. Leaving adequate clearance at the rear will also allow for easier cabling and service.

Power

Attach all power cords to a surge protector (20 A) and/or an AC line conditioner.

- The source's electrical outlet should be installed near the router, easily accessible, and properly grounded. Power should come from a building branch circuit. We strongly recommend using a dedicated line for the system's power. Use a minimum breaker current rating of 20 A for 110 V or 10 A for 230 V.
- To avoid an overload, note the power consumption rating of all equipment connected to the circuit breaker before applying power.

System Setup with Transmitters and Receivers

The following three sections cover system setup options for Enova DGX boards and their compatible TXs and RXs. The following general statements apply to all three sections:

- In each section's table where "Any input board" or "Any output board" is shown, check in the specific board's chapter to determine whether or not a transmitter or receiver is required.
- The transmitters and receivers mentioned in each section can be used as a standalone pair (end-to-end solution). For additional information, see the applicable manual for the modules/units.

CAUTION: If you plan to connect switching systems via their DXLink ports, be sure to read the information on page 119.

Options for System Setup with DXLink Twisted Pair

The following table contains the options in an Enova DGX Switcher for using DXLink Twisted Pair Input and Output Boards in conjunction with DXLink Twisted Pair Transmitters and Receivers:

System Setup Options - Enova DGX Boards with DXLink Modules/Wallplates			
DXLink Module/Wallplate	Enova DGX Input Board	Enova DGX Output Board	DXLink Module
Multi-Format TX Module →	DXLink Twisted Pair →	DXLink Twisted Pair →	HDMI RX Module
Multi-Format TX Module →	DXLink Twisted Pair →	Any output board →	Not applicable
Multi-Format Wallplate TX →	DXLink Twisted Pair →	DXLink Twisted Pair →	HDMI RX Module
Multi-Format Wallplate TX →	DXLink Twisted Pair →	Any output board →	Not applicable
Decor Wallplate TX →	DXLink Twisted Pair →	DXLink Twisted Pair →	HDMI RX Module
Decor Wallplate TX →	DXLink Twisted Pair →	Any output board →	Not applicable
Not Applicable	Any input board →	DXLink Twisted Pair →	HDMI RX Module

A typical system setup for a source and destination is illustrated on page 116 and shows an Enova DGX 1600 with DXLink Twisted Pair Boards used in conjunction with DXLink Twisted Pair Transmitters and Receivers.

NOTE: Solecis Digital Switchers have a DXLink Twisted Pair output port that optionally provides source point switching and distance transmission to an Enova DGX DXLink Twisted Pair Input Board for hub-style or campus-wide distribution.

IMPORTANT: Before connecting a Solecis Digital Switcher to a DXLink Twisted Pair Input Board in an Enova DGX 100 Series Digital Media Switcher, both the Solecis unit and all DXLink Twisted Pair boards must be upgraded with the latest available firmware versions. Solecis units must be upgraded before connecting a unit to an upgraded input board.

Options for System Setup with DXLink Twisted Pair 4K

The following table contains the options in an Enova DGX Switcher for using DXLink Twisted Pair 4K Input and Output Boards in conjunction with DXLink Twisted Pair 4K Transmitters and Receivers:

System Setup Options - Enova DGX Boards with DXLink Modules/Wallplates			
DXLink Wallplate	Enova DGX Input Board	Enova DGX Output Board	DXLink Module
HDMI 4K Decor Wallplate TX →	DXLink Twisted Pair →	DXLink Twisted Pair →	HDMI 4K RX Module
HDMI 4K Decor Wallplate TX →	DXLink Twisted Pair →	Any output board →	Not applicable
Not Applicable	Any input board →	DXLink Twisted Pair →	HDMI 4K RX Module

NOTE: Additional compatibility is available between DXLink Twisted Pair 4K and DXLink Twisted Pair equipment (see the DXLink Twisted Pair 4K Transmitters & Receivers Hardware Reference Manual).

Options for System Setup with DXLink Fiber

The following table contains the options for using DXLink Fiber Input and Output Boards in conjunction with DXLink Fiber TXs and RXs in an Enova DGX Digital Media Switcher. The input/output boards and TX/RX units can be either Duplex or Simplex, as long as the model types match (multimode to multimode and single mode to single mode).

IMPORTANT: Compatibility between hardware requires matching model types: multimode to multimode and single mode to single mode.

System Setup Options - Enova DGX Boards with DXLink Fiber			
DXLink Fiber TX	DXLink Fiber Input Board	DXLink Fiber Output Board	DXLink Fiber RX
Multi-Format MM Fiber TX →	Multimode Fiber →	Multimode Fiber →	HDMI MM Fiber RX
Multi-Format MM Fiber TX →	Multimode Fiber →	Single Mode Fiber →	HDMI SM Fiber RX
Multi-Format MM Fiber TX →	Multimode Fiber →	Any output board →	Not applicable
Multi-Format SM Fiber TX →	Single Mode Fiber →	Single Mode Fiber →	HDMI SM Fiber RX
Multi-Format SM Fiber TX →	Single Mode Fiber →	Multimode Fiber →	HDMI MM Fiber RX
Multi-Format SM Fiber TX →	Single Mode Fiber →	Any output board →	Not applicable
Not Applicable	Any input board →	Multimode Fiber →	HDMI MM Fiber RX
Not Applicable	Any input board →	Single Mode Fiber →	HDMI SM Fiber RX

NOTE: A typical system setup for a source and destination is illustrated on FIG. 53 on page 139.

Unpacking

Enova DGX Switchers are shipped with one enclosure per shipping box. The invoice is sent separately; a packing slip is attached to the outside of each box.

Each box contains the following items:

- Enova DGX 100 Series Digital Media Switcher
- US power cords (if shipped within the US): Two provided with the DGX 800/1600/3200, four are provided for the Enova DGX 6400
- Other enclosure related products as needed

NOTE: For orders comprising multiple enclosures, the shipping boxes are marked as "Chassis __ of __," where the first blank is the box number and the second blank is the total number of boxes in the shipment.

Unpacking Tips

- Before fully unpacking the enclosure, inspect the shipping box for any signs of damage. If a box is partially crushed or any sides have been broken open, notify the shipping agency immediately and contact your AMX representative (see the warranty at www.amx.com).
- Once unpacking is complete, closely check the physical condition of the enclosure.
- Collect all documentation.

NOTE: Please save the original shipping container and packing materials. AMX is not responsible for damage caused by insufficient packing during return shipment to the factory. Shipping boxes are available; contact your AMX representative for details.

Rack Installation and System Setup

Enova DGX 100 Series Switchers can be mounted in a standard EIA 19 in. (48.26 cm) rack.

Required Items

- Enclosure
- Enova DGX 6400 only – two rack mounting handles (provided)
- Standard EIA 19 in. (48.26 cm) rack
- Screwdriver
- Screws that fit your rack for mounting the enclosure
- Power cords (provided, if shipped within the US)
- Surge-protector – highly recommended

Optional Items

- PC or laptop computer with a null modem cable for communication with the enclosure via the RS-232 serial port

Recommendations

- Write the serial numbers (normally located on rear of enclosure) in an easily accessible location before installing the enclosure in a rack.
- Use earth-grounded power cords and equipment with an Enova DGX Switcher.
- Attach all power cords to a single surge protector and/or an AC line conditioner.
- Apply power to the Enova DGX Switcher before applying power to its source and destination devices.

Installation Procedure

A flow chart showing the installation sequence is in FIG. 14. The procedure below the chart provides general steps with references to detailed information found in later sections of the manual.

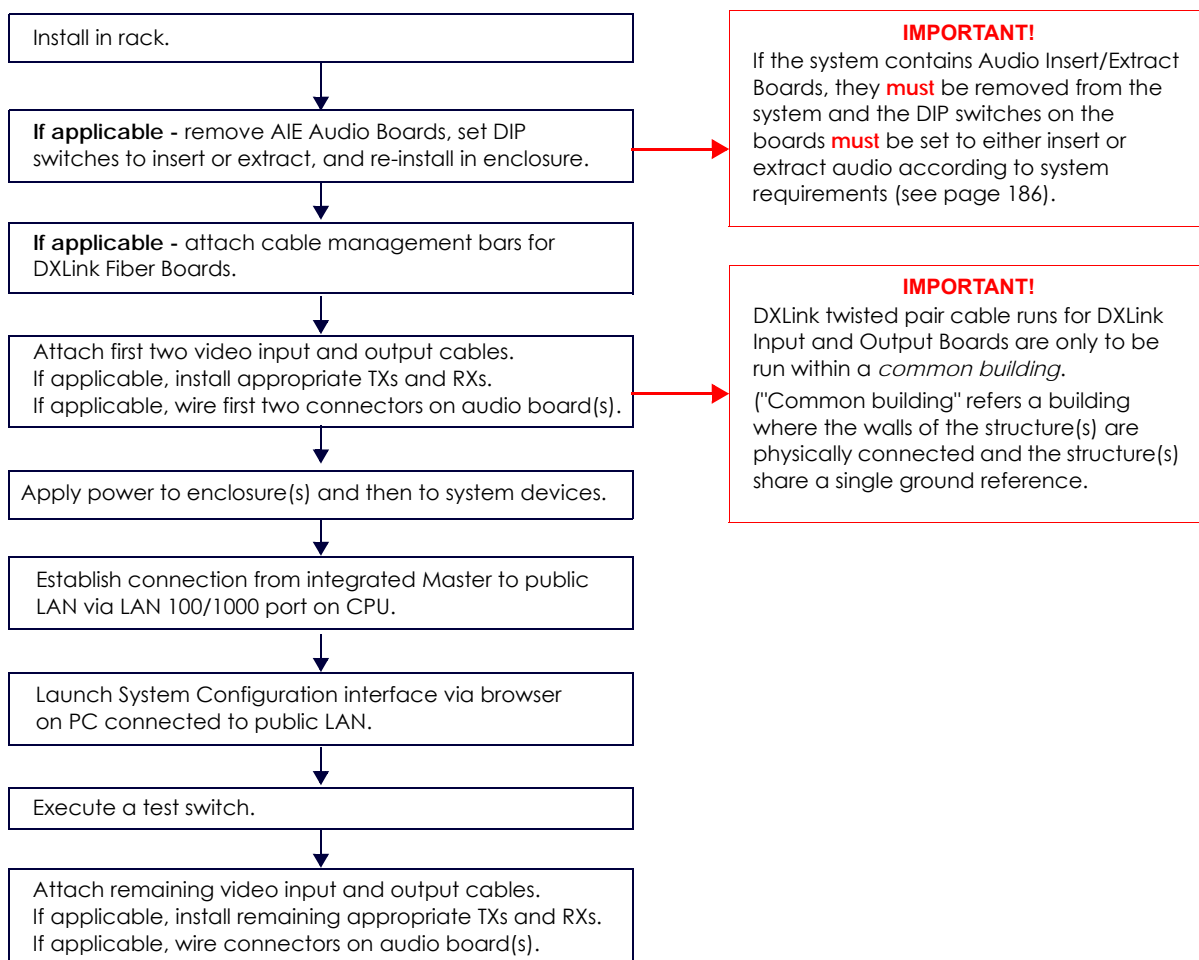

FIG. 14 Installation Procedure

CAUTION: To prevent overheating and airflow restriction, avoid placing high heat producing equipment directly above or below the enclosure. The system requires a minimum of one empty rack unit above and below (three empty rack units are recommended). Verify that the openings on the top and sides of the enclosure are not blocked and **do not** have restricted air flow.

Rack-Mounting Enova DGX 100 Series Enclosures

Rack-Mounting DGX 6400 Enclosures

The DGX 6400 Enclosure come with

CAUTION: The Enova DGX 6400 weighs approximately 150 lb (68 kg) for a fully loaded enclosure.

- Installation of the DGX 6400 requires a minimum of two people, we recommend using three people for lifting and positioning the enclosure.
 - Ensure all parties involved in lifting the shipping box are prepared and follow local requirements as necessary for the task (e.g., wearing proper lifting attire, number of lifters, etc).
1. While the shipping box containing the enclosure is still on the pallet, cut loose and remove the outer straps.
 2. Remove the cardboard tray from the top of the reusable shipping box. Note that the shipping box is mounted on wheels.
 3. Lift the shipping box off of the pallet.
 4. Unlock the four latches on the two sides of the shipping box.
 5. Lift the top of the shipping box straight up and over the Enova DGX 6400 and set aside.
 6. Attach the two provided Lifting Handles, using either the front or rear position as indicated in FIG. 15. Be sure to tighten down all four screws on both handles.

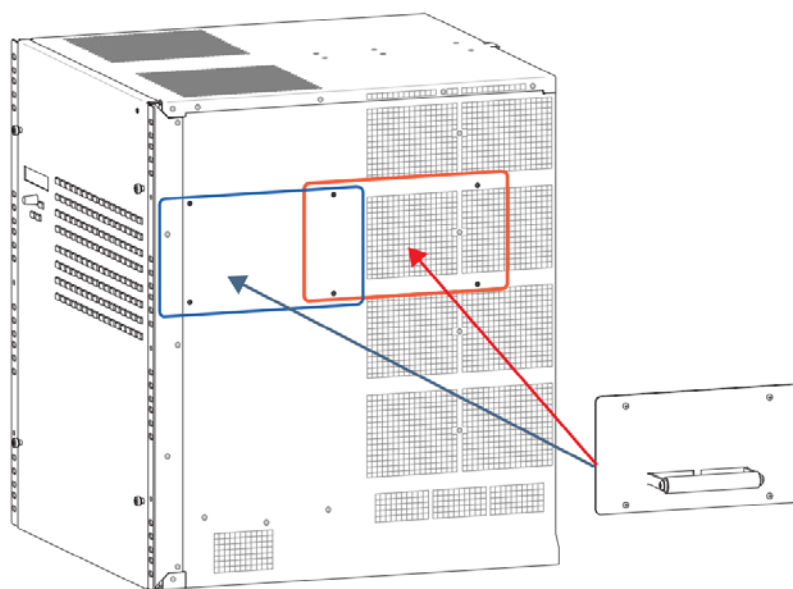

FIG. 15 DGX-6400 Lifting Handle Position Options

CAUTION: Do not use the board extractor handles to lift the enclosure or to maneuver it into place. Use the provided Lifting Handles to maneuver it. Use a temporary shelf for support.

7. Using the bottom of the shipping box, roll the enclosure into position.
8. Select a position in the rack for the enclosure that is accessible and does not restrict airflow.
9. Lift onto a temporary shelf (or some other type of support) in the rack.
10. *DGX-6400 only* - Align as closely as possible and then remove the lifting handles.
11. Lift into position and install the rack ear screws (see FIG. 16 on page 49).

Rack-Mounting DGX 800/1600/3200 Enclosures

CAUTION: Installation of DGX 800/1600/3200 Enclosures requires a minimum of two people; we recommend using three people.

1. Select a position in the rack for the enclosure that is accessible and does not restrict airflow.
2. Position the enclosure in the rack, and install the rack ear screws on each side (FIG. 16).

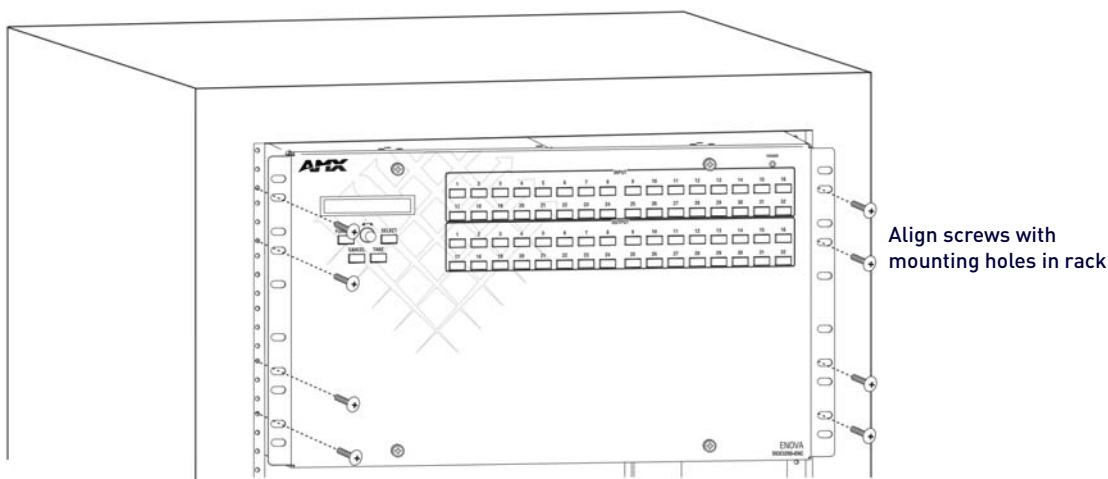

FIG. 16 Rack-Mounting DGX 800/1600/3200 Series Enclosures

Installing Boards, Connecting Devices and Powering up the DGX Enclosure

1. **Audio Insert/Extract Boards only** – Remove the boards (see FIG. 89 on page 179) and set the DIP switches to either insert or extract audio (see page 178). This is the only mechanism for configuring the insert/extract functionality.

CAUTION: On systems with DXLink Fiber Input and Output Boards, use the provided cable management bars (or some other type of cable management system) to avoid damage to the fiber cables.
2. **DXLink Fiber Boards** – Attach the provided cable management bars to the input and output boards (see page 50).
3. Attach *only* the first two source and destination devices.
 - If connecting devices to **DXLink Twisted Pair Boards**, the boards require DXLink Transmitters and Receivers. Install the Transmitters and Receivers between the first two source and destination devices and the DXLink Boards (see "System Setup with DXLink Transmitters and Receivers" on page 116 and the product's documentation).
 - If connecting devices to **DXLink Fiber Boards**, the boards require DXLink Fiber Transmitters and Receivers. Install the Transmitters and Receivers between the first two source and destination devices and the DXLink Fiber Boards (see "System Setup with DXLink Fiber, Duplex and Simplex Units" on page 139 and the product's documentation).
 - If wiring devices to **Dante Audio Switching Boards**, see page 150.
 - If wiring devices to **Audio Switching Boards**, see page 164.
 - If wiring devices to **Audio Insert/Extract Boards**, see page 175.
4. Attach power cords to all power receptacles on the enclosure, then turn on the entire system (see page 63).

CAUTION: Use a surge protector and/or an AC line conditioner.

NOTE: If an Enova DGX 3200 system contains DXLink Twisted Pair Boards, calculate the power draw for the system to maintain redundancy of power supplies in enclosure and determine how many DXLink Twisted Pair TXs and RXs can be powered via the switcher. See the Power Budget Planning for Systems with DXLink Twisted Pair Boards section on page 63 for details.

5. Launch the System Configuration interface via a browser on a PC or tablet (see page 52).

NOTE: The default Username for the interface is "administrator" and the default Password is "password". After initial setup, defaults should be changed to ensure system security.
6. Disconnect the factory default switch and execute a test switch to make sure system is working properly (see page 58).
7. When the test switch works correctly, attach the remaining source and destination devices and any additional required transmitters and receivers. If applicable, wire remaining connectors on Audio Switching Boards or Audio Insert/Extract Board(s).

Special Information for Audio Expansion Boards

Three types of audio expansion boards are available: Dante Audio Switching Boards (ASB-DAN), Audio Switching Boards (ASB) and Audio Insert/Extract (AIE) Boards.

- For Dante Audio Switching Board information, see page 150.
- For Audio Switching Board information, see page 164. If the system contains AIE Boards, the connector default settings may need to be changed for desired audio insertion or extraction functionality.
- For AIE Board information, see page 175.

Installation Options

Additional installation tasks may include the following:

- Attaching an AxLink Device – page 59
- Using the ID Pushbutton – page 60
- Setting PRD Mode – page 61
- Establishing Telnet connection with the CPU – page 256
- Establishing external serial control – page 313

Attaching Cable Management Bars

If the enclosure has DXLink Fiber Input and Output Boards installed, Cable Management Bars are provided.

CAUTION:

- *Do not severely bend or kink any type of fiber cable. Irreversible damage can occur. Refer to the physical limitations (bend radius) specified for the cable by the manufacturer.*
 - *Cable management bars are not to be used as handles to remove or install boards.*
1. **Enova DGX 3200 only** – Loosen the two captive screws that hold the Connector Numbering Plate at the top of the connectors (FIG. 17). Remove the Connector Numbering Plate and set aside.

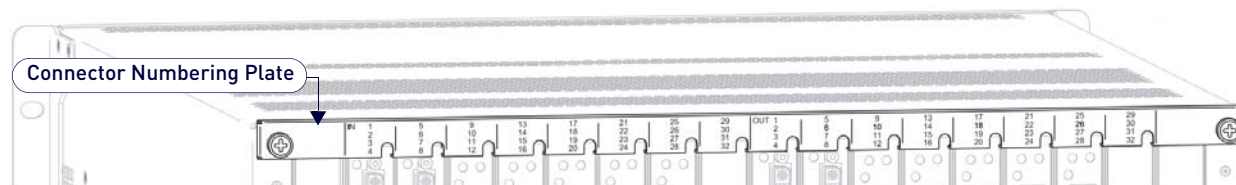

FIG. 17 Connector Numbering Plate [DGX 3200]

2. Align the two screw holes on the end of the Cable Management Bar with the two screw holes on the end of the board. Note the position of the long part of the bar in relation to screw holes (FIG. 18, FIG. 19):

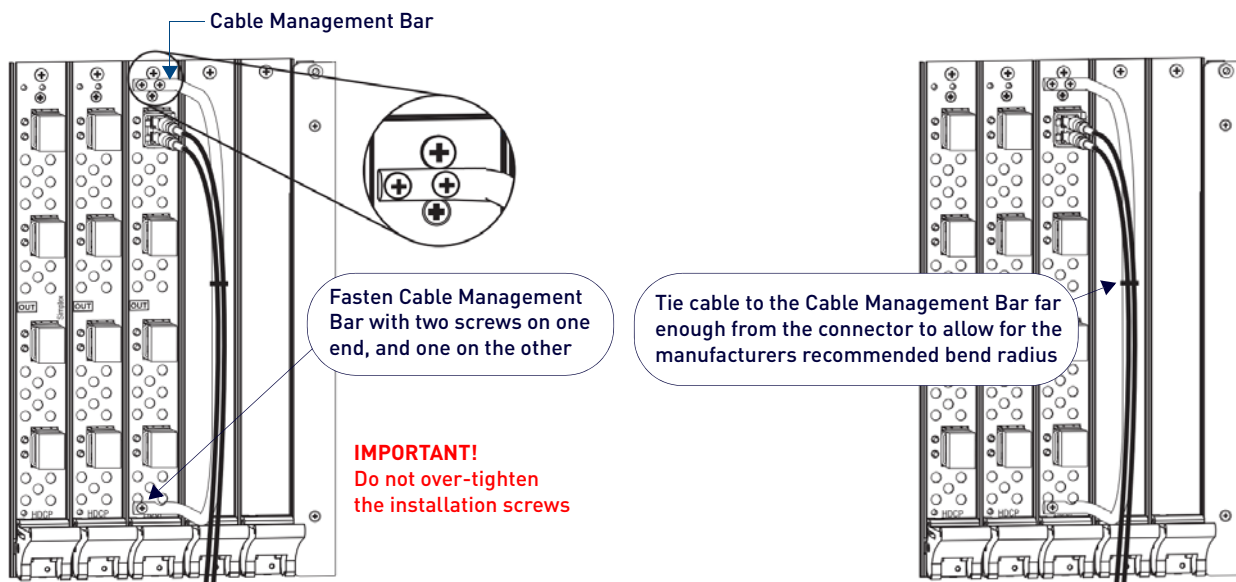

FIG. 18 Cable Management Bars - Enova DGX 3200

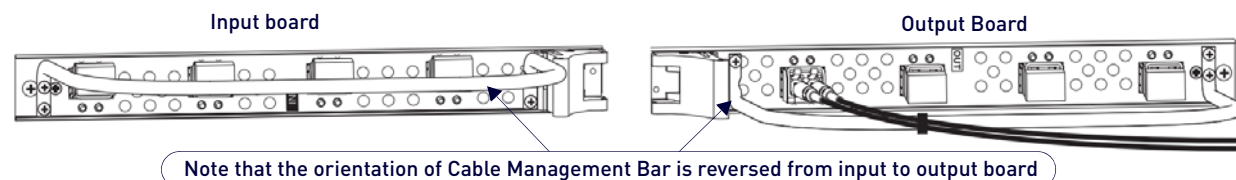

FIG. 19 Cable Management Bars - Enova DGX 800/1600/6400

3. Insert and tighten the two screws at the end of the Cable Management Bar.
4. Align, insert, and tighten the single screw at the other end of the Cable Management Bar.
5. Tie the cable to the cable management bar far enough from the connector to maintain the manufacturer's recommended bend radius.
6. *Enova DGX 3200 only* – Replace the Connector Numbering Plate that was removed in Step 1.

Attaching Video Input and Output Cables

Input and output connectors are the attachment points for source and destination devices that connect to the system.

Enova DGX 800

Viewed from the rear of the enclosure, the Enova DGX 800/1600 input boards (for attaching sources) are on the left, and the output boards (for attaching destinations) are on the right.

- DGX 800 enclosures have 4 horizontal board slots (2 slots each for the input and the output boards, with 4 connectors per board), allowing for a maximum configuration of 8x8. See FIG. 2 on page 35.
- Input and output channel numbers correspond to the connectors and are located between the input and output boards. For inputs, numbering is consecutive from left to right on each board from the top board to the bottom one; outputs start over at "1" and follow the same pattern.

Enova DGX 1600

Viewed from the rear of the enclosure, the Enova DGX 800/1600 input boards (for attaching sources) are on the left, and the output boards (for attaching destinations) are on the right.

- DGX 1600 Enclosures have 8 horizontal board slots (4 slots each for the input and the output boards, with 4 connectors per board), allowing for a maximum configuration of 16x16. See FIG. 5 on page 37.
- Input and output channel numbers correspond to the connectors and are located between the input and output boards. For inputs, numbering is consecutive from left to right on each board from the top board to the bottom one; outputs start over at "1" and follow the same pattern.

Enova DGX 3200

Viewed from the rear of the enclosure, the Enova DGX 3200 input boards (for attaching sources) are on the left, and the output boards (for attaching destinations) are on the right. See FIG. 8 on page 39.

- DGX 3200 Enclosures have 16 vertical board slots (8 slots each for the input and the output boards, with 4 connectors per board), allowing for a maximum configuration of 32x32.
- Input and output channel numbers correspond to the connectors and are located on the numbering plate (metal strip) directly above the boards. For inputs, numbering is consecutive from top to bottom on each board from the left board to right one; outputs start over at "1" and follow the same pattern.

Enova DGX 6400

The Enova DGX 6400 has input boards at the top of the enclosure's rear and output boards below. See FIG. 11 on page 42.

- DGX 6400 Enclosures have 32 horizontal board slots (16 slots each for the input and the output boards, with 4 connectors per board), allowing for a maximum configuration of 64x64.
- Input and output channel numbers correspond to the connectors and are located in the middle of the enclosure between boards on either side. For inputs, numbering is consecutive from left to right on each board from the top input board on the left to the bottom input board on the left, continuing on the top input board on the right to the bottom input board on the right. Outputs start over at "1" and follow the same pattern.

Cabling Specific Connector Types

For information on board connectors and cabling and specifications for specific types of connectors:

- HDMI 4K60 Boards – page 81
- HDMI Boards – page 95
- DVI Boards – page 106
- DXLink Twisted Pair Boards – page 112
- DXLink Twisted Pair 4K Boards – page 123
- DXLink Fiber Boards – page 134

Input and Output Signal Cables

CAUTION: *If you are connecting switching systems via their DXLink ports (applies to DXLink Twisted Pair 4K Boards, DXLink Twisted Pair Boards, and DXLink Fiber Boards), be sure to read the information on page 125 (DXLink Twisted Pair 4K), on page 118 (DXLink Twisted Pair), and on page 144 (DXLink Fiber).*

If using cable management bars, install them before attaching the cables (see page 50).

Before connecting all of the input and output cables and wires, attach only the ones for the first two sources and destinations (and any applicable transmitters and receivers). Complete the remaining installation tasks (applying power and any system setup through the System Configuration interface), and then disconnect the factory default switch and execute a test switch (see page 58). When the test switch is successful, attach the remaining input and output cables and wires.

Wiring Audio Inputs and Outputs

Enova DGX Switchers can include the following audio expansion boards: Dante Audio Switching Boards (ASB-DAN), Audio Switching Boards (ASB) or Audio Insert/Extract (AIE) Boards. Audio expansion boards work in conjunction with HDMI, 4K HDMI, DVI, DXLink Twisted Pair 4K, DXLink Twisted Pair, and DXLink Fiber Boards. The inputs and outputs are configured on a per connector basis to route audio into, out of, or through the system.

CAUTION: *Audio Switching Boards, Dante Audio Switching Boards, and Audio Insert/Extract Boards are not compatible. Do not install mixed types of expansion boards in the same enclosure. If two types of boards are present, the audio subsystem is disabled.*

IMPORTANT: *Audio Insert/Extract Boards Only - Setting the DIP switches is the only mechanism for configuring insert/extract functionality on the Audio Insert/Extract Board. Therefore, setting the switches (which requires removal of the board from the enclosure) needs to be done at the time of installation setup.*

For information on board connectors and wiring and specifications for specific types of connectors:

- Dante Audio Switching Boards (ASB-DAN) – page 164
- Audio Switching Boards (ASB) – page 164
- Audio Insert/Extract Boards (AIE) – page 175

Refer to the following figures for the locations of the Expansion Board Slots on each DGX 100 Series Enclosure:

- DGX-800: FIG. 2 on page 35
- DGX-1600: FIG. 5 on page 37
- DGX-3200: FIG. 8 on page 39
- DGX-6400: FIG. 11 on page 42

System Setup for Using the Integrated NetLinx NX Master

The Enova DGX 100 Series Switcher has an integrated NetLinx NX Central Control Processor (Master) that establishes its public LAN (Local Area Network) connection through the LAN 100/1000 port on the CPU. The Master provides a System Configuration interface that allows you to make various configuration settings via a web browser on any PC connected to the public LAN. The NX Master's on-board System Configuration interface delivers HTML pages for setting up the system plus dedicated Switching, Configuration, and Status pages which allow for remote control and monitoring of an Enova DGX Switcher using PC-based Internet browsing software.

IMPORTANT: *The Enova DGX Switcher uses DHCP to retrieve its IP address by default. The integrated Master's IP address is available via the control panel at Setup Options/Master Info/IP Address.*

The enclosure must be connected to a LAN in order to get an IP address from a DHCP server. After the network assigns a DHCP IP address, a static IP address can be assigned in its place.

IMPORTANT: *Although it is also possible to provide access from outside a LAN via the Internet, security issues for your LAN environment must be taken into account (contact your Network Administrator).*

System Setup Overview

IMPORTANT: *The Enova DGX Switcher uses DHCP by default.*

The LAN 100/1000 (Ethernet) port provides functionality for the following protocols: FTP, SSH, Telnet, HTTP, HTTPS/SSL, and ICSP (for protocol descriptions and standard port numbers used, see the table on page 54). This port is connected to a public LAN. By default, the integrated Master will receive an IP address from the LAN it connects with (via DHCP). Once the System Configuration interface has been launched and a test switch has been completed, it will be possible to reconfigure the integrated Master's LAN 100/1000 port IP setting from DHCP to Static IP (see page 201).

FIG. 20 shows a DGX 3200 connected to a LAN via the LAN 100/1000 port. Both computers in the figure have access to the enclosure via the LAN.

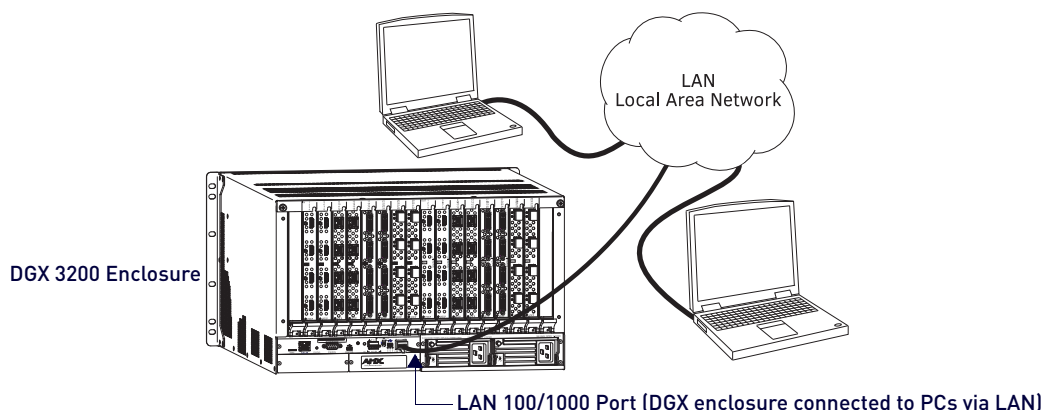

FIG. 20 Enova DGX 3200 connected via a LAN to two PCs

CAUTION: *Be careful not to create a network (Ethernet) loop. To avoid doing so, see page 130 (DXLink Twisted Pair 4K modules), page 119 (DXLink Twisted Pair modules), and/or see page 134 (DXLink Fiber modules).*

RJ-45 Ports

The Enova Series CPU has two RJ-45 ports: the ICS LAN port on the left and the LAN 100/1000 port on the right. The ICS LAN port acts as a DHCP server (private LAN) and the LAN 100/1000 port acts as a DHCP client (public LAN) with each port on a separate network.

CAUTION: In order to avoid a Network Loop, do not connect any device on the private LAN (ICS LAN port) to any branch on the public LAN (LAN 100/1000 port).

Both of the RJ-45 ports indicate the same type of LED information and use the same pinouts for cabling.

RJ-45 Port LEDs

The two small rectangular LEDs on the RJ-45 connector indicate the following:

- Green L/A LED: On – Link is active (when the Ethernet cable is connected and terminated correctly)
- Yellow SPD LED: On – receiving or transmitting LAN data packets

ICS LAN 10/100 and LAN 100/1000 Indicator LEDs

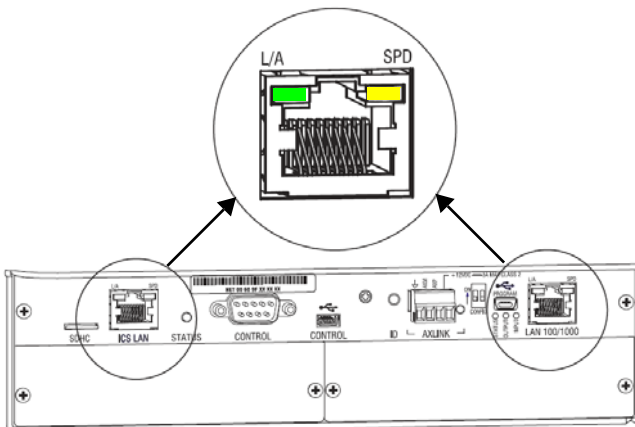

FIG. 21 ICS LAN 10/100 and LAN 100/1000 port LED indicators

Cable Requirements and Pinouts

RJ-45 link cable (either crossover or straight-through) – required to connect an Enova DGX Switcher to the public LAN.

NOTE: Cable can be wired to either T568A (see below) or T568B (on the next page), as long as the wiring is consistent on both ends.

T568A

The following table lists the pinouts, signals, and pairing for the Ethernet connector when wired for straight-through cable according to T568A.

T568A				
Pin	Signals	Connections	Pairing	Color
1	TX+	1-----1	1-----2	Green - White
2	TX-	2-----2		Green
3	RX+	3-----3	3-----6	Orange - White
4	No connection	4-----4		Blue
5	No connection	5-----5		Blue - White
6	RX-	6-----6		Orange
7	No connection	7-----7		Brown - White
8	No connection	8-----8		Brown

T568A Pairing

connections for Ethernet RJ-45 connector/cable per T568A

T568B

The following table lists the pinouts, signals, and pairing for the Ethernet connector when wired for straight-through cable according to T568B.

T568B				
Pin	Signals	Connections	Pairing	Color
1	TX+	1-----1	1-----2	Orange - White
2	TX-	2-----2		Orange
3	RX+	3-----3	3-----6	Green - White
4	No connection	4-----4		Blue
5	No connection	5-----5		Blue - White
6	RX-	6-----6		Green
7	No connection	7-----7		Brown - White
8	No connection	8-----8		Brown

T568B Pairing

connections for Ethernet RJ-45 connector/cable per T568B

ICS LAN 10/100 Port

The ICS LAN 10/100 port on the left-hand side of the CPU is the access point for communication with devices on the private (ICS LAN) network. The port has a built-in DHCP server which serves IP addresses for the private LAN to endpoint devices.

LAN 100/1000 Port

The LAN 100/1000 (Ethernet) port, which provides the connection from the integrated NetLinX NX Master to a public LAN, is located on the rear of the enclosure on the right-hand side of the CPU. The port handles Ethernet 10/100/1000 connections for 1000 Mbps (megabits per second), 100 Mbps, and 10 Mbps. This connection is compatible with most Ethernet based LANs.

IMPORTANT: Because the LAN 100/1000 port is the single, shared connection to the public LAN, a Gigabit (1000 Mbps) LAN connection between the network and the Enova DGX Switcher's LAN 100/1000 port is strongly recommended. Lower speed connections may result in inferior performance of the embedded Ethernet network.

CAUTION: The ICS LAN port acts as a DHCP server (private LAN) and the LAN 100/1000 port acts as a DHCP client (public LAN) with each port on a separate network. In order to avoid a Network Loop, do not connect any device on one network to any branch on the other network.

IP Protocols Used by the Enova DGX Integrated Controller

IP Protocols Used by the Integrated Controller		
Protocol	Description	Standard Port #
FTP	The integrated Master has a built-in FTP server	21/20 (TCP)
SSH	The SSH port functions using the same interface as Telnet but over a secure shell where it uses SSL as a mechanism to configure and diagnose a NetLinX system. This port value is used for secure Telnet communication. <i>Note: Only SSH version 2 is supported.</i>	22 (TCP)
Telnet	The NetLinX Telnet server provides a mechanism to configure and diagnose a NetLinX system. For maximum flexibility, the Master can be configured to use a different port than 23 or disable Telnet completely from either Telnet or the Program port on the rear of the Enova DGX Switcher. Once disabled, the only way to enable Telnet again is from the Program port.	23 (TCP)
HTTP	The integrated Master has a built-in web server that complies with the HTTP 1.0 specification and supports all of the required features of HTTP v1.1. This port is used for unsecured HTTP Internet communication between the web browser's UI and the integrated Master.	80 (TCP)
HTTPS/SSL	This port is used by a web browser for secure communication between the web server UI and the integrated Master. This port is also used for simultaneous encryption of this data, using the SSL certificate information on the Master as a key.	443 (TCP)
ICSP	The port is used for peer-to-peer protocol for both Master-to-Master and Master-to-device communications. This type of communication is used by various AMX products for communication among themselves (see page 204). <i>Note: The integrated Master can only be configured to use Port 1319, and the ICSP cannot be disabled.</i>	1319 (UDP/TCP)

Avoiding Network (Ethernet) Loops

Only one connection to the Public LAN is permitted within a switching system with DXLink support.

NOTE: This applies to systems with DXLink Twisted Pair and/or DXLink Fiber Boards.

Network loops must be avoided. A network loop is created when the enclosure and one or more DXLink Modules or Wallplates within the system are connected to the same Public LAN as the Enova DGX. The Enova DGX Switcher does not support STP (Spanning Tree Protocol).

IMPORTANT: If DXLink Twisted Pair units are used in conjunction with DXLink Twisted Pair 4K units or DXLink Fiber units, all units' guidelines must be followed.

FIG. 22 indicates a network loop created when an Enova DGX 1600 was connected to a Public LAN and one of its DXLink Transmitters was connected to the same LAN. In this case, the DXLink Transmitter needs to be disconnected from the LAN. The same problem would also occur if an enclosure and one (or more) of its DXLink Receivers were connected to a common Public LAN.

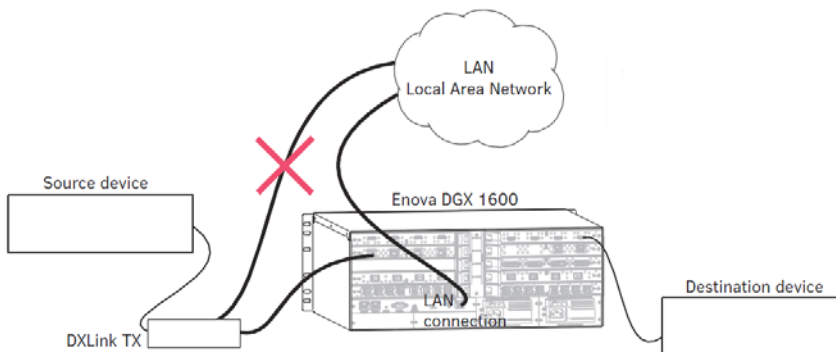

FIG. 22 Avoid network loops - DXLink TX

IMPORTANT: If the system has DXLink input and output connectors in use, the LAN 100/1000 port should use a connection speed of 1000 Mbps.

FIG. 23 indicates a network loop created when an Enova DGX 1600 was connected to a Public LAN and one of its DXLink Receivers was connected to the same LAN. In this case, the DXLink Receiver needs to be disconnected from the LAN:

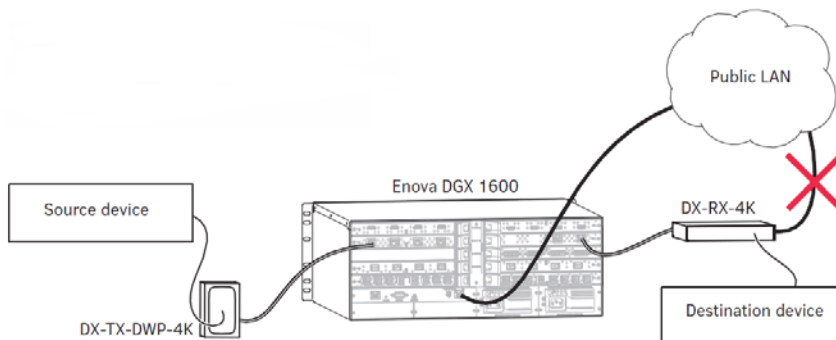

FIG. 23 Avoid Network Loops - DXLink Receiver

IMPORTANT: If DXLink Twisted Pair 4K units are used in conjunction with DXLink Twisted Pair or DXLink Fiber units, all units' guidelines must be followed.

FIG. 24 indicates a network loop created when an Enova DGX 1600 was connected to a Public LAN and one of its DXLink Fiber, Duplex Transmitters in Bidirectional Mode was connected to the same Public LAN as the Enova DGX. In this case, the DXLink Fiber, Duplex Transmitter needs to be disconnected from the LAN.

The same problem would also occur if an enclosure and one (or more) of its DXLink Fiber, Duplex Receivers were connected to a common Public LAN.

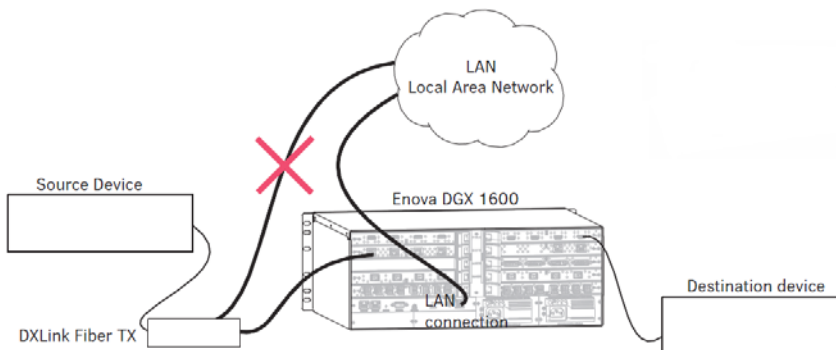

FIG. 24 Avoid network loops

IMPORTANT: For Duplex hardware in Bidirectional Mode connected to an Enova Digital Media Switcher, we recommend connecting the switcher to the network for all network connection needs. Network connections via the switcher are faster and more reliable. Never connect both a TX and RX, a TX and switcher, or a switcher and RX to the same network: Avoid network loops.

CAUTION: If you have questions or concerns about network setup, consult with your network administrator about avoiding network loops before connecting units.

Connecting an Enova DGX to a Public LAN via the LAN 100/1000 Port

IMPORTANT: In order to use the on-board System Configuration interface, the Enova DGX Switcher must establish an active connection to a public LAN. **Do not connect the LAN 100/1000 port on the Enova DGX Switcher to a PC; it will not work.**

1. Insert one end of the RJ-45 link cable into the LAN 100/1000 port on the enclosure.
2. Connect the other end of the RJ-45 link cable to a LAN hub or switch. The network automatically assigns a DHCP IP address (the assigned IP address can be changed to a static IP address).

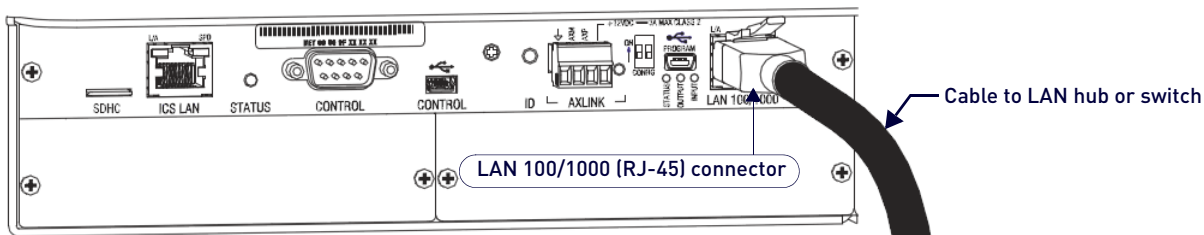

FIG. 25 RJ-45 link cable connected to LAN 100/1000 port

3. Check the indicator LEDs for the LAN 100/1000 connector (see page 53).

NOTE: When the connection is made, the DHCP server on the network will automatically assign an IP address. If you power down and power back up, the DHCP server will reassign the IP address, which may or may not be the same address it assigned before. To prevent the possibility of the IP address changing at power up, you can change the DHCP address to a static IP address (see the NetLinx NX Central Controllers WebConsole & Programming Guide at www.amx.com). The integrated Master's IP address is available via the control panel at Setup Options/Master Info/IP Address.

Confirming Board Versions

Enova DGX enclosures and boards typically ship with the latest firmware available. If the firmware on any board installed in the enclosure does not match the firmware version the enclosure expects, a firmware mismatch occurs. To resolve a firmware mismatch, the latest available firmware .kit file (which contains firmware for both boards and enclosure) must be sent to the enclosure.

1. Launch NetLinx Studio and connect to the DGX Master.
2. Open the OnLine Tree tab, right-click in the Workspace Bar field and select Refresh System Online Tree.
3. Expand the 5002 device and confirm compatible board versions (or mismatch).
4. If a mismatch is present, send the latest firmware .kit file to the enclosure.

NOTE: Instructions for sending a .kit file are located on page 203.

System Configuration Interface Setup

System Requirements

Minimum web browser requirements – Google Chrome v30, Internet Explorer v10, Firefox v24, Safari v6.0, Opera v24, or other browser with substantial support for HTML5 features

NOTE: *User experience may differ due to browser support for HTML5.*

Setting up the system to use AMX's System Configuration interface requires completing the following three items. Detailed instructions for each item are given.

- Determine the integrated Master's IP address via the front Control Panel
- Open a web browser on the PC. Note that the PC (or tablet) must be on the same LAN that the enclosure is connected to via the LAN 100/1000 port.
- Open the System Configuration interface

NOTE: *Place source and destination devices within view until the test switch confirms correct routing behavior. Any applicable modules/wallplates should be correctly installed and power must be applied to both the enclosure and source and destination devices.*

The steps below assume that the DGX is powered on and connected to the LAN via the LAN 100/1000 port (FIG. 25).

Logging On To the System Configuration Interface and Executing a Test Switch

NOTE: *The System Configuration interface can also be launched via NetLinx Studio (see page 209).*

1. Determine the integrated Master's IP address:
 - a. On the front Control Panel, locate **Setup Options** by scrolling with the Control Dial.
 - b. Press the **Select** key.
 - c. Locate **IP Address** by scrolling with the Control Dial.
 - d. Press the Select key to display the IP Address.
 - e. Record the IP address for use in Step 3.
2. On a PC or tablet, open a web browser that supports HTML5.
3. In the web browser's address bar, enter the Enova DGX's IP address and press Enter. The System Configuration interface's Home page appears in the browser.

IMPORTANT: *The default Username for the interface is "administrator" and the default Password is "password". After initial setup, defaults should be changed to ensure system security.*

4. From the main menu bar at the top of the screen, select Switcher>Switching. The Switching page appears.
5. Disconnect the factory default switch (Input 1 routed to all Outputs):
 - a. Click Input 1.
 - b. Under outputs, select **Deselect All**.
 - c. Click **Take**.
6. Make sure the first two source devices and the first two destination devices are connected to the first two input and output connectors (for specific board connector information and specifications, see the board chapter).
7. Route Input 1 to Output 2 (click Input 1, then Output 2, then click the **Take** button).
8. To verify the switch, click Input 1 again. Both the Input 1 and Output 2 buttons will turn blue and both selections will appear in the Selected pane on the right.
9. Disconnect the test switch (click Output 2 and click Take) and finish the installation.

For System Configuration interface tips, see page 201.

NOTE: *For instructions on executing a test switch via BCS Commands, see the "BCS (Basic Control Structure) Protocol Programming Guide" at www.amx.com.*

Additional Setup Options

- Audio Control and Signal Processing (see the following page)
- Establish serial communication with a PC via the Program port (see page 58)
- Attaching an AxLink device (see page 59)
- Using the ID Pushbutton (see page 60)
- Enable Program Run Disable (PRD) Mode (see page 61)

Audio Control and Signal Processing Options

Audio Switching Boards (ASB)

The audio signal on Audio Switching Boards can be switched independently of the video or as embedded audio. These boards also allow for digital signal processing (e.g., volume, equalizer, input gain) on every input and every output in the enclosure. When using Audio Switching Boards, the Enova DGX 6400 requires two each of the input and output boards for functionality. Both boards are provided as part of the compatible DGX6400-ASB Audio Switching Board Kit for the Enova DGX 6400.

NOTE: *The Audio Insert/Extract Board has no control options aside from the configuration of DIP switches. All switching of audio is executed in conjunction with the switches executed on the corresponding input and output connectors (for additional information, see the Audio Insert/Extract Board chapter on page 175).*

System Configuration Interface

- Switching audio outputs/inputs – page 185
- Switching a down-mixed signal – page 188
- Configuring audio outputs/inputs – page 131

ICSP Commands

- Switching audio outputs/inputs – page 209
- Digital Signal Processing audio commands – page 225

Control Panel

NOTE: *Audio from Audio Switching Boards cannot be switched independently from the Control Panel. When the audio from the boards is embedded on a video signal, only volume, input gain, and mute can be applied from the Control Panel.*

- Volume – page 75
- Input gain – page 76
- Mute – page 75

BCS Commands

- Volume, input gain, and mute – See the *BCS (Basic Control Structure) Protocol Programming Guide* at www.amx.com.

Establishing Serial Communication with a PC via the Program Port

Program Port

The Enova DGX Switcher's integrated NetLinx NX Master is equipped with a low-speed USB connection labeled "Program." Use the provided USB mini-AB adapter cable (CA1090-541) to establish a connection between the Program port on the enclosure and the PC's USB port.

This connection provides serial-based communication between the integrated Master and NetLinx Studio. This port is useful for getting and setting the system's IP address (in NetLinx Studio, open Tools/Telnet Session and enter either GET IP <D:P:S> or SET IP <D:P:S>, where D:P:S is Device:Port:System).

IMPORTANT: *The Program port is not recommended for firmware updates or large file transfers. These more data-intensive operations are better handled via the LAN 100/1000 port connection.*

Cable Requirements

USB mini-AB adapter cable (provided) – required to connect an Enova DGX Switcher via its Program port to a PC.

Program Port LEDs – Modes and LED Blink Patterns

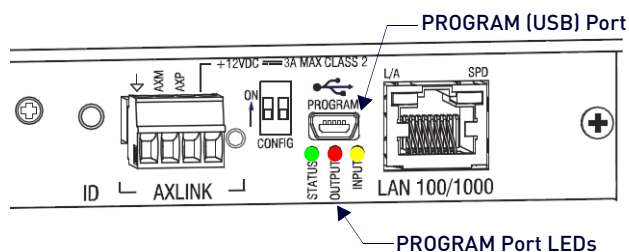

FIG. 26 Program Port LEDs

The following table lists the modes and the blink patterns for the Program port's LED indicators which are associated with each mode. These blink patterns are not evident until the unit is powered.

Modes and LED Blink Patterns				
Mode	Description	LEDs and Blink Patterns		
		Status (Green)	Output (Red)	Input (Yellow)
OS Start	Starting the operating system (OS).	On	On	On
Boot	Integrated Master is booting.	On	Off	On
Contacting DHCP Server	Integrated Master is contacting a DHCP server for IP configuration information.	On	Off	Fast Blink
Unknown DHCP Server	Integrated Master could not find the DHCP server.	Fast Blink	Off	Off
Downloading Boot Firmware	Downloading Boot firmware to the integrated Master's flash memory. <u>Do not</u> cycle power during this process.	Fast Blink	Fast Blink	Fast Blink
No program running	Either no program is loaded or the program is disabled.	On	Normal*	Normal*
Normal	Integrated Master is functioning normally.	1 blink per second	On indicates activity	On indicates activity

* "Normal" is typically off. However, this state may change depending on external inputs.

Attaching an AxLink Device

The CPU board has an AxLink port and an adjacent AxLink LED on its right. The AxLink port is a 4-pin mini-Phoenix (female) captive-wire connector. This port allows the integrated Master to support AMX AxLink devices.

The AxLink port can be used to supply power to downstream AxLink-compatible devices as long as the power required does not exceed 2 Amps .

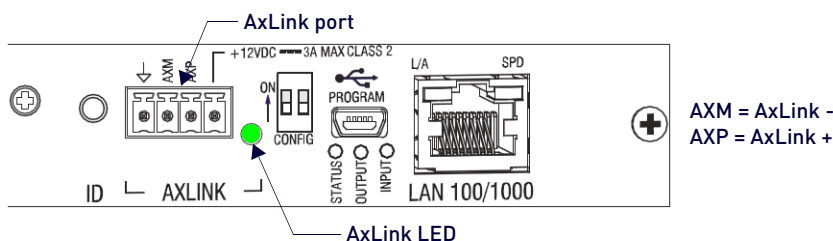

FIG. 27 AxLink Connector and LED

AxLink LED

A green AxLink LED indicates AxLink data activity. "Off" indicates either no power or the Master is not functioning properly. When the AxLink port is operating normally, LED blink patterns include:

- 1 blink per second – Normal operation.
- 3 blinks per second – AxLink bus error. Check all AxLink bus connections.

Using the AxLink Connector for Data and Power

To supply data and power to an AxLink compatible device, wire the AxLink connector as shown in FIG. 28:

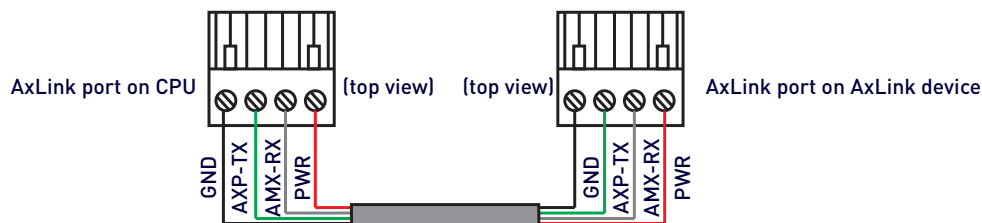

FIG. 28 AxLink connector wiring diagram (direct data and power)

AxLink Device Numbering

For NetLink programming purposes, each AxLink device must be assigned a unique number to locate that device on the bus. The range for AxLink device numbers is 1-255. AMX best practices requires assigning device numbers in three groups:

- Access Control Cards: 1 - 95
- Access Bus Boxes: 96 - 127
- Access Panels/Receivers: 128 - 255

NOTE: If you are familiar with binary, start at Step 3 and set the device's DIP switch toggles accordingly (zero = all up; 255 = all down).

Setting an AxLink Device Address

1. Open NetLinx Studio and select Tools>DIP Switch. The DIP Switch 2.0 applet appears.
2. Enter the AxLink device number in the Device Number text box and note toggle positions. Close the applet.
3. On the bottom/side of the AxLink device, set the device's DIP switch toggles to an appropriate device number according to AMX best practices (see established ranges above).
4. Connect AxLink cables from the AxLink device to the AxLink port on the Enova DGX CPU.
5. In NetLinx Studio, select the OnLine Tree tab and refresh the OnLine Tree with the Enova DGX displayed. The AxLink device appears as a device in the OnLine Tree.

AxLink Power Measurement and Control

The AxLink port on the CPU supports a SEND_COMMAND to turn on and off +12V power output on the port.

- `AXPWON LOWER` – turns on power output on port
- `AXPWROFF LOWER` – turns off power output on port

These messages are always sent to port 1 of the 5001 control device (D:P:S = 5001:1:0) and return status comes from the same port.

AxLink Port Diagnostics

The fault state can be queried using the SEND_COMMAND: `GET AX FAULT (D:P:S = 5001:1:0)`.

- The reply to normal operating status is: `AX FAULT: NONE`
- The reply to a problem in operating status is: `AX FAULT: BUS`

Removing the problem should restore the fault state to `NONE` without intervention.

NOTE: *Shorting the bus power does not cause a fault that `GET AX FAULT` can detect.*

Using the ID Pushbutton

The ID Pushbutton for the integrated Master is located on the rear of the enclosure on the CPU board to the left of the AxLink Port (FIG. 29):

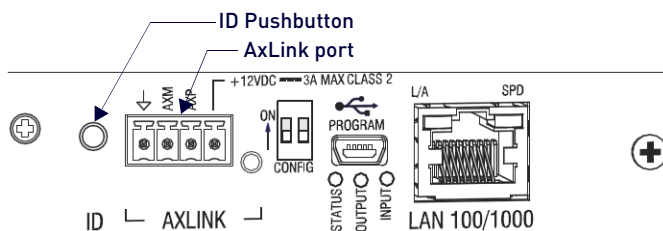

FIG. 29 ID Pushbutton

The ID Pushbutton can be used to perform three types of initial configuration settings:

- Toggle between DHCP (default) and static IP addressing (see below).
- Reset the switcher to its factory default settings, which affects the settings but not the firmware version (page 60).
- Restore the switcher to its factory firmware image, which affects both the firmware version and the settings (page 61).

NOTE: *ID Pushbutton functions can also be implemented using Telnet commands (see the "WebConsole & Programming Guide – NetLinx NX Central Controllers" at www.amx.com).*

Toggling Between DHCP and Static IP Addressing

1. Verify that the Master is not currently booting.
2. Press and hold the ID Pushbutton for 10 seconds or longer.
3. Release to toggle between static and dynamic IP addressing. The Master will automatically reboot to complete the process.

NOTE: *The default static IP address is 192.168.1.2 with a 255.255.255.0 subnet mask.*

Resetting the Factory Default Settings:

A reset of the Master to factory default settings includes the removal of all security settings and user files (including all code and IRL files), resetting to DHCP, and loading an empty NetLinx program. Once reset, the Master will be effectively in an out-of-box state.

1. Verify that the Master is currently booting.

NOTE: *The Master is booting when the Program port Status and Input LEDs are ON (green and yellow respectively) and the Output LED (red) is OFF.*

2. During the boot process, press and hold the ID Pushbutton for 10 seconds or longer.

CAUTION: *Do not press longer than 10 seconds. Pressing the ID Pushbutton for 20 seconds restores the factory firmware image on the Master.*

3. Release to reset to the factory defaults.

Restoring the Factory Firmware Image and Factory Default Settings

1. Verify that the Master is currently booting.

NOTE: *The Master is booting when the Program port Status and Input LEDs are ON (green and yellow respectively) and the Output LED (red) is OFF.*

2. Press and hold the ID Pushbutton for 20 seconds or longer.
3. Release the pushbutton.

Program Run Disable (PRD) Mode

IMPORTANT: *The information in this section is not applicable when the system is running under normal operating conditions. The PRD mode should only be used if the resident NetLinx program is causing inadvertent communication and/or control problems.*

If necessary, use NetLinx Studio (v4.0 or later) to resolve communication and/or control problems with the resident NetLinx program. PRD mode prevents the NetLinx program stored in the integrated Master from running during the Enova DGX enclosure's power-up.

PRD mode (ON) equates to a "SAFE" mode setting on a PC: it allows powering the unit, updating the firmware, and downloading a new program, while circumventing any problems with a currently downloaded program.

Power must be cycled to the enclosure after activating/deactivating the PRD mode.

NOTE: *DIP switch #2 must remain in the DOWN (default) position.*

Setting the Config DIP Switch To Place the Integrated Master in PRD Mode

NOTE: *The DIP switch is mounted with the ON position at the top (as indicated by the arrow on the left).*

1. Set the Position #1 DIP switch to ON to place the integrated Master into PRD mode (FIG. 30).

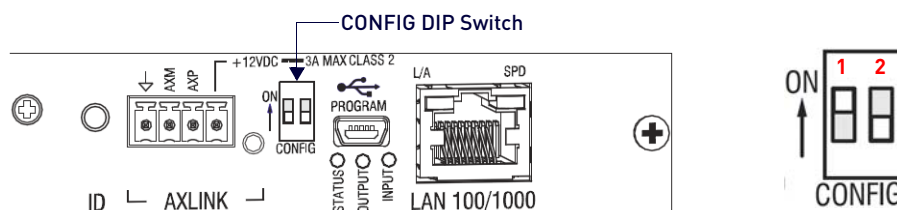

FIG. 30 CONFIG DIP Switch

2. Cycle power on the enclosure.
3. Use NetLinx Studio (v4.0 or later) to resolve the communication and/or control problems with the resident NetLinx system/project.
4. Download the corrected system/project.
5. Reset the DIP switch to OFF (places integrated Master back into Normal mode).
6. Cycle power on the enclosure.
7. Try communication and/or control again.

Troubleshooting and Technical Support

Troubleshooting

This manual addresses a number of topics with troubleshooting sections and tips appearing as they apply. The sections below list each of these appearances with linked page references to troubleshooting advice. If the troubleshooting advice does not answer a particular question, the text above or below the advice should also be consulted as those areas may contain relevant material. If the manual has not addressed your particular problem, contact Technical Support.

Enova DGX Switcher Hardware Troubleshooting

- General boards – page 26
- DXLink Fiber Boards – page 148
- Dante Audio Switching Boards – page 162
- Audio Switching Boards – page 174
- AIE Boards – page 182
- Test switches – page 70
- Control panel error codes – page 79
- Power supplies – page 65
- CPU troubleshooting after setting PRD Mode Dip switches – page 61
- CPU troubleshooting after replacing the CPU battery – page 246
- AxLink port diagnostics – page 60

Video and Audio Troubleshooting

- HDCP video output – page 104
- Audio, EDID / support / problems / solutions – page 105

AMX Software Troubleshooting

- NetLinx Studio connection – page 202
- System Configuration interface setup – page 57
- Communication and/or control problems (PRD mode) – page 61
- System Configuration interface proxy settings – page 243
- DGX Configuration Software – page 298

Contacting Technical Support

If this manual has not satisfactorily answered your questions regarding the Enova DGX Switcher or the system is not operating as expected, please contact your AMX representative or technical support. Have the serial numbers for your system and any applicable AMX accessory devices ready (the numbers are normally located on the rear of the enclosure or accessory devices).

We recommend recording your system's serial numbers in an easily accessible location.

AMX Contact Information

- 3000 Research Drive, Richardson, TX 75082
- 800.222.0193
- 469.624.8000
- Fax 469.624.7153
- Technical Support 800.932.6993
- www.amx.com

Applying Power and Startup

Overview

The enclosure's universal power receptacles will accept all major international standard power sources. Two US power cords are included with all enclosures shipped within the US. Maximum power specifications are on each power receptacle (and are also listed on page 20). Always use earth-grounded power cords and equipment with an Enova DGX Switcher.

The source electrical outlet(s) should be installed near the enclosure, easily accessible, and properly grounded. Power should come from a building branch circuit. We strongly recommend using a dedicated line for the system's power. Use a minimum breaker current rating of 20 A for 110 V or 10 A for 230 V for each circuit. To avoid an overload, note the power consumption rating of all the equipment connected to the circuit breaker before applying power.

Power Budget Planning for Systems with DXLink Twisted Pair Boards

If an Enova DGX 3200 system contains DXLink Twisted Pair Boards, be sure to read the section on "Power Budget Planning" in board chapter. The power draw for the system should be calculated in order to maintain the power redundancy of the power supplies in the enclosure. Calculating the power draw also helps determine how many DXLink Transmitters and Receivers can be powered via the switcher.

Complete Power Redundancy Setup

IMPORTANT: For proper redundant operations, all power supplies must be powered at all times.

Enova DGX 800/1600/3200 – To take full advantage of the multiple power feeds and redundant power supplies, cable the primary power feed to an outlet connected to one circuit breaker. The redundant power feed should be cabled to an outlet connected to a second circuit breaker (FIG. 31).

Enova DGX 6400 – To provide adequate power for an N+1 redundant application, connect each of the power supplies to its own circuit.

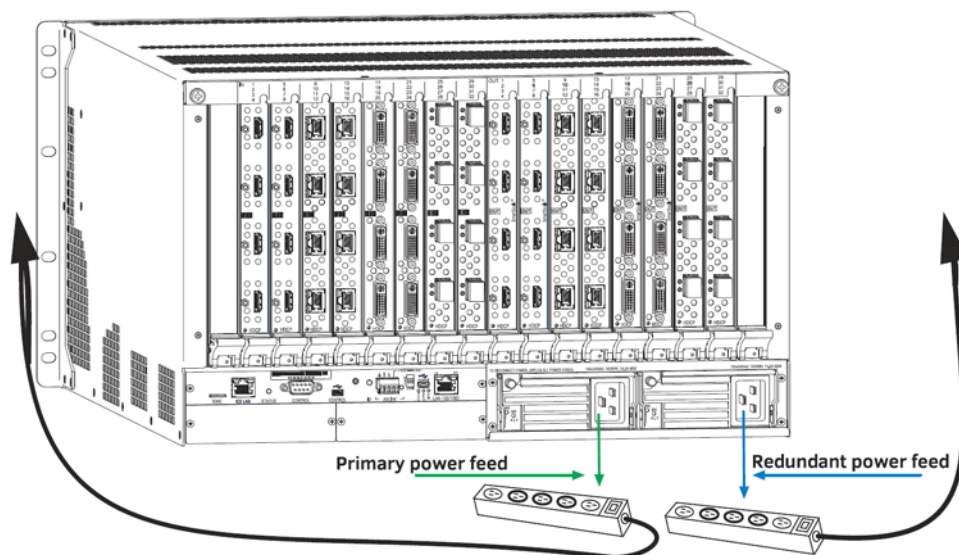

FIG. 31 Power setup for complete redundancy on Enova DGX 3200

CAUTION: Attach all power cords to a surge protector and/or an AC line conditioner.

Power-Up Sequence

NOTE: *Enova DGX 6400 only* - Four AC power filtering Ferrites (one per cord) are provided to ensure the system meets or exceeds the radiated emission requirements defined in standards EN55022:2010, FCC 15.109(g):2014, and ICES-003:2012. To install these filters, clamp in place onto the power cords as close to the power supply as reasonably possible for the system.

IMPORTANT: *Enova DGX 6400 only* – If two or more power supplies are not receiving power, shut down power to all power supplies then restart the system with all power supplies connected.

The following instructions start with attaching only two source and destination devices for the purpose of executing a test switch (after the factory default switch is disconnected).

Applying Power

- Attach the first two source and destination devices (attach the remaining devices in Step 9 after executing the test switch in Step 8).
Do not apply power to the source and destination devices until Step 7.
 - If connecting devices to DXLink Twisted Pair Boards, the boards require DXLink Transmitters and Receivers. Install the Transmitters and Receivers between the first two source and/or destination devices and the DXLink Boards (see "System Setup with Transmitters and Receivers" section in the board chapter and the product's documentation).
 - If connecting devices to DXLink Fiber Boards, the boards require DXLink Fiber Transmitters and Receivers. Install the Transmitters and Receivers between the first two source and/or destination devices and the DXLink Fiber Boards (see "System Setup with DXLink Fiber, Duplex Units" on page 139 and the product's documentation).
- Plug power cords into *all* of the power receptacles (two or four depending on the system) on the enclosure simultaneously.
- Plug the other end of each power cord into its power source (if using a power strip, turn on the power strip).
- Wait 30 seconds.
The Power indicator LED on the Front Panel illuminates green (showing that all redundant power supplies are working). (The LCD on the Control Panel also illuminates and displays the menu screen.)
 - Enova DGX 800/1600/3200** – if one power supply is not working, the Power indicator will be a constant red (check power connections and switches).
 - Enova DGX 6400** – if one power supply is not working, the Power indicator will be a constant red; if two or three power supplies are not working, the Power indicator will flash red (check power connections and switches).
- Optional – Apply power to a control device/system.
- For systems with **DXLink Fiber Boards** – Apply power to the DXLink Fiber TX and RX units.
- Apply power to the source and destination devices.
- Disconnect the factory default switch and execute a test switch (see page 70).
- Attach the remaining sources and destinations and apply power to them.

IMPORTANT: Whenever the system is powered down, be sure the indicator LEDs on the CPU are off and the fans have stopped before reapplying power.

Indicator Lights at Startup

When the enclosure powers up, the indicator LEDs respond as follows:

Enova DGX LED Indicators				
	LED	Indicates	Normal Display	Cautionary
Front	Power	System power status	Constant green	Constant red: one power supply is not working Enova DGX 6400 only - <ul style="list-style-type: none"> Constant red: one power supply is not working Flashing red: two or three power supplies are not working Flashing green: System in upgrade process*
Rear – Power Supplies	AC Power	AC power presence	Constant green	Not illuminated: AC failure
	DC Power (Tri-color LED)	<ul style="list-style-type: none"> DC power present Power supply temperature Fault Status 	Constant green	<ul style="list-style-type: none"> Not illuminated: DC failure Amber: power supply is over temperature Red: power supply is in a fault state
Rear – CPU	Status	System status	<ul style="list-style-type: none"> Solid amber during boot load (10 sec) Solid green during app load (1-4 minutes, depending on system configuration) Flashing green when ready 	Blinking red/green: MCPU is in a fault state. Power cycle may recover; otherwise, contact technical support.
	LAN 100/1000 and ICS LAN <ul style="list-style-type: none"> L/A SPD 	<ul style="list-style-type: none"> Cables are connected and terminated correctly Receiving or transmitting LAN data packets 	<ul style="list-style-type: none"> Constant green Blinks yellow 	

* The system was in the process of upgrading the last time it was powered down; wait for upgrade to finish (see page 240).

IMPORTANT: If the indicator LEDs do not respond with a normal display as stated in the table above, check power connections, before contacting technical support (see page 65).

Redundant Power Supply (RPS)

Every Enova DGX 800/1600/3200 enclosure ships with two mutually-redundant (hot-swappable) power supplies; every Enova DGX 6400 enclosure ships with four.

- **Enova DGX 800/1600/3200** – Power indicator on the front of the enclosure illuminates constant red if a problem occurs with one or more power supplies.
- **Enova DGX 6400** – Power indicator on the front of the enclosure illuminates constant red if a problem occurs with one power supply and flashing red if two or three power supplies experience problems.

IMPORTANT: *Enova DGX 6400 only – If two or more power supplies are not receiving power, the CPU and the control panel will continue to operate. However, input and output boards will become inoperable and the system will not send or receive signals until at least three power supplies resume functional status.*

Check the AC and DC LED indicators on the left of each power receptacle to determine if a power supply is not working. For additional LED information, see above.

IMPORTANT: *A failed power supply should be replaced as soon as possible to maintain the system's power redundancy. For replacement information, contact technical support.*

Power Supply Troubleshooting

- If a power supply's AC and DC power indicator LEDs are not illuminated: Check to be sure the power cord is completely plugged into the enclosure and the power source.
- If a power supply's DC LED illuminates amber or red, contact technical support.

CAUTION: *Do not remove a failed power supply until the replacement is ready to install, unless directed to do so by technical support.*

CPU/Control Board (all DGX 100 Series Enclosures)

Overview

The CPU/Control board is identical for all DGX 100 Series Enclosures (FIG. 32). It is located on the left rear of the enclosure, directly below the input connectors on the Enova DGX 800/1600/3200, and directly below the left bank of output connectors on the Enova DGX 6400.

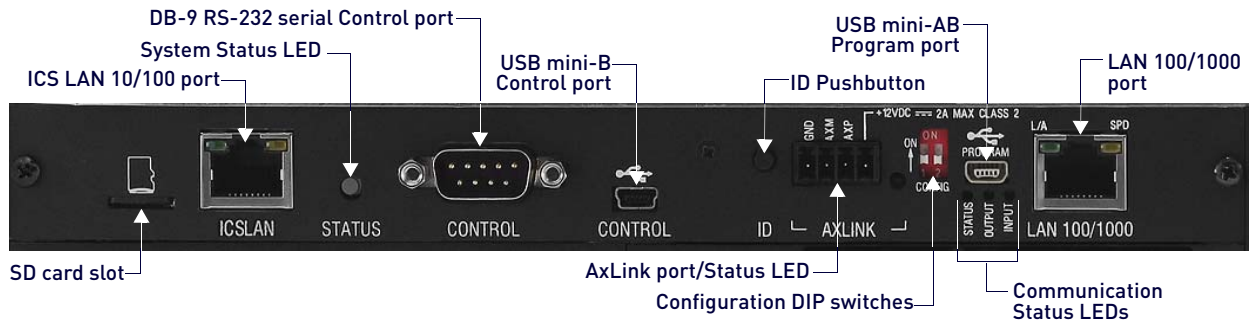

FIG. 32 DGX 6400 - Rear Panel Components

CPU/Control Board Components	
SD card slot	Ships with an installed MicroSD memory card for future functionality.
ICS LAN 10/100 port	RJ-45 connector for communication with endpoint devices in auto-setup configuration over ICS LAN (private network). NOTE: Do not use for a TCP/IP connection or linking of enclosures.
System Status LED	Indicates system status (see page 283)
Control port	DB-9, RS-232 connector for attaching an external serial control device (see page 313).
Control port	USB mini-B connector for attaching an external control device (see page 313).
NOTE: The Control ports provide direct control of matrix switcher processing. They do not work on the same layer of control as the integrated NetLinx NX Master, which uses the LAN 100/1000 and Program ports.	
ID Pushbutton	For selecting static IP or DHCP, resetting the factory defaults, and restoring the factory firmware image (see page 60).
AxLink port/Status LED	4-pin captive wire connector for supporting AMX AxLink devices. The LED to the right of the AxLink port indicates AxLink data activity (see page 59).
Config DIP switch	2-position toggles for setting the Program Run Disable (PRD) mode (see page 61).
Program port	USB mini-AB connector for establishing a connection from the integrated NetLinx NX Master to the PC's COM port (see page 58).
Communication Status LEDs	Status, Output, and Input LEDs indicate system communication status and indicating when data is sent and received (for modes and blink patterns, see page 58)
LAN 100/1000 port	Ethernet RJ-45 port for connecting from the integrated NetLinx NX Master to a public LAN (see page 56) for all runtime control, NetLinx programming, etc.

NOTE: For an overview of integrated NetLinx NX Master functionality, see page 28.

Control Panel

Overview

The Control Panel on the front of all Enova DGX enclosures is used to control system switches and system attributes. All Enova DGX 100 Series Switcher Control Panels function the same, but have input and output key support respective to their size.

The Control Panel has an LCD, a Function key, Control Dial, Select key, Cancel key, Take key, Input and Output keys, and Power Indicator (FIG. 33):

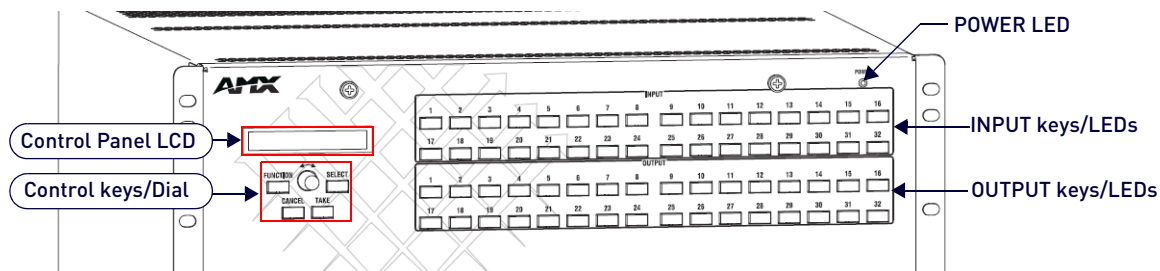

FIG. 33 DGX Enclosures Control Panel (DGX 3200 shown)

The Control Dial and Select key work together for scrolling through the menu items displayed on the LCD to place the system into various modes (the types of operations, e.g., Change Mode to execute switches) or to access lists for control operations.

Once in the desired mode, use the Input and Output keys to select values and the Take key to execute the operations (some modes require using the Control Dial and/or Select key to select values).

NOTE: One of the most used functions of the Control Panel is quickly retrieving the IP address through the Control Panel's LCD menu (Function/Setup Options/Master Info/IP Address).

Control Keys and Dial

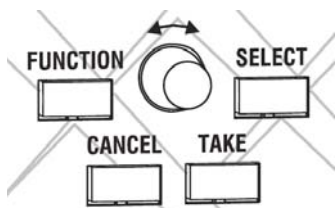

FIG. 34 Control keys and Dial

Control Keys and Dial Functions	
FUNCTION Key	The Function key accesses the Function menu on the LCD. As the Control Dial is scrolled, the menu displays the various command options, e.g., Change and Status. The Function key can be pressed at any time to return the display to the Function menu. For an overview of the menu options, see page 68.
SELECT Key	The Select key enters a selection. In addition, the Select key can be used to execute global presets. However, the Select key <i>cannot</i> execute or disconnect switches. Pressing the Take key executes or disconnects switches.
CANCEL Key	Pressing the Cancel key clears an incomplete operation and returns the display to the beginning of a sub-menu or list. The Cancel key <i>cannot</i> undo a completed operation, e.g., an operation followed by the pressing of the Take key or an audio adjustment made with the Control Dial. Note: If the Cancel key flashes, an error has occurred; a flashing Cancel key must be pressed before continuing.
TAKE Key	The Take key functions much like the Enter key on a computer keyboard. Pressing the Take key instructs the system to execute or disconnect a switch. Prior to pressing the Take key, the individual operation component(s) are selected by pressing the appropriate key(s).
Control Dial	The Control Dial scrolls through the menu options and adjusts values, such as volume. The Control Dial is used in conjunction with the Select key to choose the commands and values on the LCD and change virtual matrices between standard virtual matrix configurations and any custom virtual matrices.

Input and Output Keys

Input and Output keys correspond to the input and output connections on the rear of the enclosure (FIG. 35). These keys are used to select the inputs and outputs for routing source signals to destination devices, as well as for status and audio operations. Input keys are also used for locking and unlocking the Control Panel.

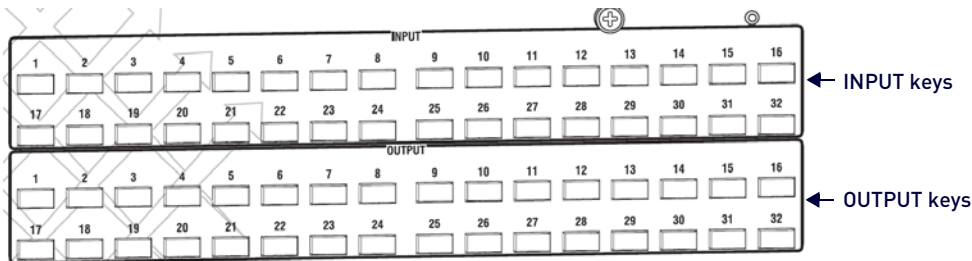

FIG. 35 Input and Output keys

When an Input or Output key is pressed, the channel name displays on the LCD. Hold the key down to display the name longer.

NOTE: Channel names that have been customized in the System Configuration interface (see page 127) will automatically display on the LCD when the Input or Output key is pressed. The channel name default is "Input Name" or "Output Name." The control panel's LCD is limited to 20 characters and will truncate any longer names that are pulled from the System Configuration interface.

The color of the Input and Output keys indicate availability or selection:

Input and Output Keys - Color Codes	
Blue	Indicates the input or output is available for selection as part of the current operation.
White or flashing white	Indicates an input or output has been selected and that additional action is required to complete the operation. When verifying Status, the key corresponding to the selected input or output is white; a key(s) for the input or outputs that are connected to the selected key turn white. When a key is flashing white, it cannot be deselected and does not display label information on the LCD when pressed. Select another key or press the Cancel key to deselect.
Non-illuminated	Indicates the input or output is not available for the current operation, e.g., if the enclosure's configuration size is not a full 32x32, some keys are always unavailable (never illuminated) because they do not have a corresponding connector on the rear.

When an Input or Output key is pressed, the LCD displays the channel name. Hold the key down to display the name longer. Return to the Function menu at any time by pressing the Function key.

When in Change Mode, available keys will be illuminated in blue and any unavailable ones will not be illuminated. The first blue key selected flashes white and the next key(s) selected turns white. You can toggle the non-flashing white keys between the selected (white) and deselected (blue) state before pressing the Take key.

FIG. 36 shows various keys states while in Change Mode:

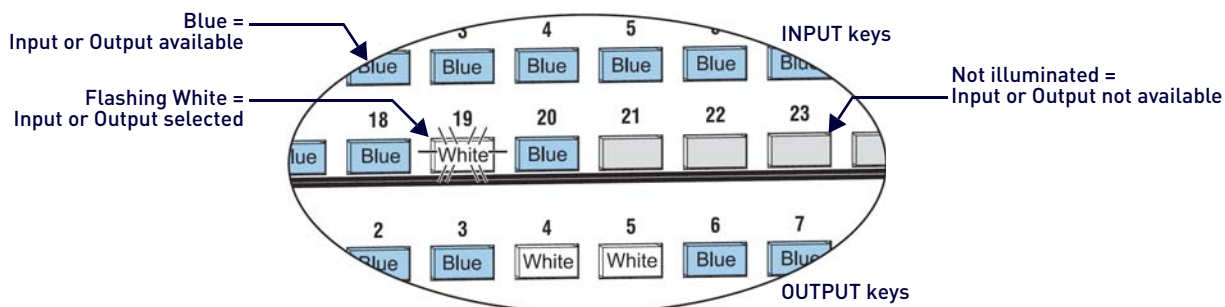

FIG. 36 Example of Key States During Change Mode

- Input key 19 is flashing white, indicating that input was selected first.
- Outputs keys 4 and 5 are white, indicating that those outputs have also been selected (and can be deselected).
- The switch from Input 19 to Outputs 4 and 5 will be executed when the Take key is pressed.
- Note that keys 21 through 24 in the second row of inputs are not available (i.e., a board has not been installed for these inputs).

Function Menus and Modes

The Function menu and its sub-menus access the modes and functions used to control the system. The modes are Change, Virtual Matrix, Status, Disconnect, Setup Options, Lock Panel, Adjust Audio, Global Preset, and Master Info. While in a mode, the same command can be repeated, without having to return to the Function menu to re-select the mode.

NOTE: *Adjust Audio Mode is functional only when Audio Switching Boards (ASB or ASB-DAN) are in the system. When no Audio Switching Boards are present, any commands for Adjust Audio are ignored.*

Use the Control Dial and Select key to navigate the Function menu, and sub-menus. The Function menu and the sub-menus are loop menus, which means that each menu returns to its first item after you scroll past its last item. The Function menu and its sub-menus access the following modes and functions:

Function Menu and Sub-menus	
Change	This selection places the system in Change Mode. The Control Panel <i>must</i> be in Change Mode to execute switches. While in Change Mode, select the Input and Output(s) keys followed by the Take key to execute switches (see top of the page).
Virtual Matrix	This selection accesses the virtual matrices designated for the system in the configuration file (VM 0, VM 1, and VM 2). The Virtual Matrix Mode can be selected to change the virtual matrix currently used to execute operations. Refer to the <i>Changing the Virtual Matrix</i> section on page 71 for details.
Status	This selection places the system in Status Mode. Status Mode is used to confirm signal routing or routing to multiple outputs without risk of accidentally executing a switch. Refer to the <i>Verifying Signal Status</i> section on page 72 for details.
Disconnect	This selection places the system in Disconnect Mode. While in Disconnect Mode, select the Input or Output key(s) followed by the Take key to disconnect switches. Note: <i>While in Disconnect Mode, the Control Panel does not indicate the current routing of selected inputs or outputs.</i> Refer to the <i>Disconnecting Switches</i> section on page 71 for details.
Setup Options	This selection accesses the Setup Options sub-menu to check the software version, view information regarding the integrated Master, change the default virtual matrix, reload the configuration file (when directed to do so by technical support), and change the password. Refer to the <i>Setup Options</i> section on page 76 for details.
Lock Panel	Selecting Lock Panel places the Control Panel in Lock Mode at which time the password is entered to lock the panel. Locking the panel prohibits access to the system and can prevent accidental switching. Refer to the <i>Locking and Unlocking</i> section on page 74 for details.
Adjust Audio	Selecting Adjust Audio accesses the Adjust Audio sub-menu. From this menu you can place the panel in Output Volume Mode, Mute/Unmute Mode, or Input Gain Mode. Refer to the <i>Adjusting Audio (Systems with Audio Switching Boards Only)</i> section on page 74 for details.
Global Preset	Selecting Global Preset accesses the Global Preset sub-menu to execute global presets or define global presets. Refer to the <i>Defining and Executing Global Presets</i> section on page 72 for details.

NOTE: *A clear label with white lettering that shows the entire LCD Function menu is included in the Control Panel Label Kit shipped with the system.*

Enova DGX Control Panel - Basic Tasks

- **Choosing a mode, sub-menu, or list:** press the Function key to access the Function menu. Use the Control Dial and Select key to choose the desired mode, sub-menu, list, or list item.
- **Selecting inputs or outputs:** press the corresponding Input or Output key. Selected keys will change color or flash, depending on the routing state.
- **Selecting values for fields:** use the Control Dial and Select key (e.g., virtual matrices, volume, presets).
- **Executing a command:** press the Take key.

Labeling Input and Output Keys

Each Enova DGX Switcher ships with a kit for custom labeling. To order additional kits, contact your AMX representative. The Control Panel Label Kit (KA1056-01) includes:

- **Perforated card stock sheets** – Print, separate labels, and slide into holders.
- **Label holders** – Attach to the front panel above each row of Input and Output keys.
- **LCD Function menu label** – Shows entire LCD menu structure (see Note on previous page).

The label template (.xlt template formatted in Microsoft Excel) for labeling the input and output keys is available at www.amx.com (FIG. 37):

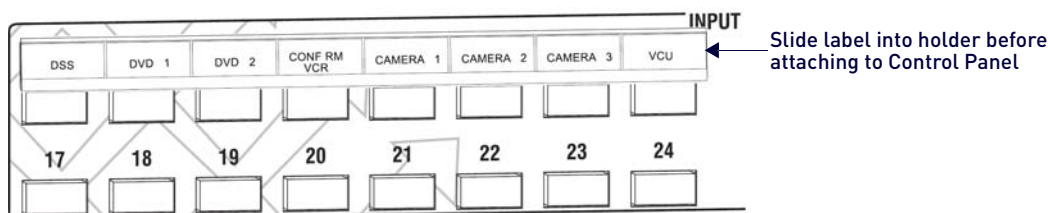

FIG. 37 Customized Input and Output Labels

TIP: *When the labels are ready to print, we recommend printing a sample on plain paper first.*

Creating and Installing Custom Labels for Input and Output Keys

1. At www.amx.com, search for Control Panel Label Form Template.
2. Under **AutoPatch Tools** in the right-hand column, click on **Control Panel Label Form Template**.

3. Type the labels in the preformatted cells on the template according to the instructions in the template (if desired, use standard Excel editing tools to alter font size, spacing, color, etc.). *Do not modify the cell size.*
4. Save the file for future use (recommended).
5. Print the labels on the perforated sheets provided, using any standard laser printer.
6. Trim off the excess label insert material where indicated.
7. Separate the label strips at their perforations (bend back and forth first).
8. Slide the first label strip into a plastic label holder (position with open edge of holder up).
9. Peel the adhesive backing off the label holder and press the holder firmly onto the Control Panel above the appropriate Input or Output keys. The silk screened labels on the front panel will aid in label holder alignment.
10. Repeat Steps 8 and 9 for the remaining labels.

Executing Switches

A switch is an active connection between an input (source) device and one or more output (destination) devices. The signals routed in a switching operation are individual signals or groups of individual signals coming through the connectors on the rear of an enclosure. You can execute switches from the Control Panel using the steps below or by defining and executing a global preset (see page 72).

The LCD displays the VM (default VM 0) in the upper-right corner; this is the virtual matrix that operations are currently being executed on. Switches are executed on the default virtual matrix unless otherwise specified. When specifying a virtual matrix, be sure it includes the signal(s) you want to route.

Virtual matrix definitions reside in the configuration information in an enclosure's CPU. If you need to change the virtual matrix that switches are being executed on, see "Changing the Virtual Matrix" on page 71. If you decide to change the default virtual matrix, see page 76 for "Setup Options."

In an execute switch command either an input or an output may be selected first. To switch to multiple outputs, the Input key **must** be selected first. Use the Control Panel to select and deselect Input and Output keys to modify the switch as long as the keys are not flashing. Once satisfied with the switch selections, press the Take key to execute it. (Or, if not satisfied with the selections, press the Cancel key and start over.)

For new installations, we recommend executing a test switch to verify the system is working correctly before attaching all inputs and outputs. To execute a test switch, attach the first input (source) and first output (destination) and then complete the directions below. For more information on test switches, see page 70.

Executing a Test Switch

The directions below switch Input 1 to Output 2 on VM 0.

NOTE: Before executing the test switch below, use the directions on page 71 to disconnect the factory default switch (i.e., disconnect Input 1 which is connected to all outputs on Virtual Matrix 1 when it leaves the factory).

1. Press the **Function** key. The *Function* menu appears.

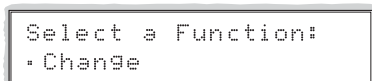

```

Select a Function:
- Change
  
```

2. Press the **Select** key to choose **Change**. The system is in Change Mode (the available Input and Output keys turn blue).

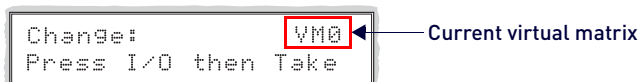

```

Change:
Press I/O then Take
  
```

← **VM0** — Current virtual matrix

3. Press **Input key 1**. Input key 1 flashes indicating that it is ready to switch (any outputs currently connected to a selected input will turn white).
4. Press **Output key 2**. Output key 2 illuminates indicating that it is ready to accept the switch.
5. Press the **Take** key. Input 1 switches to Output 2, and the keys turn blue. The panel remains in Change Mode until the Function key is pressed.
6. Press **Input key 1** again to toggle it off, and Press the **Take** key to disconnect the test switch.

Controlling Switches on Systems with Audio Switching Boards

IMPORTANT: The control panel does not have direct control of the audio signal on the Audio Switching Boards (ASB or ASB-DAN). The analog audio signal from the Audio Switching Board must first replace the embedded audio on the HDMI signal via a SEND_COMMAND (see page 225). Only then can the audio signal from the Audio Switching Board be switched with the video or routed independently from the video as a breakaway.

Control of video and audio switching on systems with Audio Switching Boards (ASB or ASB-DAN) works as follows:

- To switch digital video with its embedded audio, use either VM 0 (All) or VM 1 (Video).
- To switch the embedded audio separately from the digital video (as a breakaway audio signal), use VM 2. When switching on VM 0 or VM 1, the embedded audio is still present.

The embedded audio can also be analog audio from the Audio Switching Boards which has been used to replace the embedded audio via a SEND_COMMAND (see page 225).

Complete audio switching functionality is available via the System Configuration interface (see page 184) or via SEND_COMMANDs (see page 225).

Changing the Virtual Matrix

Enova DGX Switchers support three virtual matrices for switching signals:

- VM 0 Default (Audio follow Video)
- VM 1 Video Breakaway
- VM 2 Audio Breakaway

VM 0 is the factory default; we do not recommend changing the established VM numbers. If you create a custom configuration, you will need to change the virtual matrix on the Control Panel to execute switches (or other operations) using the custom virtual matrix.

IMPORTANT: *When audio is embedded on HDMI, the audio switches on the same VM as the video (VM 0 or VM 1). If the system contains Audio Switching Boards (ASB or ASB-DAN), embedded audio can be switched independently on VM 2. If the system does not contain Audio Switching Boards, VM 2 is not functional.*

The directions below give steps to change from routing signals on VM 0 (Default) to routing on VM 1 (Video).

Changing the Virtual Matrix

1. Press the **Function** key. The Function menu appears.
2. Locate **Virtual Matrix** by scrolling with the Control Dial.

```
Select a Function:
- Virtual Matrix
```

3. Press the **Select** key. The V.Matrix list appears.

```
V. Matrix          VM0 ← Current virtual matrix
- 0: All
```

4. Scroll with the Control Dial to **1:Video**.

```
V. Matrix          VM0
- 1: Video
```

5. Press the **Select** key to enter your selection. The display returns to the top of the V.Matrix sub-menu. VM 1 becomes the new virtual matrix used for all operations.

```
V. Matrix          VM1 ← New virtual matrix
- 0: All
```

6. Press the **Function** key to return to the Function menu.

The system is ready to execute operations on VM 1. The system will remain on VM 1 for all operations until the virtual matrix is changed or the power is cycled (at which time the Control Panel will switch on the default virtual matrix).

NOTE: *To change the default virtual matrix, see the instructions on page 71.*

Disconnecting Switches

Disconnecting a switch deactivates the connection between an input (source) and one or more output (destination) devices. Disconnecting an input will disconnect all outputs currently receiving the input's signal. An output can only be connected to one input; therefore, disconnecting an output will only disconnect the connection between the output and the input that is routed to it. Inputs and outputs can be selected in the same disconnect command.

Disconnect inputs or outputs from the Control Panel using the steps below. If you need to change the virtual matrix, see "Changing the Virtual Matrix" on page 71.

NOTE: *When you put the panel in Disconnect Mode, the available keys will be illuminated in blue and any unavailable ones will not be illuminated. When you select a blue key, it turns white. You can toggle the keys between the selected (white) and deselected (blue) state before pressing the Take key.*

Once the Control Panel is in Disconnect Mode, inputs and outputs can be selected and deselected by pressing the corresponding Input and Output keys. The disconnect command is not executed until the Take key is pressed. Pressing the Cancel key clears an incomplete disconnect command and returns the display to the beginning of the sub-menu.

While in Disconnect Mode, the Control Panel *will not* show current routing for the inputs and outputs that are selected.

CAUTION: *Disconnecting an input disconnects all outputs receiving that source signal even if a specific output(s) is selected at the same time.*

The following example disconnects Inputs 1 and 3 and all outputs connected to them as well as Output 9.

Disconnecting Inputs and Outputs

1. Press the **Function** key. The Function menu appears.

```
Select a Function:
- Change
```

2. Locate **Disconnect** by scrolling with the Control Dial.

```
Select a Function:
- Disconnect
```

3. Press the **Select** key. The system is in Disconnect Mode. All available Input and Output keys turn blue.
4. Press Input keys 1 and 3 and Output key 9. The keys turn white indicating that they are selected.

```
Disconnect:      VM0
Press I/O then Take
```

5. Press the **Take** key. Inputs 1 and 3 (and all outputs connected to them) and Output 9 are disconnected as soon as the Take key is pressed and the keys turn blue.
6. Make additional disconnects.
 - or -
 - Press the **Function** key to return to the Function menu.

Verifying Signal Status

The status of inputs or outputs can be checked using the Enova DGX Control Panel. Signal status can be verified to confirm that a switch has executed properly or to confirm correct routing to multiple outputs (destinations). Verifying an input will illuminate all outputs currently receiving the input's signal. An output can only be connected to one input (source); therefore, verifying the status of an output will illuminate only the one input that is currently routed to it. Once the Control Panel is in Status Mode, inputs and outputs can be selected by pressing the corresponding Input and Output keys without changing the routing state. The panel stays in Status Mode until the Function key is pressed.

To verify signal status on a different virtual matrix, see "Changing the Virtual Matrix" on page 71.

1. Press the **Function** key. The Function menu appears.

```
Select a Function:
- Change
```

2. Locate **Status** by scrolling with the Control Dial.

```
Select a Function:
- Status
```

3. Press the **Select** key. The system is in Status Mode (all available Input and Output keys turn blue).

```
Status:          VM0
Press I/O Key
```

4. Press the Input key that corresponds to the input you want to check. The selected Input key turns white, and any Output keys receiving the input signal also turn white.
 - or -
 - Press the Output key that corresponds to the output you want to check. The selected Output key turns white, and if an Input key routed to it, that key also turns white.
5. Select another signal to verify.
 - or -
 - Press the Function key to return to the Function menu.

Defining and Executing Global Presets

Global presets are predefined sets of switches that can easily be executed at one time. Each global preset is a snapshot of the system's routing state and output volume settings at a particular time which can be recalled at a later time. The system must be routed to the desired state before defining a global preset.

Global presets can be defined or recalled using either the Control Panel or BCS commands interchangeably.

The Control Panel on the Enova DGX Switcher supports up to 64 global presets. Because all 64 potential global preset numbers are displayed in the Global Preset sub-menu, be aware that nothing indicates which of the numbers have been assigned a routing state. A system state can be restored at any time by selecting the assigned global preset number.

Depending on whether or not the system includes Audio Switching Boards, global presets operate in one of two ways in Enova DGX 100 Series Switchers:

Systems without Audio Switching Boards (ASB or ASB-DAN)

A global preset number can be assigned to a routing state during runtime and stored by the system, allowing you to replicate an entire system's routing state.

NOTE: *The global preset will not affect the injection/extraction setting on any channel of any AIE Board.*

Systems with Audio Switching Boards (ASB or ASB-DAN)

A global preset number can be assigned to a routing state during runtime and stored by the system, allowing you to replicate a subset of the system state. The system routing state includes all signal routings and audio settings for Mute/Unmute and Output Volume; however, it excludes any down-mix switching routes. Global presets cannot capture Digital Signal Processing settings.

NOTE: *If a backup of a given entire system state is required when Audio Switching Boards are in the system (including Digital Signal Processing settings), the System Configuration interface's Switcher-Setup-Save function can save all of the system's configuration values in a file that can be loaded back to the Switcher when needed (see page 133).*

CAUTION: *Keep track of the number and the system state routing used for each global preset. If a previously used number is assigned to another system state (using either the Control Panel or BCS commands), the former state will be automatically overwritten.*

The instructions below define an example Global Preset 3, and the instructions at the bottom of the page are used to execute a predefined Global Preset 3.

IMPORTANT: *Wait approximately ten seconds for the system to store the global preset setting before executing another operation.*

Defining a Global Preset

1. Route the system to the desired state.
2. Press the **Function** key. The Function menu appears.
3. Locate **Global Preset** by scrolling with the Control Dial.

```
Select a Function:
· Global Preset
```

4. Press the **Select** key. The Global Preset sub-menu appears.

```
Global Preset:
· Define Global
```

5. Scroll with the Control Dial to **Define Global**. Press the **Select** key. The Define Global list appears.

```
Define Global:
· 1:Global Preset 1
```

6. Scroll with the Control Dial until **Global Preset 3** appears.

```
Define Global:
· 3:Global Preset 3
```

7. Press either the **Select** key or the **Take** key.
8. Wait approximately ten seconds for the system to store the global preset setting.
The current routing state can now be recalled as Global Preset 3, and the system returns to the Global Preset sub-menu.
9. Press the **Function** key to return to the Function menu.

Executing a Global Preset

1. Press the **Function** key. The Function menu appears.
2. Locate **Global Preset** by scrolling with the Control Dial.
3. Press the **Select** key. Execute Global appears.
4. Press the **Select** key. The Execute Global Preset list appears.

```
Execute Global:
· 1:Global Preset 1
```

5. Scroll with the Control Dial until **Global Preset 3** appears.

```
Execute Global:
· 3:Global Preset 3
```

6. Press either the **Select** key or the **Take** key.

Global Preset 3 is executed. The system now reflects the routing state that it was in when Global Preset 3 was defined. The system returns to the Global Preset sub-menu.

7. Press the **Function** key to return to the Function menu.

NOTE: *Status is not invalidated by global presets.*

Locking and Unlocking

Locking the Enova DGX Control Panel prohibits access to the system and can prevent accidental switching. While the panel is locked, BCS commands still work; however, they cannot be used to unlock the panel. The panel remains locked if the power is cycled.

The password used to lock and unlock the panel consists of a sequence of five input keys. The factory default password is the first five Input keys (1-2-3-4-5). A new password can be set using any combination of five keys from Input 1 through Input 8 (for instructions, see page 79).

CAUTION: *Record all passwords in a secure place; the Control Panel cannot be used to retrieve a lost password.*

If the password is lost while the system is locked, contact technical support.

Locking the Control Panel

If you enter the wrong password while attempting to lock the Control Panel, the LCD displays "Invalid Password" and the Cancel key flashes. Press the Cancel key to clear the error and enter the correct password.

NOTE: *For security purposes, the Input keys do not turn white when pressed while locking and unlocking the panel.*

1. Press the **Function** key. The Function menu appears.

```
Select a Function:
• Change
```

2. Locate **Lock Panel** by scrolling with the Control Dial.

```
Select a Function:
• Lock Panel
```

3. Press the **Select** key. The system is in Lock Mode (Input keys 1 through 8 turn blue).
4. Press the Input keys in the following order: 1, 2, 3, 4, 5 (default password).

```
Lock Panel:
Password=**_ _ _
```

5. The panel is locked, and all Input and Output keys turn off.

```
PANEL IS LOCKED
Press any Key
```

Unlocking the Control Panel

When the panel is locked and you press any key, the Unlock Panel Screen appears. You have ten (10) seconds to enter the password or the Control Panel remains locked. If you wait longer than 10 seconds, press any key again before entering the password.

NOTE: *If you enter the wrong password while attempting to unlock the Control Panel, an invalid password message appears and the Cancel key flashes. Press the Cancel key to clear the error and enter the correct password.*

1. Press any key. The **Unlock Panel** screen appears (Input keys 1 through 8 turn blue).

NOTE: *You must enter the password within ten (10) seconds.*

```
Unlock Panel:
Password=**_ _ _
```

2. Press the Input keys in the following order: 1, 2, 3, 4, 5 (default password).
3. The panel unlocks and returns to the Function menu.

Adjusting Audio (Systems with Audio Switching Boards Only)

IMPORTANT: *This section on Adjusting Audio does not apply to Audio Insert/Extract Boards.*

If the Enova DGX System contains Audio Switching Boards (ASB or ASB-DAN), the control panel supports three Audio Modes for adjusting the embedded audio: Output Volume, Mute/Unmute, and Input Gain. If Audio Switching Boards are not contained within the enclosure, the Adjust Audio control panel option will be nonfunctional.

IMPORTANT: *The Control Panel cannot directly access the audio on an Audio Switching Board. The Control Panel can only adjust the audio from an Audio Switching Board after it has been embedded on a video board.*

NOTE: *Complete audio signal processing functionality is available via the System Configuration interface (see page 184) or via SEND_COMMANDs (see page 225).*

When the panel is placed in any of the Audio Modes, available keys will be blue and any unavailable ones will not be illuminated. When you select a blue key, it turns white indicating that it is ready for the audio adjustment.

Audio Adjustments on the Control Panel

- May be made at any time during normal operation
- Are made in real time as the Control Dial is turned
- Do not require pressing the Take key
- Remain in effect until changed
- Can be made on any VM that contains audio
- Affect *only* embedded audio on the digital signals (the Control Panel cannot access the Audio Switching Boards' audio only inputs and outputs)

Adjusting Volume

The Adjust Volume Screen displays the current volume setting and the range available for the specific audio output signal that has been selected for adjustment. For more information on audio signals and specifications, see "Audio Switching Boards" on page 164. When audio is adjusted for an output signal switching on a VM containing audio, the adjustment remains in effect for that destination when it is switched on any other VM containing audio.

1. Route the source (input) to the destination (output) to be adjusted (on any VM which includes the audio).

NOTE: *Audio adjustments can be made without routing the switch.*

2. Press the **Function** key. The Function menu appears.

```
Select a Function:
· Change
```

3. Locate **Adjust Audio** by scrolling with the Control Dial.

```
Select a Function:
· Adjust Audio
```

4. Press the **Select** key. The Adjust Audio sub-menu appears.

```
Adjust Audio:
· Output Volume
```

5. Press the **Select** key again to choose **Output Volume**. The panel is in Output Volume Mode (all Input keys are turned off, and the available Output keys turn blue).

```
Volume: VM2 ← Current Routing Level
Press Output & Dial
```

6. Press the **Output** key that corresponds to the output to be adjusted. The Adjust Volume Screen appears, displaying the volume range of the audio signal and the current volume setting for the selected output.

```
|||||-----
-100dB (-55dB) 0dB ← Current Volume Setting
```

7. Adjust the volume by scrolling with the Control Dial. The volume audibly adjusts as you scroll the Control Dial.
8. Select another output to adjust.

- or -

press the **Cancel** key to return to the Adjust Audio sub-menu. The Cancel key does not undo the audio adjustments.

- or -

press the **Function** key to return to the Function menu.

NOTE: *If the selected output is muted, "Muted" displays as the current setting . Turning the Control Dial will unmute a muted output and adjust the Volume.*

```
-----
-100dB (MUTED) 0dB
```

Muting and Unmuting Outputs

NOTE: *The mute/unmute option applies to output volume only and is not available for input gain.*

1. Press the **Function** key. The Function menu appears.
2. Locate **Adjust Audio** by scrolling with the Control Dial.
3. Press the **Select** key to enter the selection. The Adjust Audio sub-menu appears.
4. Scroll the Control Dial to **Mute/Unmute**.

```
Adjust Audio:
· Mute/Unmute
```

- Press the **Select** key. The system is in Mute Mode (all Input keys are turned off, and the available Output keys turn blue), and any muted Output keys turn white.

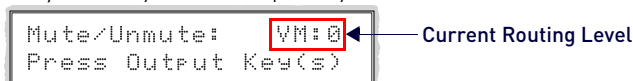

- Press the **Output** key that corresponds to the output to be muted. The output is muted, and the Output key turns white.
- Select another output to mute.
 - or -
 - press the **Cancel** key to return to the Adjust Audio sub-menu. The Cancel key does not undo the audio adjustments.
 - or -
 - press the **Function** key to return to the Function menu.

Unmuting an Output While In Mute Mode

Press the muted (white) **Output** key. The output is unmuted, and the Output key turns blue.

Adjusting Input Gain

The purpose of "Input Gain Control" is to allow input (source) signals of varying amplitudes to be equalized before they are routed and the volume is adjusted. Equalizing input signals provides a consistent reference for volume adjustments and eliminates jumps when routing between different inputs.

Typical uses for input gain (the nominal level of the signal from the source device) include switching consumer and professional grade audio equipment (whose levels can vary noticeably) in the same matrix switcher. Input gain adjustment is also used for equalizing amplitudes between balanced and unbalanced source inputs.

The Adjust Input Gain Screen displays the current gain setting and the range available for the specific audio input signal that has been selected for adjustment. For more information on audio signals and specifications, see the "Audio Switching Boards" chapter on page 164.

CAUTION: We strongly recommend that input gain adjustments be made only by a qualified dealer or installer.

The following steps tell how to adjust input gain as part of the process of equalizing input levels.

- Route the source (input) to be adjusted to the destination (output); see page 70.

NOTE: Audio adjustments can be made without routing the switch.

- Press the **Function** key. The Function menu appears.
- Locate **Adjust Audio** by scrolling with the Control Dial.
- Press the **Select** key to enter the selection. The Adjust Audio sub-menu appears.
- Scroll the Control Dial to **Input Gain**.

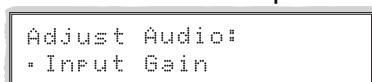

- Press the **Select** key. The system is in Input Gain Mode (the available Input keys turn blue, and all Output keys are turned off).

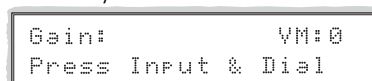

- Press the Input key that corresponds to the source that was routed in Step 1. The Adjust Input Gain Screen appears, displaying the gain range of the audio signal and the current gain setting.

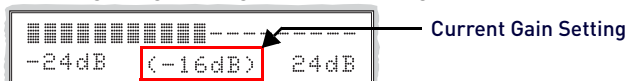

- Adjust the input gain by scrolling with the Control Dial. The gain audibly adjusts as you scroll.

NOTE: Repeat Steps 1 through 8 as necessary for additional sources (inputs) that will be routed to the same destination (output).

Setup Options

The following options are available under the Setup Options sub-menu:

- **Software Version** – to display software version information for the Control Panel
- **Master Info** – to display information for the integrated Master - useful for quickly finding the system's IP address (Function/Setup Options/Master Info/IP Address).
- **Default VM** – to change the factory default virtual matrix
- **Reload Config** – is not used in normal operations; use only when directed to do so by technical support
- **Change Password** – to change the password from the factory default

Software Version

The Software Version Screen provides the following information:

- **Driver** – Control Panel's firmware version
- **Built** – date the Control Panel's software was built
- **Host** – software version of the initial operating system (IOS) for the Control Panel
- **XNet ID** – Control Panel's XNet device number
- **FP Link baud 9600** – indicates the Control Panel (FP = Front Panel) and the baud rate

Use the following steps to check the software version information for the Control Panel.

Checking Software Version Information

1. Press the **Function** key. The Function menu appears.

```
Select a Function:
· Change
```

2. Locate **Setup Options** by scrolling with the Control Dial.

```
Select a Function:
· Setup Options
```

3. Press the **Select** key. The Setup Options sub-menu appears. Locate **Software Version** by scrolling with the Control Dial.

```
Setup Options:
· Software Version
```

4. Press the **Select** key again to choose **Software Version**. The Software Version Screen appears.

```
Software Version:
· Driver: Va.b.c ← Version number
```

5. Scroll with the Control Dial to see additional Software Version information.
6. Press the **Cancel** key to return to the Setup Options sub-menu.
- or -
Press the **Function** key to return to the Function menu.

Master Info

NOTE: The enclosure must be connected to a network before its IP address will display. Also note that IPv6 addresses are truncated to fit the 20 character limit on the LCD.

The Master Info Screen provides the following information for the integrated Master:

- **System Number** – indicates the system number
- **Serial Number** – indicates the system's serial number
- **MAC Address** – indicates the system's MAC address
- **IP Address** – indicates the IP address*
- **IP Device Type** – indicates either DHCP or non-DHCP
- **Subnet** – indicates the Network setting for the subnet mask*
- **Gateway** – indicates the Network setting for the gateway
- **Host Name** – indicates the host name for the system
- **DNS Address** – indicates the DNS IP address for the system*
- **Master Version** – indicates the version of the integrated Master
- **Switcher Version** – indicates the version of the switcher
- **Controller Version** – indicates the version for the controller

Use the following steps to check information for the integrated Master.

Checking Integrated Master Info

1. Press the **Function** key. The Function menu appears.

```
Select a Function:
· Change
```

2. Locate **Setup Options** by scrolling with the Control Dial.

```
Select a Function:
· Setup Options
```

3. Press the **Select** key. The Setup Options sub-menu appears. Locate **Master Info** by scrolling with the Control Dial.

```
Setup Options:
· Master Info
```

4. Press the **Select** key again to choose **Master Info**. The Master Info Screen appears.

```
Master Info:
• System Number
```

5. Press the **Select** key again to choose **System Number**.
- or -
6. Scroll with the Control Dial to choose other Master Info information.
7. Press the **Cancel** key to return to the Setup Options sub-menu.
- or -
8. Press the **Function** key to return to the Function menu.

Default Virtual Matrix

The factory default virtual matrix for the Enova DGX Switcher is **VM 0**.

You have the option of changing the factory default virtual matrix for your system. When you choose a new default virtual matrix, the system will revert to that virtual matrix each time the system is powered up even if you changed the virtual matrix using the V.Matrix list during normal operation.

The power must be cycled before the default virtual matrix changes are implemented. If you want to immediately switch on the default matrix, either change the current virtual matrix (see page 71) or cycle the power.

The following example changes the default virtual matrix from VM 0 to VM 2, the audio matrix.

1. Press the **Function** key. The Function menu appears.

```
Select a Function:
• Change
```

2. Locate **Setup Options** by scrolling with the Control Dial.

```
Select a Function:
• Setup Options
```

3. Press the **Select** key. The Setup Options sub-menu appears.
4. Scroll to **Default VM**, and press the **Select** key. The Default VM list appears.

```
Default VM:      VM:0 ← Current Default Virtual Matrix
• 0: All
```

5. Scroll to 2:Audio.

```
Default VM:      VM:0
• 2: Audio
```

6. Press the **Select** key. The display returns to the top of the Setup Options sub-menu.
7. Cycle power to implement VM 2 as the default virtual matrix.
- or -

Change the virtual matrix (see page 71) to immediately execute operations on the new default virtual matrix without cycling power. The next time power is cycled, VM 2 will be implemented as the default virtual matrix.

Reload Config

The Reload Config option is not used in normal operations. Use this option only when directed to do so by technical support.

1. Press the **Function** key. The **Function** menu appears.

```
Select a Function:
• Change
```

2. Locate **Setup Options** by scrolling with the Control Dial.

```
Select a Function:
• Setup Options
```

3. Press the **Select** key. The Setup Options sub-menu appears.
4. Scroll to Reload Config.

```
Setup Options:
• Reload Config
```

5. Press the **Select** key. The configuration file reloads to the Control Panel and the display returns to the top of the Setup Options sub-menu.
6. Press the **Function** key to return to the Function menu.

Setting the Password

The Enova DGX Control Panel's default password is "1 2 3 4 5" entered using the first five input keys. A new password can be set using any combination of five of the input keys 1 through 8 when the LCD displays "Enter New PWD" (Step 5 in the following procedure).

CAUTION: Record the new password in a secure place; the Control Panel cannot be used to retrieve a lost password.

If the password is lost while the system is locked, contact technical support.

1. Press the **Function** key. The Function menu appears.

```
Select a Function:
- Change
```

2. Locate **Setup Options** by scrolling with the Control Dial.

```
Select a Function:
- Setup Options
```

3. Press the **Select** key. The Setup Options sub-menu appears. Locate **Change Password** by scrolling with the Control Dial.

```
Setup Options:
- Change Password
```

4. Press the **Select** key. The LCD displays the prompt **Enter Current PWD**. Using the illuminated keys, input the current password.

The default password is 1 2 3 4 5.

```
Enter Current PWD:
Password=_____
```

5. The LCD displays the prompt **Enter New PWD**. Using any combination of the illuminated keys, input the new password. To change any entries, press the Cancel key – restarting the process – and reenter from the start.

```
Enter New PWD:
Password=_____
```

The LCD displays **Reenter New PWD**.

```
Reenter New PWD:
Password=_____
```

6. Re-enter the new password. If the re-entered password matches, the system accepts it as the new password, and the LCD displays **Password Reset**. Press the **Take** key and go to Step 7.

```
PASSWORD RESET
Press Take
```

- or -

If the re-entered password does not match, the LCD displays **Invalid Password**. Press the **Cancel** key to return to Enter New PWD screen and repeat Steps 5 and 6.

```
INVALID PASSWORD
Try Again
```

7. When the new password is successfully reset, press the **Cancel** key to return to the Setup Options sub-menu.

- or -

Press the **Function** key to return to the Function menu.

System Error Codes and Troubleshooting

This section provides an overview of the most common error codes that may appear on an Enova DGX Control Panel. The table below lists the error code, the name of the code, the meaning of the code, and some basic troubleshooting strategies (additional error code troubleshooting strategies are included on page 80).

The codes in the table are not intended to be comprehensive.

NOTE: If an error code appears that is not listed, note the specific number and contact technical support.

The first letter of the error code indicates the following:

- E = Error
- W = Warning
- A = Alarm* (requires immediate attention)
- I = Information*

For the following instructions, establish serial control and open a terminal emulation program, e.g., the terminal in NetLinX Studio (Tools/Terminal Session).

Enabling Error Code Reporting

1. Enter `$ERR=1!`
2. The system responds with a `v`.

NOTE: *If the power is cycled after this procedure, you will need to enable error code reporting again.*

Turning Error Code Reporting Off

1. Enter `$ERR=0!`

Most Common System Error Code			
Error Code	Name	Meaning	Basic Troubleshooting Strategies
EFF8002	Enclosure timeout error	The operation was not completed before the timer expired.	<ul style="list-style-type: none"> • Resend the command. • Check the power indicators. • Check that the command was sent using the correct virtual matrix.

Error Code Troubleshooting

Error codes can appear either on the Control Panel LCD or in a terminal emulation program, e.g., the terminal in NetLinX Studio (Tools/Terminal Session).

When you are using a Control Panel, one of the most common troubleshooting strategies is to resend the command to see if the error was simply a timeout error.

When you are using BCS commands, one common troubleshooting strategy is to enter the command again. Often the command has just been entered incorrectly (e.g., omitting an output in a Change command). In other cases, the command has specified a value that is not valid (e.g., a global preset number that does not correspond to a defined global preset).

If the error code persists after correcting and resending the command, contact technical support.

4K60 HDMI Input & Output Boards

Overview

This chapter pertains to Enova DGX 4K60 HDMI Input and Output Boards:

- 4K60 HDMI Input Board (FG1061-542)
- 4K60 HDMI Output Board (FG1061-552)

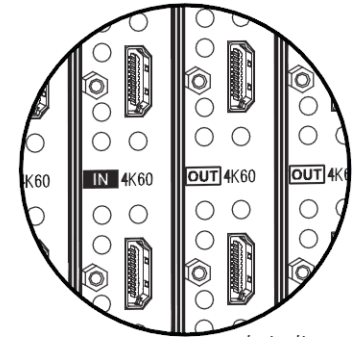
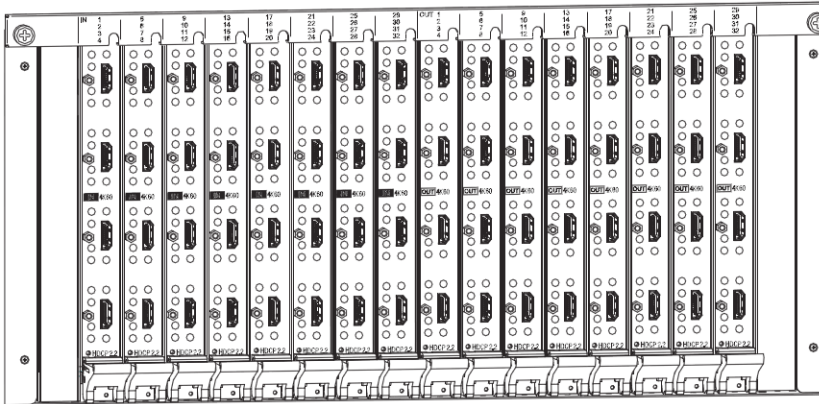

Enova DGX 4K60 HDMI Boards indicate "4K60" beside the IN or OUT label.

FIG. 38 Enova DGX 4K60 HDMI Input and Output Boards

Enova DGX Enclosure Support for 4K60 HDMI Input & Output Boards	
DGX 800	Holds up to four 4K60 HDMI Boards with four inputs or outputs per board. Each DGX 800 holds a maximum of two input and two output boards, accommodating connector configurations up to a maximum of 8x8, as well as three subsets (i.e., 4x4, 4x8, or 8x4).
DGX 1600	Holds up to eight 4K60 HDMI Boards with four inputs or outputs per board. Each DGX 1600 holds a maximum of four input and four output boards, accommodating connector configurations up to a maximum of 16x16, as well as subsets (e.g., 16x8 or 4x12).
DGX 3200	Holds up to sixteen 4K60 HDMI Boards with four inputs or outputs per board. Each DGX 3200 holds a maximum of eight input and eight output boards, accommodating connector configurations up to a maximum of 32x32, as well as subsets in increments of four (e.g., 12x20 or 24x8).
DGX 6400	Holds up to thirty-two 4K60 HDMI Boards with four inputs or outputs per board. Each DGX 6400 holds a maximum of sixteen input and sixteen output boards, accommodating connector configurations up to a maximum of 64x64, as well as subsets in increments of four (e.g., 12x48 or 52x8).

Signal Routing

DGX 4K60 HDMI Input Boards route signals to DGX 4K60 HDMI Output Boards or to any other type of Enova DGX Output Boards. 4K60 HDMI Output Boards can also accept signals from all of the other types of Enova DGX Boards.

IMPORTANT: *In contrast to other Enova DGX output points, DGX 4K60 HDMI Boards DO NOT utilize SmartScale[®] technology. Therefore, the use of DGX 4K60 HDMI Output Boards requires the use of 3rd party equipment with matching video capabilities. Refer to 3rd Party Equipment Requirements for DGX 4K60 HDMI Boards on page 82 for details.*

The HDMI connectors are designed to route high-resolution HDMI or DVI signals with or without HDCP (High-bandwidth Digital Content Protection). DVI signals must be single link DVI-D and require the use of a cable adapter. Destinations with DVI-I or single-link DVI-D connectors are supported.

DGX Board Compatibility

DGX 4K60 HDMI Input Boards work in conjunction with Audio Switching Boards (see page 164), Dante Audio Switching Boards (see page 150), or AIE Boards (see page 175).

NOTE: *AIE compatibility with DGX 4K60 HDMI Boards is limited to a single direction on each type of card (i.e. input cards only support extraction to AIE; Output cards only support insertion from AIE).*

Signals through 4K60 HDMI Boards in the DGX Switcher produce a quality image and provide support for the most flexible audio settings (because the HDMI ports are pre-loaded with the most common EDID settings). However, changes to EDID or scaling settings can be made via the System Configuration interface (see page 184).

4K60 Signal Routing

DGX 4K60 HDMI Input Boards route video from a source device through the Enova DGX to an output board (or via a DXLink Output Board to a DXLink Receiver). However, 4K60, 4K30, and 2K signals require substantially different hardware support.

For this reason a system Pre-Qualification feature has been added to the Enova DGX to allow signal routing to any output that is capable of Supporting the current video signal. Video signal path capabilities are based on the lowest common denominator of the signal path's components: In order to receive video at the destination device, the entire signal path (source device, input board, output board, receiver module, and destination device) must support the current video formats.

If 4K60 signals are passed to output boards or Receiver Modules that are not 4K60 capable, no signals will be shown on the destination device. To resolve compatibility issues, change the format from the source device or route the 4K60 formatted signal to a 4K60 capable output board. Refer to the *Video Signal Support Tiers* section below for a complete description.

NOTE: *PreQual is a signal Pre-Qualification feature that enforces signal path limitations and provides system-level indications via ICSP and the System Configuration Interface when a signal is blocked to an output port due to an incompatible source format."*

NOTE: *4K60 HDMI Boards requires at minimum a High Speed Category 2 cable, but we recommend "Certified Premium High Speed" HDMI cable for any 4K50/4K60 content.*

Video Signal Tiers Support

DGX 4K60 HDMI Boards handle the following three tiers of video signal components:

1. 2k – video formats up to HDMI 1.3a
2. 4k30 – 4k video formats that can be passed with HDMI 1.4 (up to HDCP 1.4 and HDCP 2.2 non-Premium)
3. 4k60 – 4k video formats that require HDMI 2.0 (up to HDCP 1.4 and HDCP 2.2 Premium or non-Premium)

NOTE: *For ease of initial installation the default EDID on the input cards is set to 4k30. This EDID will support 4K60 4:2:0 formats. If all of the 4K hardware in all of the desired paths support 4k60 4:4:4 or 4k60 4:2:2 formats, then you may want to change the EDID on the appropriate input channel(s) to a 4K60 EDID. See the System Configuration Interface section on page 184 for more information.*

3rd Party Equipment Requirements for DGX 4K60 HDMI Boards

- In contrast to other Enova DGX output points, DGX 4K60 HDMI Output Boards DO NOT utilize SmartScale technology. Therefore, the use of DGX 4K60 HDMI Output Boards requires the use of 3rd party equipment with matching video capabilities. Additionally, the installer must configure DGX 4K60 HDMI Boards to use the appropriate EDID and/or timing for target devices via the VIDIN_PREF_EDID (see page 216).
- DGX 4K60 HDMI Boards do not provide free-run video. Therefore, when a signal path is disconnected, DGX 4K60 HDMI Boards will lose the signal at the output point. In some cases (as with some projectors), this could cause some sinks to shutdown (which can take a long time for a projector).

Enova DGX 4K60 4:4:4 HDMI Input Board - Specifications

DGX-I-HDMI-4K60 (FG1061-542) - Specifications	
GENERAL	
Compatible AMX Products	Supported enclosures are Enova DGX 800, 1600, 3200 or 6400 Digital Media Enclosure built after June 1, 2016
Regulatory Compliance	See Enova DGX Digital Media Switcher Enclosure for regulatory compliance
HDMI w/HDCP	DESCRIPTION
Compatible Formats	HDMI 1.X, HDMI 2.0, HDCP 1.X, HDCP 2.2, DVI
Signal Type Support	HDMI, DisplayPort++ (Input Only) DVI-D (Single Link With HDMI Cable Adapter)
Video Data Rate (Max)	When used with compatible Enova DGX 100 series enclosures*: 18 Gbps (Max)
Video Pixel Clock (Max)	When used with compatible Enova DGX 100 series enclosures*: Up to 600 MHz
Progressive Resolution Support	When used with compatible Enova DGX 100 series enclosures*: 480p up to 4096x2160 @ 60Hz, 4:4:4
Interlaced Resolution Support	480i, 576i, 1080i NOTE: If input is interlaced, all scaled outputs will de-interlace video to a progressive resolution format. If non-scaled output board or if scaler is in Bypass mode, interlaced input will pass through unaltered.
4K Resolution Support (Max)	When used with compatible Enova DGX 100 series enclosures*: <ul style="list-style-type: none"> 3840x2160p @ 24/25/30/50/60 Hz, 4:4:4 4096x2160p @ 24/25/30/50/60 Hz, 4:4:4 3840x2160p @ 50/60 Hz, 4:2:0** 4096x2160p @ 50/60 Hz, 4:2:0** ** Supported by DX-RX-4K when in Bypass Scaling mode.
HDMI Cable Requirement	Premium Certified High Speed Cable Category 2, Recommended. HDMI High Speed Cable Category 2, Required
Input Equalization	Adaptive up to 21ft (7m). Cable distance support dependent on cable quality and signal format
Input Re-clocking (CDR)	Yes
Deep Color Support	24-bit, 30-bit***, 36-bit*** ***30-bit and 36 bit are only supported in CTA-861 formats. When switched to an output board or RX with Scaling support the Scaler must be in Bypass mode.
HDR Support	Yes, HDR10 with ST.2084 EOTF Output signal follows input format Note: Requires the use of HDR compatible output board such as 4K60 HDMI Output Board
Color Space Support	sRGB, BT.601, BT.709, BT.2020 RGB 4:4:4, YCbCr 4:4:4, 4:2:2, and 4:2:0 <ul style="list-style-type: none"> Input signal support for YCbCr 4:4:4 and 4:2:2, output color-space is converted to RGB 4:4:4 on scaled output Output signal follows input format on non-scaled output boards If 4:2:0 is switched to a 4K RX the RX scaler must be set to bypass
3D Format Support	<ul style="list-style-type: none"> Frame Packing 1080p up to 24 Hz Frame Packing 720P up to 50/60 Hz Frame Packing 1080i up to 50/60 Hz Top-Bottom 1080p up to 24 Hz Top-Bottom 720p up to 50/60 Hz Side-by-Side Half 1080i up to 50/60 Hz Note: If scale is present on corresponding output board or the RX it must be set to Bypass mode
Audio Format Support	<ul style="list-style-type: none"> Dolby Atmos, Dolby TrueHD, Dolby Digital, Dolby Digital Plus, DTS-HD Master Audio, DTS, 2 CH through 8 CH L-PCM Dolby Digital and DTS support up to 48 kHz, 5.1 channels
Audio Resolution	16 bit to 24 bit
Audio Sample Rate	32 kHz, 44.1 kHz, 48 kHz, 96 kHz, 192 kHz
Local Audio Support	Yes, extraction of 2 CH L-PCM selectable by channel
Audio Switching Board & Dante Audio Switching Support	<ul style="list-style-type: none"> Supports break-away audio switching of 2 CH L-PCM for all channels Supports down-mix from one input channel of Dolby True-HD, Dolby Digital, DTS-HD, DTS, or 2 to 8 channel L-PCM Note: Down-mix supported on 4K video inputs with pixel clocks up to 297 MHz (up to 4096x2160p@30 Hz)
DDC/EDID Support	<ul style="list-style-type: none"> EDID provided by Enova DGX Digital Media Switcher to the digital (HDMI) port input and includes presets EDID is user re-programmable
HDCP Support	<ul style="list-style-type: none"> Yes, including HDCP 1.x and HDCP 2.x for full matrix HDCP support (includes any input to any or all outputs) HDCP 2.2 support required by input/output board for passage of HDCP 2.2 premium content Key Management System AMX HDCP InstaGate Pro™ Technology Key support up to 31 devices per output

DGX-I-HDMI-4K60 (FG1061-542) - Specifications (Cont.)	
HDMI w/HDCP	DESCRIPTION
CEC Support	None
HDMI Input Board Video Propagation Delay	5 us Compatible Enova DGX 100 Series Enclosures are those Enova DGX 800, 1600, 3200 or 6400 enclosures built on or after June 1, 2016.
Connectors	4 HDMI Type A Female Ports
4K HDMI Input Default Shipping EDID	Please see Input Board EDID details in the EDID Resolutions section on page 85.
<i>* Compatible Enova DGX 100 Series Enclosures are those Enova DGX 800, 1600, 3200 or 6400 enclosures built on or after June 1, 2016</i>	

Enova DGX 4K60 4:4:4 HDMI Output Board - Specifications

DGX-O-HDMI-4K60 (FG1061-552) - Specifications	
GENERAL	
Compatible AMX Products	Supported enclosures are Enova DGX 800, 1600, 3200 or 6400 Digital Media Enclosure built after June 1, 2016
Regulatory Compliance	See Enova DGX Digital Media Switcher Enclosure for regulatory compliance
HDMI w/HDCP	DESCRIPTION
Compatible Formats	HDMI 1.X, HDMI 2.0, HDCP 1.X, HDCP 2.2, DVI
Signal Type Support	HDMI, DVI-D (Single Link With HDMI Cable Adapter)
Video Data Rate (Max)	When used with compatible Enova DGX 100 series enclosures*: 18 Gbps (Max)
Video Pixel Clock (Max)	When used with compatible Enova DGX 100 series enclosures*: Up to 600 MHz
Progressive Resolution Support	When used with compatible Enova DGX 100 series enclosures* 480p up to 4096x2160 @ 60 Hz 4:4:4 including 3840x2160 @ 60 4:4:4
4K Resolution Support (Max)	When used with compatible Enova DGX 100 series enclosures*: <ul style="list-style-type: none"> • 3840x2160p @ 24/25/30/50/60 Hz, 4:4:4 • 4096x2160p @ 24/25/30/50/60 Hz, 4:4:4 • 3840x2160p @ 50/60 Hz, 4:2:0 • 4096x2160p @ 50/60 Hz, 4:2:0
HDMI Cable Requirement	Premium Certified High Speed Cable Category 2, Recommended. HDMI High Speed Cable Category 2, Required
Output Re-clocking	Yes
Output Scaling	None
Deep Color Support	24-bit, 30-bit**, 36-bit** Output signal follows input format **30-bit and 36-bit are only supported in CTA-861 formats.
HDR Support	Yes, HDR10 with ST.2084 EOTF Output signal follows input format
Color Space Support	<ul style="list-style-type: none"> • sRGB, BT.601, BT.709, BT.2020 • RGB 4:4:4; YCbCr 4:4:4 and 4:2:2 and 4:2:0 • Output signal follows input format
3D Format Support	<ul style="list-style-type: none"> • Yes (HDMI Primary Formats) • Frame Packing 1080p up to 24 Hz • Frame Packing 720p up to 50/60 Hz • Frame Packing 1080i up to 50/60 Hz • Top-Bottom 1080p up to 24 Hz • Top-Bottom 720p up to 50/60 Hz • Side-by-Side Half 1080i up to 50/60 Hz
Audio Format Support	Dolby Atmos, Dolby TrueHD, Dolby Digital, Dolby Digital Plus, DTS-HD Master Audio, DTS, 2 CH through 8 CH L-PCM
Audio Resolution	16 bit to 24 bit
Audio Sample Rate	32 kHz, 44.1 kHz, 48 kHz, 96 kHz, 192kHz
Local Audio Support	Yes, Insertion of 2 CH L-PCM selectable by channel
Audio Switching Board Support	Supports break-away audio switching of 2 CH L-PCM for all channels
DDC/EDID Support	Outputs can copy and save connected display EDID for use on Inputs as Custom EDIDs
HDCP Support	<ul style="list-style-type: none"> • Yes, including HDCP 1.x and HDCP 2.x for full matrix HDCP support (includes any input to any or all outputs) • HDCP 2.2 support required by input/output board for passage of HDCP 2.2 premium content • Key Management System • AMX HDCP InstaGate Pro™ Technology • Key support up to max 31 devices downstream on one output

DGX-0-HDMI-4K60 (FG1061-552) - Specifications	
CEC Support	None
Output +5V DDC Pin	200mA max per output port
HDMI Output Board Video Propagation Delay	5 us
Connectors	4 HDMI Type A Female Ports
HDMI Audio Synchronization (Embedded Audio Mode)	Audio lags video by 1 ms
HDMI Audio Synchronization (Switched Audio Mode)	Audio lags video by 33ms default – Adjustable down to 1 ms lag
* Compatible Enova DGX 100 Series Enclosures are those Enova DGX 800, 1600, 3200 or 6400 enclosures built on or after June 1, 2016	

4K60 HDMI Board Default EDID Resolutions Supported through Local DDC

The following tables provide the default EDID for 4K60 HDMI Boards, which is the same as the default for 4K30 boards. If 4K 50Hz or 60Hz support is desired, selection of the 4K60 EDID is required (see page 86 for details).

NOTE: In the System Configuration interface, the EDIDs contained in these tables are displayed in a single dropdown menu (General section, Preferred EDID menu), and progressive vs interface CTA VICs are differentiated by the presence of a "p" or "i" in the format.

4K HDMI DTD (Detailed Timing Descriptor)

Resolution	Refresh Rate and Aspect Ratio	Video Standard
3840x2160p*	29.97/30 Hz 16:9	CTA (VIC 95)
1920x1080p	59.94/60 Hz 16:9	CTA (VIC 16)
1920x1080p	50 Hz 16:9	CTA (VIC 31)
1920x1200	50 Hz 16:10	CVR
1920x1200	60 Hz 16:10	CVR
3840 x 2160	29.97/30 Hz 16:9	95
3840 x 2160	25 Hz 16:9	94
3840 x 2160	23.98/24 Hz 16:9	93
4096 x 2160	23.98/24 Hz 256:135	98
* This is the preferred Format identified in the EDID.		

4K HDMI CTA Video Information Code (VIC) Formats

SVD #	Resolution	Refresh Rate and Aspect Ratio	VIC #	CTA VIC	HDMI VIC
001	3840x2160p	29.97/30 Hz 16:9	VIC = 95		1
002	3840x2160p	25 Hz 16:9	VIC = 94		2
003	3840x2160p	23.98/24 Hz 16:9	VIC = 93		3
004	4096x2160p	30 Hz 256:135	VIC = 100		
005	4096x2160p	24 Hz 256:135	VIC = 98		4
006	4096x2160p	25 Hz 256:135	VIC = 99		
007	3840x2160p	30 Hz 64:27	VIC = 105		
008	3840x2160p	24 Hz 64:27	VIC = 103		
009	3840x2160p	25 Hz 64:27	VIC = 104		
010	1920x1080p	59.94/60 Hz 16:9	VIC = 16		
011	1920x1080p	23.97/24 Hz 16:9	VIC = 32		
012	1920x1080p	29.97/30 Hz 16:9	VIC = 34		
013	1920x1080p	50 Hz 16:9	VIC = 31		
014	1920x1080p	25 Hz 16:9	VIC = 33		
015	1920x1080i	59.94/60 Hz 16:9	VIC = 5		
016	1920x1080i	50 Hz 16:9	VIC = 20		
017	1280x720p	59.94/60 Hz 16:9	VIC = 4		
018	720x480p	59.94/60 Hz 16:9	VIC = 3		
019	1280x720p	50 Hz 16:9	VIC = 19		
020	720x480p	59.94/60 Hz 4:3	VIC = 2		
021	720x576p	50 Hz 4:3	VIC = 17		
022	720(1440)x480i	59.94/60 Hz 4:3	VIC = 6		
023	720(1440)x480i	59.94/60 Hz 16:9	VIC = 7		

SVD #	Resolution	Refresh Rate and Aspect Ratio	VIC #	CTA VIC	HDMI VIC
024	720x576p	50 Hz 16:9	VIC = 18		
025	720(1440)x576i	50 Hz 4:3	VIC = 21		
026	720(1440)x576i	50 Hz 16:9	VIC = 22		
027	1920x1080i	50 Hz 16:9	VIC = 39		
028	2560x1080p	60 Hz 64:27	VIC = 90		
029	2560x1080p	50 Hz 64:27	VIC = 89		
030	640x480p	59.94/60 Hz 4:3	VIC = 1		

NOTE: The Consumer Technology Association (CTA) was formerly known as the Consumer Electronics Association (CEA): the CEA 861 video standard has been renamed to CTA 861.

Audio Data Block

Channels	Sampling Frequency
Basic Audio: 2 channel L-PCM 32, 44.1, 48 kHz	Sampling frequency at 16, 20, or 24 bits per sample

NOTE: For information on troubleshooting audio, including a table on "Audio Format Support on Enova DGX Boards," see page 94.

4K60 HDMI Board EDID Resolutions - 50 Hz and 60 Hz Modes

The default EDID on the 4K60 HDMI Input board is the same as the 4K EDID on the 4K30 HDMI input boards. To enable support of 4K 50Hz or 60Hz the default EDID must be changed to select the 4K60 EDID. This can be changed either using the System Configuration Interface or the ICSP command **VIDIN_EDID-4K60** (see the *Standard Input/Output Boards: SEND_COMMANDs* section on page 213).

NOTE: In the System Configuration interface, the EDIDs contained in these tables are displayed in a single dropdown menu (General section, Preferred EDID menu), and progressive vs interface CTA VICs are differentiated by the presence of a "p" or "i" in the format.

Detailed Timings

#	Resolution	Refresh Rate and Aspect Ratio	CTA VIC
1	3840 x 2160*	59.94/60 Hz 16:9	97
2	1920 x 1080	59.94/60 Hz 16:9	16
3	1920 x 1200	50 Hz 16:10	
4	1920 x 1200	60 Hz 16:10	

* This is the preferred Format identified in the EDID.

HDMI VICs

#	Resolution	Refresh Rate and Aspect Ratio	CTA VIC	HDMI VIC
1	3840 x 2160	29.97/30 Hz 16:9	95	1
2	3840 x 2160	25 Hz 16:9	94	2
3	3840 x 2160	23.98/24 Hz 16:9	93	3
4	4096 x 2160	23.98/24 Hz 256:135	98	4

Short Video Descriptors

#	Resolution	Refresh Rate and Aspect Ratio	CTA VIC
1	3840 x 2160p	59.94/60 Hz 16:9	97
2	3840 x 2160p	50 Hz 16:9	96
3	4096 x 2160p	59.94/60 Hz 256:135	102
4	4096 x 2160p	50 Hz 256:135	101
5	3840 x 2160p	29.97/30 Hz 16:9	95
6	3840 x 2160p	25 Hz 16:9	94
7	3840 x 2160p	23.98/24 Hz 16:9	93
8	4096 x 2160p	29.97/30 Hz 256:135	100
9	4096 x 2160p	23.98/24 Hz 256:135	98
10	4096 x 2160p	25 Hz 256:135	99
11	1920 x 1080p	59.94/60 Hz 16:9	16
12	1920 x 1080p	23.98/24 Hz 16:9	32
13	1920 x 1080p	29.97/30 Hz 16:9	34
14	1920 x 1080p	50 Hz 16:9	31
15	1920 x 1080p	25 Hz 16:9	33
16	1920 x 1080i	59.94/60 Hz 16:9	5
17	1920 x 1080i	50 Hz 16:9	20
18	1280 x 720p	59.94/60 Hz 16:9	4
19	720 x 480p	59.94/60 Hz 16:9	3
20	1280 x 720	50 Hz 16:9	19
21	720 x 480i	59.94/60 Hz 16:9	7
22	720 x 576	50 Hz 16:9	18
23	720 x 576i	50 Hz 16:9	22

#	Resolution	Refresh Rate and Aspect Ratio	CTA VIC
24	1920 x 1080i	50 Hz 16:9	39
25	2560 x 1080	59.94/60 Hz 64:27	90
26	2560 x 1080	50 Hz 64:27	89
27	640 x 480	59.94/60 Hz 4:3	1

4K HDMI Standard Timings

Resolution	Refresh Rate
1920x1200	60 Hz
1680x1050	60 Hz
1600x1200	60 Hz
1440x900	60 Hz
1360x765	60 Hz
1280x1024	60 Hz
1280x800	60 Hz
1280x720	60 Hz

4K HDMI Established Timings

Resolution	Refresh Rate
1280x1024	75 Hz
1152x870	75 Hz
1024x768	60 Hz, 70 Hz, 75 Hz, 87 Hz
832x624	75 Hz
800x600	56 Hz, 60 Hz, 72 Hz, 75 Hz
720x400	70 Hz, 88 Hz
640x480	60 Hz, 67 Hz, 72 Hz, 75 Hz

Standard Timings

#	Resolution	Refresh Rate
1	1920 x 1200	60 Hz
2	1680 x 1050	60 Hz
3	1600 x 1200	60 Hz
4	1280 x 800	60 Hz
5	1280 x 720	60 Hz
6	1280 x 1024	60 Hz
7	1360 x 765	60 Hz
8	1440 x 900	60 Hz

Established Timings

#	Resolution	Refresh Rate Max
1	1280 x 1024	75 Hz
2	1152 x 864	75 Hz
3	1024 x 768	75 Hz
4	1024 x 768	70 Hz
5	1024 x 768	60 Hz
6	1024 x 384 i	87 Hz
7	832 x 624	75 Hz
8	800 x 600	75 Hz
9	800 x 600	72 Hz
10	800 x 600	60 Hz
11	800 x 600	56 Hz
12	720 x 400	88 Hz
13	720 x 400	70 Hz
14	640 x 480	75 Hz
15	640 x 480	72 Hz
16	640 x 480	67 Hz
17	640 x 480	60 Hz

Audio Data Block

Channels	Sampling Frequency
Basic Audio: 2 channel L-PCM 32, 44.1, 48 kHz	Sampling frequency at 16, 20, or 24 bits per sample

IMPORTANT: For information on troubleshooting audio, including a table on "Audio Format Support on Enova DGX Boards," see page 94.

Attaching HDMI Connectors

- The HDMI connector has a center screw for locking capability.
- Refer to the specifications tables (page 83, page 84) for detailed cable requirements.
- Use a "Premium High Speed Certified" HDMI cable for any 4K50/4K60 format.

Executing a Test Switch for an HDMI Board

We recommend becoming familiar with how HDMI switching works in an Enova DGX Switcher by reading the rest of this chapter before executing a test switch. We also recommend executing a test switch to verify the system is working correctly and then disconnecting the test switch before finishing the installation. For information on executing test switches, see page 188.

HDCP Support on Enova DGX 4K60 Switchers

The Enova DGX 4K60 HDMI Boards provide true matrix switching for complete distribution any combination of computer images and protected content. Enova DGX HDMI Boards support both HDCP 1.x encryption and HDCP 2.2 encryption and thus are able to support both previous and current generations of encrypted content seamlessly multiplexed with non-protected content. The system components work together to prevent the unauthorized transfer of protected audiovisual content to non-HDCP devices, revoked devices, as well as restrict HDCP 2.2 Premium Content to only be delivered to HDCP 2.2 authorized devices. Encrypted content is able to flow seamlessly from any input to any output as long as all devices support the minimum required capabilities for the current content.

The 4K60 system supports both HDCP 1.x and 2.2 simple receivers and/or repeaters connected to the output side as required by the HDCP 2.2 standard. Downstream Enova DGX enclosures connected (trunked) with 4K60 Boards in a Multi-stage system behave as HDCP 2.2 repeaters and can be connected in systems with up to three stages without special control code programming *so long as each stage includes at most 1 cage with 4k60 trunked connections*, i.e. the 4k60 output channel of one stage is connected to a 4k60 input channel of another stage. In this setup there is only one HDCP repeater at each stage.

A more complicated multi-stage setup might include multiple repeaters (cages with 4K60 input cards or any other repeaters). In this case, the upstream 4K60 Output Boards have to apply the HDCP 2.2 repeater topology limitations summed across *all* outputs on that stage. Any of these complicated multi-stage design will need to create control code that tracks HDCP 2.2 repeater topology limitations to prevent switching that results in switches across multiple repeaters at any given stage in a combined set that exceeds the HDCP 2.2 specification repeater topology limitations, an event that will cause the HDCP 2.2 compliant source device to block the signal at the source.

The 4K60 boards are different from previous Enova HDCP 1.x supporting boards (including DGX DVI, HDMI, DXLink Twisted Pair, and DXLink Fiber 4K30 and 2K Boards) in two areas:

1. With 4K60 HDCP 2.2 content, the revocation responsibility is retained with the source device as required by the standard so systems without 4K30 or 2K IO cards are no longer required to update the system SRM on a periodic basis.
2. Authentication failures are communicated only via the System Configuration Interface HDCP Lock symbol or asynchronous ICSP messages. The dark red "Auth Failure" screen is no longer produced. 4K60 Output Boards blank all video to black when a receiver device fails to authenticate.

Large systems should be designed to account for limitations that may exist in HDCP 2.2 devices. For example:

- Not all sources support the maximum number of standard supported downstream devices. 4K60 HDMI Boards support the HDCP 2.2 standard's maximum device list of 32. However some sources will be unable to complete authentication when presented with a full list. Avoid system routing that exceeds a source's capabilities or the source, typically, will repeatedly cycle through attempting to authenticate while dropping video on each cycle. Some legacy sources, satellite receivers for example, support only a single downstream device. To support this type of source, use an HDCP 1.x-only supporting input board to connect the source to the system. See the *Loading and Saving EDIDs* section on page 200 for details.
- Not all sources eliminate the disruption of video when a downstream device is added or removed to the current path of a source device. While the HDCP 2.2 standard recommends the non-disruption of video content when updating the active device list, it is not a requirement. 4K60 HDMI Boards implement the HDCP 2.2 recommended behavior but this does not prevent a source from disrupting video. Typical interruptions are brief, but promulgate to all routed output devices.
- Some HDCP 2.2 source devices deliver all content as HDCP 2.2 Premium Content. With these sources, content routed to all HDCP 1.x supporting boards will be blocked.
- Many HDCP 2.2 supporting sinks will also support HDCP 1.x. Connecting these devices a HDCP 1.x supporting boards will result in them never being delivered HDCP 2.2 Premium Content. HDCP 2.2 displays should always be connected to the system with 4K60 HDMI Output cards.

NOTE: *Enova DGX 4K60 Boards do not support CEC.*

NOTE: *HDCP 2.1 source devices are not supported.*

Video Troubleshooting

NOTE: Use a "Premium High Speed Certified" HDMI cable for any 4K50/4K60 format.

Video Troubleshooting	
Problem	Solution
<p>No Video: incompatible format</p> <p>If the system has determined that the full path is UNSUPPORTED for the active video format and the downstream AMX equipment, it is often reported via the sink OSD as "Incompatible Format".t</p> <p>The System Configuration Interface displays an amber bar on the channel tile (only when there is a sink plugged in.)</p> <p>In this case:</p> <ul style="list-style-type: none"> • ?VIDIN_STATUS will report UNSUPPORTED • ?VIDOUT_BLOCKED to determine if Prequal has restricted the video. Responses are NONE, SWITCHER, or LEAF. (See ICSP cmd info for details). 	<p>Either provide equipment that supports the desired format, or limit the allowed formats by loading a different EDID on the input channel</p>
<p>No Video: incompatible HDCP "Premium Content" capabilities</p> <p>The DGX system blocks Premium Content to anything except HDCP 2.2 sinks.</p> <p>The System Configuration Interface shows if Premium content is being sent under the Flags section of the Input Channel's Video Details, accessible from the channel's Video Configuration tab, e.g.</p> <p>Flags: EmbAud HDMI HDCP Premium.</p>	<p>Provide HDCP 2.2 capable sink devices for Premium Content.</p>
<p>No Video: scrambled (4K60) content</p> <p>Scrambled (4K60) content requires a handshake between upstream and downstream nodes of the system which can fail to self-recover.</p> <p>The System Configuration Interface shows if Scrambled content is being sent under the Flags section of the Input Channel's Video Details, accessible from the channel's Video Configuration tab, e.g.</p> <p>Flags: HDMI Scrambled.</p>	<p>Switch away to non scrambled source and back to the scrambled content.</p> <p>Note: Check the Video Details flags on the input channel and output channel(s) to make sure they match.</p>
<p>No Video: Capable source will not send 4K60 format</p>	<p>Load the supplied 4K60 EDID using the Switcher System Configuration Interface Configuration View or ICSP command VIDIN_EDID-4K60.</p> <p>Note: Verify video format using Switcher System Configuration Interface Configuration View or ICSP command VIDIN_RES_REF.</p>
<p>No Video: incompatible source device capabilities</p> <p>3rd Party source and sink equipment feature sets can be confusing. For example, equipment with "4K" support can mean 4K60 4:4:4 or 4K24 4:2:2 or 4K60 4:2:0 which can be incompatible</p>	<p>Either provide equipment that supports the desired format, or limit the allowed formats by loading a different EDID on the input channel.</p> <p>Note: Confirm capabilities in a simple source to sink environment, preferably with test equipment.</p>
<p>Incorrect Video: HDR capable source not providing HDR content -or- 4:2:0 capable source not providing 4:2:0 content</p>	<p>Add the support to EDID for HDR through Switcher System Configuration Interface Configuration View HDR Selection Box or via the ICSP command VIDIN_HDR-HDR10.</p> <p>Verify HDR/4:2:0 support in input EDID with the MCPU console EDID report "edid --read [i] o<num> --report".</p> <p>Look for:</p> <pre>Monitor Support ===== ... Supports HDR10: yes and/or YCbCr 4:2:0 ----- - YCbCr 4:2:0 Capability Map</pre>
<p>Black Video: stable black video displayed</p>	<p>In the following order:</p> <ol style="list-style-type: none"> 1) Disconnect output, restore switch 2) Hot plug cable (if accessible) 3) Execute a AV channel reset using the MCPU console command "reboot -u 6 BCPu:x:y" ("y" is zero indexed HW channel). <p>Note: Verify sink reports video present</p>
<p>Wrong Color Video: HDR content to non-HDR supporting sink</p> <p>Can result in "Washed out" colors on sink.</p>	<p>Verify sink EDID supports HDR with the MCPU console EDID report "edid --read [i] o<num> --report".</p> <p>Look for:</p> <pre>Monitor Support ===== ... Supports HDR10: yes ...</pre>

Video Troubleshooting (Cont.)	
Problem	Solution
<p><i>Flashing Video: persistent, identical flashing content on all "one to many" routed outputs</i></p>	<p>Execute a AV channel reset on the input using the MCPUC console command "reboot -u 6 BCPuX:y".</p> <p>if the content is HDCP and the input channel reset does not resolve, then disconnect each output allowing 5 seconds between disconnects. When the video stops flashing on all remaining outputs, you have identified the output that is repetitively failing to authenticate.</p> <p>Execute an output channel reset on that channel using the MCPUC console command "reboot -u 6 BCPuX:y".</p> <p>If this does not resolve the issue, then execute a power cycle of the sink.</p> <p>Note: Verify that the input channel is persistently cycling video - indicated in the System Configuration Interface by an input tile flashing video present, and/or input card 4 pin debug with 'S' and 'L' debug enabled.</p>
<p><i>Flashing Video: Persistent flashing content on a single output</i></p>	<p>Execute a AV channel reset on the output using the MCPUC console command "reboot -u 6 BCPuX:y".</p> <p>Note: Verify that the input channel is persistently cycling video - indicated in the System Configuration Interface by an input tile flashing video present, and/or input card 4 pin debug with 'S' and 'T' debug enabled.</p>

Audio Troubleshooting

Before troubleshooting audio, it helps to understand how the system handles EDID information: The source reads and adapts to the pre-loaded EDID on the DGX HDMI input connector. The factory default EDID is set to support 2 channel L-PCM audio. This EDID can be modified by using one of the methods described under "Possible Solutions" at the bottom of the page.

Audio Troubleshooting		
Problem	System Type	Solution
1. Audio is not present with good video...		
a. due to user error in routing the switched audio separately.	Audio Switching Boards (ASB & ASB-DAN)	Check that you are using the <i>switching mode</i> you expected when you executed the switch. If you are not using the A/V switching mode (Audio follows Video), you will need to make a separate audio switch. This is a surprisingly common error.
b. how to determine if the problem is an input side or output side issue.	All	If you are using a system with Audio Switching Boards (ASB or ASB-DAN expansion boards), see 1.a. before continuing with the rest of this solution set. 1. Regardless of the audios system type, use <i>A/V switching mode</i> (Audio follows Video) to route the audio to multiple outputs. 2. Do you get the audio anywhere? a. If the answer is no, you likely have an input side audio issue, so start with the input side issue set. b. If the answer is yes, you likely have an output side audio issue, so start with the output side issue set.
c. INPUT SIDE ISSUE - due to source's use of non-PCM source audio format with a system whose output side has a PCM 2-channel requirement (most monitors with speakers require PCM 2-channel audio on the input side as does the ASB and ASB-D audio sub-systems). <i>Note: If you have ASB boards and a mixture of output devices, some of which can handle compressed or multi-channel audio, see Configuring/ Switching the Down-mix Signal section on page 188 for information on how to set up and route your down-mix channel to those devices that only support 2-channel audio.</i>	All, excluding channels with a Solecis Transmitter	The Enova DGX default EDIDs only support Basic (2-channel) audio. If you are experiencing this problem it means 1 of 2 things: • the audio portion of your EDID is indicating support for something other than Basic, or PCM 2-Channel; or • your source device is ignoring the EDID data provide. 1. Use the System Configuration Interface to verify that the input channel's EDID Mode is set to some form of audio that your output device can handle. From the Configuration page, select the input channel and then the Audio configuration tab on the right half. Check that the EDID Mode is set to: Basic, or PCM 2-Channel. 2. If the EDID Mode is incorrect, you can fix it as follows: a. If the EDID Mode is not one of the two PCM options (Basic, or PCM 2-Channel) and is not Custom, then change the setting to one of those options. b. If the setting is Custom, follow the procedure outlined in <i>Verifying an output devices capabilities as communicated by its EDID</i> at the end of the Audio Troubleshooting table to verify the audio capabilities referenced in the custom EDID. If the audio capabilities shown in the Audio Data Block portion of the EDID include more than 2-channel LPCM, then you will need to look at your source device manual for find a way to force the audio to 2-channel audio. 3. If the EDID Mode is correct, then your source device is ignoring the EDID and you will need to look at your source device manual for find a way to force the audio to 2-channel audio.
d. INPUT SIDE ISSUE - due to source's use of non-PCM source audio format with an output side PCM 2-channel requirement (most monitors with speakers require PCM 2-channel audio on the input side as does the ASB and ASB-D audio sub-systems).	Channel with a Solecis Transmitter	See the Solecis Manual for instructions on EDID programming. <i>Note: In some instances you may need to use the DGX Configuration Software (Appendix F of the ENOVA DGX 100 SERIES DIGITAL MEDIA SWITCHERS manual to reach your final solution).</i>
e. INPUT SIDE ISSUE - due to DxLink Transmitter (DX-TX, DX-TX-WP, DX-TX-DWP) & DxLink Fiber Transmitters source audio port settings.	Any using DxLink or DxLink Fiber Transmitters	1. Verify the transmitter audio setting by using NetLink Studio to send the following commands: ?AUDIN_FORMAT_AUTO (options are ENABLED or DISABLED) ?AUDIN_FORMAT (options are HDMI, SPDIF, ANALOG) 2. Based on these settings, the audio being presented will be coming from the audio port in the table on page 94. <i>Note: If the port has no audio coming in, silent audio will be passed through the system to the output device.</i> 3. If the selected source audio port is not the port you desire, use <i>NetLink Studio</i> and the Send commands from the <i>Audio SEND_COMMANDS (Transmitters)</i> table in the <i>DxLink Transmitter Audio SEND_COMMANDS</i> section of the <i>NetLink Programming of DxLink Transmitters and Receivers</i> chapter of the Transmitter/Receiver Manual to select the port you desire. 4. If the port is the expected source audio port, then look at one of the other <i>Audio is not present with good video</i> options in this table.

Audio Troubleshooting (Cont.)		
Problem	System Type	Solution
f. INPUT SIDE ISSUE - due to Solecis Transmitter source audio port settings.	Any using Solecis 5x1 Multi-Format Transmitter (SDX-514M-DX/SDX-501M-DX)	<ol style="list-style-type: none"> 1. Verify the transmitter audio setting by using NetLinX Studio to send the following commands: <i>?AUDOUT_ASSIGN</i> 2. If the port number is not the one you expect, and: <ol style="list-style-type: none"> a. you wish to use the same audio input port as the video, then from the System Configuration Interface Configuration page, select the Input port and on the <i>SDX-514-DX 4K Digital Switcher</i> sub-section select the source you desire. b. you wish to use the analog Audio Input port with HDMI video, then use NetLinX Studio to send the audio switch command for the port you need, e.g. AI3O1 will send analog audio input port 3 to the Solecis output port. 3. If you are still no getting audio, then look at one of the other <i>Audio is not present with good video</i> options in this table.
g. INPUT SIDE ISSUE - due to the input channel's Audio Configuration settings.	All	<ol style="list-style-type: none"> 1. Select the input channel source the output channel(s) with no audio and the select the <i>Audio</i> configuration tab. 2. Verify that <i>Input Gain</i> is not set too low. Note its current setting and slide it to right to 24. If you don't get any audio, you can return it to its prior setting. If you do, then adjust it to a new desired setting.
h. INPUT SIDE ISSUE - due to carrier video signal having insufficient space for audio signal. A signal containing both video and audio must have space for both signal portions. The audio signal portion lies in the blanked portion of the video signal. High Bit Rate Audio (HBRA) requires a larger than normal space in the blanked area of the signal. Video formats with reduced blanking normally provide enough space for audio signals. In a signal that combines a video format with reduced blanking and HBRA, the HBRA signal is truncated and can present as either no audio or as problematic audio. While Enova DGX hardware supports both HBRA and reduced blanking video formats, these formats do not necessarily work with one another.	All	<p>Change either the audio format to non-HBRA or change the video format to a format that does not use reduced blanking.</p> <p>Note: <i>HBRA is only supported on CEA formats.</i></p> <p>These changes can be carried out directly on the source device (see source manual) or by manipulating the EDID in the input channel</p>
i. OUTPUT SIDE ISSUE - due to DVI output device.	All	Devices with EDIDs that report themselves as "do not support audio" and the audio is therefore blocked from being sent to the device. See <i>Verifying an output devices capabilities as communicated by its EDID</i> at end of table for more info on how identify your devices audio capabilities.
j. OUTPUT SIDE ISSUE - Audio is not present on 2-channel sink (TV/monitor) with good video while it is present on a multi-channel sink (AVR or TV/monitor that supports multi-channel audio formats). Most likely due to source's use of non-PCM source audio format with a DxLink Receiver analog output port's PCM 2-channel requirement.	Any system without Audio Switching Boards (ASB or ASB-DAN)	See 1.c. Note: <i>You will essential need to reduce audio everywhere to 2-channel for that source.</i>
k. OUTPUT SIDE ISSUE - Audio is not present on DxLink Receiver (DX-RX, DX-RX-4k) analog output port with good video due to source's use of non-PCM source audio format with a DxLink Receiver analog output port's PCM 2-channel requirement.	Any using a DxLink Receiver's analog output port	See 1.c. if you do not have Audio Switching Boards (ASB or ASB-DAN). See 1.m. if you do have Audio Switching Boards (ASB or ASB-DAN), you can use the audio Downmix channel to deliver audio to your 2-channel only output devices. See <i>Configuring/Switching the Down-mix Signal</i> section on page 188 for information on how to set up and route your downmix channel.
l. OUTPUT SIDE ISSUE - Audio is not present on ASB analog output channel or ASB-D Dante channel with good video due to source's use of non-PCM source audio format with an switched audio sub-system PCM 2-channel requirement.	Audio Switching Boards (ASB or ASB-DAN)	If you have a system design that only supports 2-channel audio on all of the system outputs, then see 1.c. If you have ASB boards and a mixture of output devices, some of which can handle compressed or multi-channel audio, see <i>Configuring/Switching the Down-mix Signal</i> section on page 188for information on how to set up and route your down-mix channel to those devices that only support 2-channel audio.

Audio Troubleshooting (Cont.)		
Problem	System Type	Solution
m. OUTPUT SIDE ISSUE - Audio is not present on 2-channel sink (TV/monitor) with good video while it is present on a multi-channel sink (AVR or TV/monitor that supports multi-channel audio formats). Most likely due to source's use of non-PCM source audio format with a DxLink Receiver analog output port's PCM 2-channel requirement.	Audio Switching Boards (ASB or ASB-DAN)	<ol style="list-style-type: none"> 1. It is recommended that you set up all 2-channel-PCM-only sinks to use switched audio. 2. Use the audio Downmix channel to deliver audio to your 2-channel only output devices. See <i>Configuring/Switching the Down-mix Signal</i> section on page 188 for information on how to set up and route your downmix channel.
n. OUTPUT SIDE ISSUE - Audio is not present with good video due to the output channel's Audio Configuration settings.	Audio Switching Boards (ASB or ASB-DAN)	<ol style="list-style-type: none"> 1. Select the output channel with no audio and then select the <i>Audio</i> configuration tab. 2. Verify that <i>Mute</i> is not checked. If it is checked, uncheck it. 3. Verify that the <i>Output Volume</i> is set to 100%. If it is not set to 100%, note its current setting and slide it to 100% to see if you get any audio. If you don't get any audio, you can return it to its prior setting. If you do, then adjust it to a new desired setting.
2. Audio sounds like a rattlesnake or all hiss.		
a. Occurs when you have a mismatch between the audio source and the audio output devices capabilities, such that the source is sending Dolby Digital or DTS compressed audio to a device that can't uncompress it, e.g. a 2-ch PCM device. AIE You can get this sound if you are attempting to extract compressed audio, which is not a supported operation.	No Audio Boards or AIE Board(s)	See 1.c. above.
b. Occurs when you have a mismatch between the audio source and the audio output devices capabilities, such that the source is sending Dolby Digital or DTS compressed audio to a device that can't uncompress it, e.g. a 2-ch PCM device.	Audio Switching Boards (ASB or ASB-DAN) <i>Switched Only</i>	The Audio Switching Board sub-system suppresses any non-2-channel audio for the audio switching sub-system, so that you should rarely hear this and if you do, it will be extremely brief. See the <i>Configuring/Switching the Down-mix Signal</i> section on page 188 for information on how to set up and route your downmix channel to get good audio to this channel. If you want to force your source to only put out 2-channel PCM audio, see 1.c. above.
c. Occurs when you have a mismatch between the audio source and the audio output devices capabilities, such that the source is sending Dolby Digital or DTS compressed audio to a device that can't uncompress it, e.g. a 2-ch PCM device.	Audio Switching Boards (ASB or ASB-DAN) <i>Embedded Only</i>	Use the System Configuration Interface's Configuration page for the output channel to use switched audio by: <ol style="list-style-type: none"> 1. Selecting the output channel and then the <i>Audio</i> tab on configuration side of the page. 2. In the <i>General</i> sub-section, click on the <i>Switched</i> button below <i>Audio Routing</i>. This will eliminate the hiss. 3. See the <i>Configuring/Switching the Down-mix Signal</i> section on page 188 for information on how to set up and route your downmix channel.
Other Audio issues		
INPUT SIDE ISSUE - Downmix audio is not present with good video. Assuming you have gone through problem determination steps 1 a & b above, and you have determined that problem with the down mix input.	ASB Switched Downmix Audio ASB-D Switched Downmix Audio	Reboot audio output board from the System Configuration Interface's Status page. Note: <i>this will kill all switched audio on the entire system for a few seconds.</i>
Verifying an output devices capabilities as communicated by its EDID		
<p>An output device communicate its audio and video format capabilities to the source device via its EDID.</p> <p>To check if a destination supports a particular type of audio format, capture the EDID using the System Configuration Interface's <i>Save EDID</i> function and then paste the data from the .edid file into an EDID reader program (e.g., www.edidreader.com).</p> <p>The audio capabilities data is in Block 1 under the Audio Data Block and the Speaker Allocation Data sections.</p> <p>If the device only supports 2-channel LPCM, this will be the only audio referenced in this Audio Data Block.</p>		

NOTE: *Other audio troubleshooting problems and solution can be found in the audio boards chapters specific to: Enova DGX Dante™ Audio Switching Boards (page 150), Enova DGX Audio Switching Boards (page 164), and Enova DGX Audio Insert/Extract Boards (page 175).*

Determining the DxLink Transmitter Source Audio Port

Active Video	?AUDIN_FORMAT_AUTO	Source Audio Port
HDMI	ENABLED	HDMI
VGA/Analog	ENABLED	Whichever port is set in ?AUDIN_FORMAT
HDMI	DISABLED	Whichever port is set in ?AUDIN_FORMAT
VGA/Analog	DISABLED	Whichever port is set in ?AUDIN_FORMAT

Audio Format Support on Enova DGX Boards

The following table indicates which audio formats are supported by specific Enova DGX boards.

Audio Format Support on Enova DGX Boards											
Audio Format	Board Types	4K60 HDMI Input and Output boards	HDMI / 4K HDMI Input Boards	HDMI Output Boards	DVI Input Boards	DVI Output Boards	DXLink Twisted Pair Input and Output Boards	DXLink Fiber Input and Output Boards	Dante Audio Switching Boards	Audio Switching Boards (ASB and ASB-DAN)	Audio Insert/Extract Expansion Boards (input and output)
2 Channel L-PCM		•	•	•	•	•	•	•	•	•	•
6 Channel L-PCM		•	•	•	•	•	•	•			
8 Channel L-PCM		•	•	•	•	•	•	•			
Dolby Digital		•	•	•	•	•	•*	•*			
DTS		•	•	•	•	•	•*	•*			
Dolby TrueHD		•	•		•		•	•			
DTS-HD Master		•	•		•		•	•			
Dolby Atmos		•									
* Dolby Digital and DTS support up to 48 kHz, 5.1 channels.											

NOTE: In order to pass audio over the DVI Input boards their EDID need to be changed to an HDMI EDID which allow Audio formats to be seen as supported by the source.

IMPORTANT: Signals routed through HDMI, 4K HDMI, 4K60 HDMI, DVI, DXLink Twisted Pair, and DXLink Fiber Boards normally produce a quality image. If the installation has special scaling, EDID, or HDCP requirements, see page 199.

HDMI Input & Output Boards

Overview

This chapter pertains to Enova DGX HDMI Input Boards and HDMI Output Boards:

- FG1058-540 Input board
- FG1061-540 4K HDMI Input Board
- FG1058-550 Output board

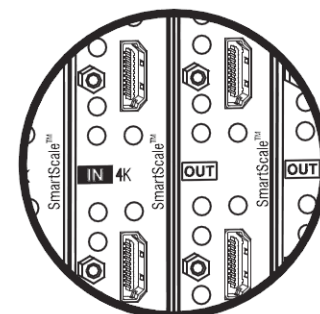
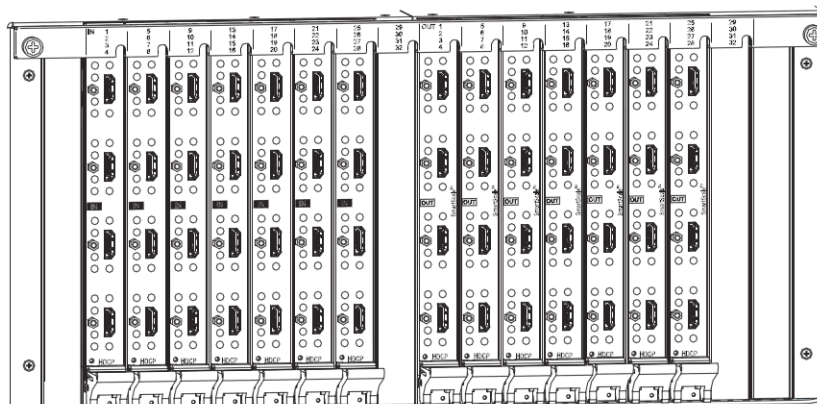

Enova DGX 4K HDMI Boards indicate "4K" beside the IN or OUT label.

FIG. 39 Enova DGX HDMI Input and Output Boards

Enova DGX Enclosure Support for HDMI Input & Output Boards	
DGX 800	Enova DGX 800 enclosures can hold up to four DGX HDMI Boards with four inputs or outputs per board. Each enclosure holds a maximum of two input and two output boards, accommodating connector configurations up to a maximum of 8x8, as well as three subsets (i.e., 4x4, 4x8, or 8x4).
DGX 1600	Enova DGX 1600 enclosures can hold up to eight DGX HDMI Boards with four inputs or outputs per board. Each enclosure holds a maximum of four input and four output boards, accommodating connector configurations up to a maximum of 16x16, as well as subsets (e.g., 16x8 or 4x12).
DGX 3200	Enova DGX 3200 enclosures can hold up to sixteen DGX HDMI Boards with four inputs or outputs per board. Each enclosure holds a maximum of eight input and eight output boards, accommodating connector configurations up to a maximum of 32x32, as well as subsets in increments of four (e.g., 12x20 or 24x8).
DGX 6400	Enova DGX 6400 enclosures can hold up to thirty-two DGX HDMI Boards with four inputs or outputs per board. Each enclosure holds a maximum of sixteen input and sixteen output boards, accommodating connector configurations up to a maximum of 64x64, as well as subsets in increments of four (e.g., 12x48 or 52x8).

Signal Routing

DGX HDMI Input Boards route signals to DGX HDMI Output Boards or to any other type of Enova DGX Output Boards. HDMI Output Boards can also accept signals from all of the other types of Enova DGX Boards. When routing signals between different board types, the Enova DGX Switcher automatically converts the signal format to match the output board.

The HDMI connectors are designed to route high-resolution HDMI or DVI signals with or without HDCP (High-bandwidth Digital Content Protection). DVI signals must be single link DVI-D and require the use of a cable adapter. Destinations with DVI-I or single-link DVI-D connectors are supported.

NOTE: HDMI Boards can also work in conjunction with Audio Switching Boards (see page 164) or AIE Boards (see page 175).

IMPORTANT: Signals through HDMI Boards in the Enova DGX Switcher normally produce a quality image and provide support for the most flexible audio settings because the connectors are pre-loaded with the most common EDID settings to ensure they will work with the source devices. In addition to common EDIDs on the inputs, SmartScale on every output also greatly helps ensure that all signals are satisfactory. Therefore, adjustments are not necessary unless the installation has special scaling, EDID, or HDCP requirements. If changes to EDID settings or scaling settings are needed, use the System Configuration interface (see page 127)

4K Signal Routing

By default, 4K HDMI Input Boards route 4K video from an attached source device through the Enova DGX to an output board (or via a DXLink Output Board to a DXLink Receiver). In order to receive 4K video at the destination device, the entire signal path (e.g., source device, input board, output board, receiver module, and destination device) must support 4K video formats.

4K signals passed to output boards or Receiver Modules that are not 4K capable result in no signals being shown on the destination device. To resolve compatibility issues, change the format from the source device or route the 4K formatted signal to a 4K capable output board/Receiver. 4K HDMI Boards require Category 2 high-speed cable for use with 4K content.

InstaGate Pro and SmartScale

- HDMI Boards are HDCP 1.4 compatible and feature InstaGate Pro Technology for low-latency switching of HDCP protected content and support computer video up to 1920x1200 and HDTV up to 1080p. The HDMI Boards also support embedded audio, both linear PCM (stereo audio) and non-linear PCM (Dolby Digital, DTS, Dolby TrueHD, etc.).

NOTE: *InstaGate Pro Technology eliminates HDCP latency and interruptions on all displays in a system. (These conditions are typically experienced when HDCP authenticates HDMI source and destination devices.) With InstaGate Pro Technology, when a source requires HDCP encrypted content, the inputs and compliant downstream devices are automatically authenticated ? it just works.*

- 4K HDMI Boards are HDCP 1.4 compatible and feature InstaGate Pro Technology* for low-latency switching of HDCP protected content and support progressive resolutions from 480p up to 4096x2160p@60Hz (Y/Cb/Cr 4:2:0). 4K HDMI Boards also support embedded audio, both linear PCM (stereo audio) and non-linear PCM (Dolby Digital, DTS, Dolby TrueHD, etc.).
- HDMI Boards meet HDCP Standards. For information on HDCP functionality for HDMI Boards, see "HDCP Support on Enova DGX Switchers" on page 103.
- HDMI Boards provide EDID emulation support with plug-and-play information provided by the Enova DGX Switcher.
- HDMI Output Boards feature SmartScale Technology which automatically responds to the preferred EDID information and scales the video to the best resolution and video settings for that display without manual setup.

Enova DGX HDMI Input Board - Specifications

DGX HDMI Input Board - Specifications	
GENERAL	
Compatible AMX Products	Supported enclosures are Enova DGX 800, 1600, 3200 or 6400 Digital Media Enclosure built after June 1, 2016
Regulatory Compliance	See Enova DGX Digital Media Switcher Enclosure for regulatory compliance
HDMI w/HDCP	DESCRIPTION
Compatible Formats	HDMI 1.X, HDMI 2.0, HDCP 1.X, HDCP 2.2, DVI
Signal Type Support	HDMI, DisplayPort++ (Input Only) DVI-D (Single Link With HDMI Cable Adapter)
Video Data Rate (Max)	When used with compatible Enova DGX 100 series enclosures*: 18 Gbps (Max)
Video Pixel Clock (Max)	When used with compatible Enova DGX 100 series enclosures*: Up to 600 MHz
Progressive Resolution Support	When used with compatible Enova DGX 100 series enclosures*: 480p up to 4096x2160 @ 60Hz, 4:4:4
Interlaced Resolution Support	480i, 576i, 1080i NOTE: If input is interlaced, all scaled outputs will de-interlace video to a progressive resolution format. If non-scaled output board or if scaler is in Bypass mode, interlaced input will pass through unaltered.
4K Resolution Support (Max)	When used with compatible Enova DGX 100 series enclosures*: <ul style="list-style-type: none"> 3840x2160p @ 24/25/30/50/60 Hz, 4:4:4 4096x2160p @ 24/25/30/50/60 Hz, 4:4:4 3840x2160p @ 50/60 Hz, 4:2:0** 4096x2160p @ 50/60 Hz, 4:2:0** ** Supported by DX-RX-4K when in Bypass Scaling mode.
HDMI Cable Requirement	Premium Certified High Speed Cable Category 2, Recommended. HDMI High Speed Cable Category 2, Required
Input Equalization	Adaptive up to 21ft (7m). Cable distance support dependent on cable quality and signal format
Input Re-clocking (CDR)	Yes
Deep Color Support	24-bit, 30-bit***, 36-bit*** ***30-bit and 36 bit are only supported in CTA-861 formats. When switched to an output board or RX with Scaling support the Scaler must be in Bypass mode.
HDR Support	Yes HDR10 Output signal follows input format Note: Requires the use of HDR compatible output board such as 4K60 HDMI Output Board
Color Space Support	sRGB, BT.601, BT.709, BT.2020 RGB 4:4:4, YCbCr 4:4:4, 4:2:2, and 4:2:0 <ul style="list-style-type: none"> Input signal support for YCbCr 4:4:4 and 4:2:2, output color-space is converted to RGB 4:4:4 on scaled output Output signal follows input format on non-scaled output boards If 4:2:0 is switched to a 4K RX the RX scaler must be set to bypass

DGX HDMI Input Board- Specifications (Cont.)	
HDMI w/HDCP	DESCRIPTION
3D Format Support	<ul style="list-style-type: none"> • Frame Packing 1080p up to 24 Hz • Frame Packing 720P up to 50/60 Hz • Frame Packing 1080i up to 50/60 Hz • Top-Bottom 1080p up to 24 Hz • Top-Bottom 720p up to 50/60 Hz • Side-by-Side Half 1080i up to 50/60 Hz <p>Note: If scale is present on corresponding output board or the RX it must be set to Bypass mode</p>
Audio Format Support	<ul style="list-style-type: none"> • Dolby Atmos, Dolby TrueHD, Dolby Digital, Dolby Digital Plus, DTS-HD Master Audio, DTS, 2 CH through 8 CH L-PCM • Dolby Digital and DTS support up to 48 kHz, 5.1 channels
Audio Resolution	16 bit to 24 bit
Audio Sample Rate	32 kHz, 44.1 kHz, 48 kHz, 96 kHz, 192 kHz
Local Audio Support	Yes, extraction of 2 CH L-PCM selectable by channel
Audio Switching Board Support	<ul style="list-style-type: none"> • Supports break-away audio switching of 2 CH L-PCM for all channels • Supports down-mix from one input channel of Dolby True-HD, Dolby Digital, DTS-HD, DTS, or 2 to 8 channel L-PCM <p>Note: Down-mix supported on 4K video inputs with pixel clocks up to 297 MHz (up to 4096x2160p@30 Hz)</p>
DDC/EDID Support	<ul style="list-style-type: none"> • EDID provided by Enova DGX Digital Media Switcher to the digital (HDMI) port input and includes presets • EDID is user re-programmable
HDCP Support	<ul style="list-style-type: none"> • Yes, including HDCP 1.x and HDCP 2.x for full matrix HDCP support (includes any input to any or all outputs) • HDCP 2.2 support required by input/output board for passage of HDCP 2.2 premium content • Key Management System • AMX HDCP InstaGate Pro™ Technology • Key support up to 31 devices per output
CEC Support	None
Input Propagation Delay	5 us
Connectors	4 HDMI Type A Female Ports
4K HDMI INPUT DEFAULT SHIPPING EDID¹	
Detailed Timing Descriptors (DTD)	<ul style="list-style-type: none"> • 3840x2160p¹@ 30 Hz CTA (VIC 95) • 1920x1080p @ 60 Hz CTA (VIC 16) • 1920x1080p @ 50 Hz CTA (VIC 31) • 1920x1200 @ 50 Hz CVR • 1920x1200 @ 60 Hz CVR <p>¹This is the preferred format DTD identified in the EDID. Note: The default EDID can be configured to include support for 4K 60 4:4:4, HDMI mode or audio capabilities or overwritten with custom EDID capture from output devices</p>
Standard Timing Identification	<ul style="list-style-type: none"> • 1920x1200 @ 60 Hz • 1680x1050 @ 60 Hz • 1600x1200 @ 60 Hz • 1440x900 @ 60 Hz • 1360x765 @ 60 Hz • 1280x1024 @ 60 Hz • 1280x800 @ 60 Hz • 1280x720 @ 60 Hz
Established Timing	<ul style="list-style-type: none"> • 1280x1024 @ 75 Hz • 1152x870 @ 75 Hz • 1024x768 @ 60 Hz, 70 Hz, 75 Hz, 87 Hz • 832x624 @ 75 Hz • 800x600 @ 56 Hz, 60 Hz, 72 Hz, 75 Hz • 720x400 @ 70 Hz, 88 Hz • 640x480 @ 60 Hz, 67 Hz, 72 Hz, 75 Hz

DGX HDMI Input Board- Specifications (Cont.)	
4K HDMI INPUT DEFAULT SHIPPING EDID¹ (Cont.)	
CTA Video Information Code (VIC) Formats	<ul style="list-style-type: none"> • SVD 001 VIC = 95 3840x2160p 29.97/30 Hz 16:9 • SVD 002 VIC = 94 3840x2160p 25 Hz 16:9 • SVD 003 VIC = 93 3840x2160p 23.98/24 Hz 16:9 • SVD 004 VIC = 100 4096x2160p 30 Hz 256:135 • SVD 005 VIC = 98 4096x2160p 24 Hz 256:135 • SVD 006 VIC = 99 4096x2160p 25 Hz 256:135 • SVD 007 VIC = 105 3840x2160p 30 Hz 64:27 • SVD 008 VIC = 103 3840x2160p 24 Hz 64:27 • SVD 009 VIC = 104 3840x2160p 25 Hz 64:27 • SVD 010 VIC = 16 1920x1080p 59.94/60 Hz 16:9 • SVD 011 VIC = 32 1920x1080p 23.97/24 Hz 16:9 • SVD 012 VIC = 34 1920x1080p 29.97/30 Hz 16:9 • SVD 013 VIC = 31 1920x1080p 50 Hz 16:9 • SVD 014 VIC = 33 1920x1080p 25 Hz 16:9 • SVD 015 VIC = 5 1920x1080i 59.94/60 Hz 16:9 • SVD 016 VIC = 20 1920x1080i 50 Hz 16:9 • SVD 017 VIC = 4 1280x720p 59.94/60 Hz 16:9 • SVD 018 VIC = 3 720x480p 59.94/60 Hz 16:9 • SVD 019 VIC = 19 1280x720p 50 Hz 16:9 • SVD 020 VIC = 2 720x480p 59.94/60 Hz 4:3 • SVD 021 VIC = 17 720x576p 50 Hz 4:3 • SVD 022 VIC = 6 720(1440)x480i 59.94/60 Hz 4:3 • SVD 023 VIC = 7 720(1440)x480i 59.94/60 Hz 16:9 • SVD 024 VIC = 18 720x576p 50 Hz 16:9 • SVD 025 VIC = 21 720(1440)x576i 50 Hz 4:3 • SVD 026 VIC = 22 720(1440)x576i 50 Hz 16:9 • SVD 027 VIC = 39 1920x1080i 50 Hz 16:9 • SVD 028 VIC = 90 2560x1080p 60 Hz 64:27 • SVD 029 VIC = 89 2560x1080p 50 Hz 64:27 • SVD 030 VIC = 1 640x480p 59.94/60 Hz 4:3
Audio Data Block	Basic Audio: 2 Channel L-PCM 32, 44.1, 48 kHz Sampling Frequency at 16, 20 or 24 bits per sample.
<i>*Compatible Enova DGX 100 Series Enclosures are those Enova DGX 800, 1600, 3200 or 6400 enclosures built on or after June 1, 2016.</i>	

Enova DGX HDMI Output Board - Specifications

DGX HDMI Output Board - Specifications	
GENERAL	
Compatible AMX Products	Supported enclosures are Enova DGX 800, 1600, 3200 or 6400 Digital Media Enclosure built after June 1, 2016
Regulatory Compliance	See Enova DGX Digital Media Switcher Enclosure for regulatory compliance
HDMI w/HDCP	DESCRIPTION
Compatible Formats	HDMI 1.X, HDMI 2.0, HDCP 1.X, HDCP 2.2, DVI
Signal Type Support	HDMI, DisplayPort++ DVI-D (Single Link With HDMI Cable Adapter)
Video Data Rate (Max)	When used with compatible Enova DGX 100 series enclosures*: 18 Gbps (Max)
Video Pixel Clock (Max)	When used with compatible Enova DGX 100 series enclosures*: Up to 600 MHz
Progressive Resolution Support	When used with compatible Enova DGX 100 series enclosures* 480p up to 4096x2160@ 60 Hz 4:4:4 including 3840x2160 @ 60 4:4:4
4K Resolution Support (Max)	When used with compatible Enova DGX 100 series enclosures*: <ul style="list-style-type: none"> • 3840x2160p @ 24/25/30/50/60 Hz, 4:4:4 • 4096x2160p @ 24/25/30/50/60 Hz, 4:4:4 • 3840x2160p @ 50/60 Hz, 4:2:0 • 4096x2160p @ 50/60 Hz, 4:2:0
HDMI Cable Requirement	Premium Certified High Speed Cable Category 2, Recommended. HDMI High Speed Cable Category 2, Required
Output Re-clocking	Yes
Output Scaling	None
Deep Color Support	24-bit, 30-bit**, 36-bit** Output signal follows input format **30-bit and 36-bit are only supported in CTA-861 formats.
HDR Support	Yes HDR10 Output signal follows input format
Color Space Support	<ul style="list-style-type: none"> • sRGB, BT601, BT.709, BT.2020 • RGB 4:4:4; YCbCr 4:4:4 and 4:2:2 and 4:2:0 • Output signal follows input format
3D Format Support	<ul style="list-style-type: none"> • Yes (HDMI Primary Formats) • Frame Packing 1080p up to 24 Hz • Frame Packing 720p up to 50/60 Hz • Frame Packing 1080i up to 50/60 Hz • Top-Bottom 1080p up to 24 Hz • Top-Bottom 720p up to 50/60 Hz • Side-by-Side Half 1080i up to 50/60 Hz
Audio Format Support	Dolby Atmos, Dolby TrueHD, Dolby Digital, Dolby Digital, Plus, DTS-HD Master Audio, DTS, 2 CH through 8 CH L-PCM
Audio Resolution	16 bit to 24 bit
Audio Sample Rate	32 kHz, 44.1 kHz, 48 kHz, 96 kHz, 192kHz
Local Audio Support	Yes, Insertion of 2 CH L-PCM selectable by channel
DDC/EDID Support	Outputs can copy and save connected display EDID for use on Inputs as Custom EDIDs
HDCP Support	<ul style="list-style-type: none"> • Yes, including HDCP 1.x and HDCP 2.x for full matrix HDCP support (includes any input to any or all outputs) • HDCP 2.2 support required by input/output board for passage of HDCP 2.2 premium content • Key Management System • AMX HDCP InstaGate Pro™ Technology • Key support up to max 31 devices downstream on one output
CEC Support	None
Output +5V DDC Pin	200mA max per output port
Connectors	4 HDMI Type A Female Ports
HDMI Output Board Propagation Delay	5 us
HDMI Audio Synchronization (Embedded Audio Mode)	Audio lags video by 1 ms
HDMI Audio Synchronization (Switched Audio Mode)	Audio lags video by 33ms default – Adjustable down to 1 ms lag
Audio Switching Board Support	Supports break-away audio switching of 2 CH L-PCM for all channels
* Compatible Enova DGX 100 Series Enclosures are those Enova DGX 800, 1600, 3200 or 6400 enclosures built on or after June 1, 2016	

HDMI Board EDID Resolutions Supported via Local DDC

Standard and established timings are given in the tables following along with detailed timing blocks.

NOTE: This section covers all of the default EDIDs for HDMI Input and Output Boards (not 4K HDMI Boards). In the System Configuration interface, the EDIDs contained in this section's tables are displayed in a single dropdown menu (General section, Preferred EDID menu) and VICs are differentiated by the presence of a "p" or "l" in the format. EDID information for 4K HDMI Boards is located on the following page.

IMPORTANT: The EDID can be re-programmed to support additional resolutions through the local DDC using the EDID programming functionality in the System Configuration interface (see page 140).

Standard Timings (Default Shipping EDID)

NOTE: The default EDID can be overwritten to include a broad range of features, including HDMI mode, based on installation requirements.

Resolution	Refresh Rate Max.
1920x1080	60 Hz (Preferred timing identified in the EDID.)
1920x1200	60 Hz
1680x1050	60 Hz
1600x1200	60 Hz
1600x900	60 Hz
1400x1050	60 Hz
1440x900	60 Hz
1360x765	60 Hz
1280x1024	60 Hz
1280x960	60 Hz
1280x800	60 Hz
1280x720	60 Hz

Established Timings

Resolution	Refresh Rate Max.
1280x1024	75 Hz
1152x870	75 Hz
1024x768	60 Hz, 70 Hz, 75 Hz, 87 Hz
832x624	75 Hz
800x600	56 Hz, 60 Hz, 72 Hz, 75 Hz
720x400	70 Hz, 88 Hz
640x480	60 Hz, 67 Hz, 72 Hz, 75 Hz

NOTE: Audio problems may result from passing Dolby or DTS or high PCM frequency rates to a destination device that does not support them. Video problems may result from passing a video format that the destination device does not support. In either of these cases, re-programming the EDID may help resolve the problem.

HDMI CTA Video Information Code (VIC) Formats

NOTE: CTA VIC formats for 4K HDMI Boards are on page 102.

VIC #	Resolution	Refresh Rate and Aspect Ratio
VIC = 1	640x480p	59.94/60 Hz 4:3
VIC = 2	720x480p	59.94/60 Hz 4:3
VIC = 3	720x480p	59.94/60 Hz 16:9
VIC = 4	1280x720p	59.94/60 Hz 16:9
VIC = 5	1920x1080i	59.94/60 Hz 16:9
VIC = 6	720(1440)x480i	59.94/60 Hz 4:3
VIC = 7	720(1440)x480i	59.94/60 Hz 16:9
VIC = 14	1440x480p	59.94/60 Hz 4:3
VIC = 15	1440x480p	59.94/60 Hz 16:9
VIC = 16	Native 1920x1080p	59.94/60 Hz 16:9
VIC = 17	720x576p	50 Hz 4:3
VIC = 18	720x576p	50 Hz 16:9
VIC = 19	1280x720p	50 Hz 16:9
VIC = 20	1920x1080i	50 Hz 16:9
VIC = 21	720(1440)x576i	50 Hz 4:3
VIC = 22	720(1440)x576i	50 Hz 16:9
VIC = 29	1440x576p	50 Hz 4:3
VIC = 30	1440x576p	50 Hz 16:9
VIC = 31	1920x1080p	50 Hz 16:9
VIC = 32	1920x1080p	23.97/24 Hz 16:9
VIC = 33	1920x1080p	25 Hz 16:9
VIC = 34	1920x1080p	29.97/30 Hz 16:9
VIC = 39	1920x1080i	50 Hz 16:9
VIC = 41	1280x720p	100 Hz 16:9
VIC = 42	720x576p	100 Hz 4:3
VIC = 43	720x576p	100 Hz 16:9
VIC = 44	720(1440)x576i	100 Hz 4:3
VIC = 45	720(1440)x576i	100 Hz 16:9
VIC = 47	1280x720p	119.88/120 Hz 16:9
VIC = 48	720x480p	119.88/120 Hz 4:3
VIC = 49	720x480p	119.88/120 Hz 16:9

NOTE: The Consumer Technology Association (CTA) was formerly known as the Consumer Electronics Association (CEA); the CEA 861 video standard has been renamed to CTA 861.

Audio Data Block

Channels	Sampling Frequency
Basic Audio: 2 channel L-PCM 32, 44.1, 48 kHz	Sampling frequency at 16, 20, or 24 bits per sample

IMPORTANT: For information on troubleshooting audio, including "Audio Format Support on Enova DGX Boards," see page 105.

4K HDMI Board EDID Resolutions Supported through Local DDC

This section covers all of the default EDIDs for 4K HDMI Boards. In the System Configuration interface, the EDIDs contained in this section's tables are displayed in a single dropdown menu (General section, Preferred EDID menu) and VICs are differentiated by the presence of a "p" or "i" in the format.

EDID information for HDMI Input and Output Boards is located on the previous page.

4K HDMI DTD (Detailed Timing Descriptor)

Resolution	Refresh Rate Max.	Video Standard
3840x2160p (Preferred DTD identified in the EDID)	30 Hz	CTA (VIC 95)
1920x1080p	60 Hz	CTA (VIC 16)
1920x1080p	50 Hz	CTA (VIC 31)
1920x1200	50 Hz	CVR
1920x1200	60 Hz	CVR

4K HDMI Standard Timings

Resolution	Refresh Rate Max.
1920x1200	60 Hz
1680x1050	60 Hz
1600x1200	60 Hz
1440x900	60 Hz
1360x765	60 Hz
1280x1024	60 Hz
1280x800	60 Hz
1280x720	60 Hz

4K HDMI Established Timings

Resolution	Refresh Rate Max.
1280x1024	75 Hz
1152x870	75 Hz
1024x768	60 Hz, 70 Hz, 75 Hz, 87 Hz
832x624	75 Hz
800x600	56 Hz, 60 Hz, 72 Hz, 75 Hz
720x400	70 Hz, 88 Hz
640x480	60 Hz, 67 Hz, 72 Hz, 75 Hz

4K HDMI CTA Video Information Code (VIC) Formats

- CTA VIC formats for HDMI Boards are located on page 101.
- The Short Video Descriptor (SVD) column describes the order of video preference.

SVD #	VIC #	Resolution	Refresh Rate and Aspect Ratio	Notes
001	VIC = 95	3840x2160p	29.97/30 Hz 16:9	HDMI VIC = 1
002	VIC = 94	3840x2160p	25 Hz 16:9	HDMI VIC = 2
003	VIC = 93	3840x2160p	23.98/24 Hz 16:9	HDMI VIC = 3
004	VIC = 100	4096x2160p	30 Hz 256:135	
005	VIC = 98	4096x2160p	24 Hz 256:135	HDMI VIC = 4
006	VIC = 99	4096x2160p	25 Hz 256:135	
007	VIC = 105	3840x2160p	30 Hz 64:27	
008	VIC = 103	3840x2160p	24 Hz 64:27	
009	VIC = 104	3840x2160p	25 Hz 64:27	
010	VIC = 16	1920x1080p	59.94/60 Hz 16:9	
011	VIC = 32	1920x1080p	23.97/24 Hz 16:9	
012	VIC = 34	1920x1080p	29.97/30 Hz 16:9	
013	VIC = 31	1920x1080p	50 Hz 16:9	
014	VIC = 33	1920x1080p	25 Hz 16:9	
015	VIC = 5	1920x1080i	59.94/60 Hz 16:9	
016	VIC = 20	1920x1080i	50 Hz 16:9	
017	VIC = 4	1280x720p	59.94/60 Hz 16:9	
018	VIC = 3	720x480p	59.94/60 Hz 16:9	
019	VIC = 19	1280x720p	50 Hz 16:9	
020	VIC = 2	720x480p	59.94/60 Hz 4:3	
021	VIC = 17	720x576p	50 Hz 4:3	
022	VIC = 6	720(1440)x480i	59.94/60 Hz 4:3	
023	VIC = 7	720(1440)x480i	59.94/60 Hz 16:9	
024	VIC = 18	720x576p	50 Hz 16:9	
025	VIC = 21	720(1440)x576i	50 Hz 4:3	
026	VIC = 22	720(1440)x576i	50 Hz 16:9	
027	VIC = 39	1920x1080i	50 Hz 16:9	
028	VIC = 90	2560x1080p	60 Hz 64:27	
029	VIC = 89	2560x1080p	50 Hz 64:27	
030	VIC = 1	640x480p	59.94/60 Hz 4:3	

Audio Data Block

Channels	Sampling Frequency
Basic Audio: 2 channel L-PCM 32, 44.1, 48 kHz	Sampling frequency at 16, 20, or 24 bits per sample

NOTE: For information on troubleshooting audio, including a table on "Audio Format Support on Enova DGX Boards," see page 105.

Attaching HDMI Connectors

4K HDMI Boards require Category 2 high-speed cable for use with 4K content.

NOTE: *If a device with an EDID (e.g., a video processor) is installed between the output and destination monitor, the scaler override function will read the EDID for that device. If this happens, we suggest a procedure where you first connect the output to the monitor and Save the EDID (see page 141) then connect the output to the device and the device to the destination monitor. When all connections are made, Load the previously saved EDID (see page 141).*

- The HDMI connector has a center screw for locking capability.
- Refer to the specifications table (page 96) for detailed cable requirements.

Executing a Test Switch for an HDMI Board

Execute a test switch to verify the system is working correctly, then disconnecting the test switch before finishing the installation. See the *Executing a Test Switch* section on page 70 for details.

HDCP Support on Enova DGX Switchers

The Enova DGX HDMI Boards provide true matrix switching for complete distribution of high resolution digital video and embedded audio from the sources to the destinations (audio can also be inserted or extracted with the use of Audio Insert/Extract Boards; see page 183).

NOTE: *This section also applies to DGX DVI, DXLink Twisted Pair, and DXLink Fiber Boards.*

Full-matrix HDMI support allows protected entertainment content to be switched freely, while its high resolution capabilities provide the advantage of being able to use this solution to switch high resolution computer images. As a result, a single system can handle a combination of computer images and protected content.

Enova DGX Switchers meet the HDCP Standard, which was established to prevent the unauthorized transfer of protected audiovisual content between devices. In addition, these switchers support InstaGate Pro, which was developed to address the special concerns that arise when protected content needs to be distributed.

Enova DGX HDMI Boards route HDCP (content-protected) and non-HDCP digital audiovisual signals. If HDCP is applied, the transmitted video is encrypted. The HDMI input connectors act as HDCP receivers (RXs) for upstream devices, and the output connectors act as HDCP transmitters (TXs) for downstream devices.

If the content is protected (HDCP), the Enova DGX Switcher functions as an InstaGate Pro sink and through the HDMI (or DVI) output connectors handles verification of the connected individual downstream sinks / destination devices (and downstream repeaters in the path if applicable). This means that the source device only needs to authenticate the HDMI input. Once the authentication is complete, the encrypted content begins to display on the destinations.

NOTE: *Enova DGX Boards do not support CEC.*

HDMI System Conditions

Normally, all devices used in an HDMI system are HDCP compliant. Each HDCP capable device has a unique set of confidential keys (used to encrypt and decrypt the data).

- Normally HDCP is used only when the source content is copyright protected. In some cases, source devices will always enforce HDCP even if the content is not protected. In those cases, when the source device sees that its output is connected to the input of the Enova DGX HDMI board (or another HDCP compliant sink), the source device will always enforce and encrypt the HDMI signal that it sends. If the system equipment includes this type of source device, be aware that DGX HDMI Boards will not be able to route that source device signal to a non-HDCP compliant display. Unprotected content is not affected and may be routed as desired.
- Each HDMI input can be routed to any number of outputs. The HDMI input (using InstaGate Pro Technology) is the only sink that the source device is required to verify (unless any repeaters are installed between the source device and the Enova DGX Switcher).
- Each HDMI output goes through a verification process with its connected sink(s).
If the connected downstream sink is not HDCP compliant, then the HDMI output will not send the signal. This does not affect other outputs the source may be routed to. This allows compliant displays to show content from source devices even if the source devices are switched to non-compliant displays. Non-compliant outputs can easily be identified because they display a dark red image to indicate they failed the authentication process.
- Each HDMI output can support a maximum of 16 devices (repeaters and destination devices) with seven levels, i.e., the number of times the signal goes through a repeater prior to going to the sink. However, if the HDMI output goes into a device which is also utilizing InstaGate Pro, then the process starts all over again and the Enova DGX Switcher only sees the input of that InstaGate Pro device as the one sink that it needs to verify. So even though the number of sinks each HDMI output on the switcher can handle is finite, the number of sinks can be unlimited if using AMX devices that support InstaGate Pro Technology.

Steps in the Content Protection Process

The content protection process for the point-to-point connection between the upstream transmitter on the source device and an HDMI input connector (which is an RX) on the Enova DGX Switcher through an HDMI output connector (which is a TX) to the destination device includes four steps:

1. The transmitter on the source device uses authentication protocol to verify that the HDMI input is authorized to receive the protected content. This is true regardless of how many destination devices the source is being routed to. The content is encrypted and transmitted.

- The Enova DGX Switcher verifies that the display devices are authorized to receive the protected content (this is the part of the process in which renewability of the SRM (System Renewability Message) list is verified; this verification of the display devices occurs inside the switcher). The content is encrypted and transmitted.
- The source device's transmitter periodically verifies that the HDMI input is still synchronized and capable of decrypting the protected content.
- The Enova DGX Switcher periodically verifies that the display devices are still synced and capable of decrypting the protected content.

If the source does not support HDCP, the display device does not need to support HDCP. The unencrypted content from the source is simply routed through the outputs to the display devices.

Supported Number of Sinks

HDCP Source Device

The number of sinks that the source device supports is not relevant when using Enova DGX Switcher boards that support HDCP because the input connector on the board is the only sink that the source device needs to authenticate.

Enova DGX Switcher

The HDMI outputs in an Enova DGX Switcher each support a maximum of 16 downstream devices (repeaters and/or destination devices).

Unsuccessful Transmission in System

If an Enova DGX Switcher does not successfully transmit the protected content to any of the routed sinks, it may indicate one of the following conditions:

- Non-compliant device – The sink device is not HDCP compliant or has had its authentication key revoked.

NOTE: *key revocation is handled strictly by the Enova DGX Switcher. The source does not take any action with respect to revoked keys.*
- HDMI output sink support limit exceeded – The output is actively routed to more than 16 downstream devices (display devices and/or repeaters) from a single output connector on an Enova DGX Switcher.

IMPORTANT: *Keep in mind that a "failure condition" (in which HDCP authentication fails to occur) is verified by the Enova DGX Switcher not the source device and will result in the image being a dark red.*

NOTE: *Most Blu-Ray players play all content (even un-encrypted content) as encrypted content. Normally the Enova DGX Switcher switches non-encrypted content without problems if the display is non-HDCP compliant. However, when encrypted content is sent from a Blu-Ray player to the Enova and is switched to a device that does not support HDCP, the content will not display and the image will be red.*

Video Troubleshooting

The following troubleshooting tips involve signal support from or to third-party devices.

Problem	Solution
<p>The HDMI Input Board does not pass video through the enclosure to a connected display.</p> <p>The likely cause is that the signal is from an incorrectly formatted source (e.g., VTC, wall processor with combined output, or signal generator) and the Enova DGX firmware (v1.6.4.1 and later) includes a background measurement process for detecting valid video.</p> <p>If the incoming signal fails to meet the Enova DGX criteria, it will not pass the signal.</p>	<p>Turn off the firmware's background checks and run video without them:</p> <ul style="list-style-type: none"> Install Enova DGX firmware v3.0.0.4 or later. Use the DGX_SHELL command set BCPux_bg_vsync_disabled=ON (where x is the input board slot number) to disable the background check (affects the entire input board). The command BCPux_bg_vsync_disabled=OFF enables the background check. <p>The video will route through the Enova DGX from source to destination as soon as the command is sent. The board's setting persists through power cycles and will persist the setting when removed from the enclosure and added to another, while a new board replacing the old board will be set to OFF (default).</p> <p>Note: <i>A complete list of the DGX_SHELL targets, BCPux, is in the "Product to Board Slot Correspondence" table on page 275.</i></p>
<p>Video from the HDMI Output Board to a third-party device (e.g., VTC, wall processor) does not display or displays with flickers.</p> <p>The problem is usually caused by destination devices with weak or no input equalization (i.e., the video stream from the output board attempts to lock onto the destination; however, the destination is unable to provide a stable connection). This is made worse when signals are passed through low-quality or long-distance cable runs.</p>	<p>Use one or more of the following work-around suggestions to avoid the issue:</p> <ul style="list-style-type: none"> Replace low quality cables with higher quality cables. Use shorter cable runs. Install an EDID emulator, an HDMI equalizer/repeater, or another device that rebuilds/re-clocks the signal. <p>You will know the problem is resolved when the video signal appears on the display device without flickering.</p>
<p>Intermittent or solid screen blanking after the video source is disconnected (VIDOUT_SLEEP is enabled).</p>	<p>For the video output attached to the problematic monitor, either uncheck the Allow Display Sleep option and set the Blank Color in the System Configuration interface (see page 184).</p> <p>Alternatively, set VIDOUT_SLEEP-DISABLE (page 221) and VIDOUT_BLANK-<color> (page 217).</p>

Audio Troubleshooting

Before troubleshooting audio, it helps to understand how the system handles EDID information.

- The source reads and adapts to the pre-loaded EDID on the DGX HDMI input connector.
- The factory default EDID is set to support 2 channel L-PCM audio. This EDID can be modified by using one of the methods described under "Possible Solutions" at the bottom of the page.

Problem	Solution
<p><i>Audio is not passing through the Enova DGX 100 Series Switcher, or is distorted.</i></p> <p>The default EDID for input boards only supports 2 channel L-PCM audio. If a source chooses to ignore this EDID and send a format that is not in the EDID, the audio may not pass through the Enova DGX 100 Series Switcher at all or it may be distorted.</p>	<p>To present other types of audio formats to the source, a different EDID must be loaded (see EDID configuration on page 140).</p> <p>If after changing the EDID on the input board, the audio is still distorted or is not present on the destination device, then the device may not be capable of supporting the requested audio format with the newly loaded EDID setting. In this case, a standard EDID should be used and the sources set up to only pass the type of audio that the downstream destination devices can handle.</p> <p>Note: One way to check if a destination supports a particular type of audio format is to capture the EDID using the System Configuration interface's Save EDID function and then paste the data from the .edid file into an EDID reader program (e.g., www.edidreader.com).</p> <p>If you encounter audio problems, we recommend trying the following solution:</p> <p>Use the EDID Save and Load functionality in the System Configuration interface (see page 141) to read the EDID from the destination device and to write it to the HDMI input on the Enova DGX Switcher.</p>
<p><i>Audio not present or intermittent with good video.</i></p> <p>A signal containing both video and audio must have space for both signal portions. The audio signal portion lies in the blanked portion of the video signal.</p> <p>High Bit Rate Audio (HBRA) requires a larger than normal space in the blanked area of the signal. Video formats with reduced blanking normally provide enough space for audio signals. In a signal that combines a video format with reduced blanking and HBRA, the HBRA signal is truncated and can present as either no audio or as problematic audio (static, clicking, absent, etc.).</p> <p>While Enova DGX hardware supports both HBRA and reduced blanking video formats, these formats do not necessarily work with one another.</p>	<p>Change either the audio format to non-HBRA or change the video format to a format that does not use reduced blanking.</p>

Audio Format Support on Enova DGX Boards

The following table indicates which audio formats are supported by specific Enova DGX boards.

Audio Format Support on Enova DGX Boards									
Audio Format	Board Types	HDMI / 4K HDMI Input Boards	HDMI Output Boards	DVI Input Boards	DVI Output Boards	DXLink Twisted Pair Input and Output Boards	DXLink Fiber Input and Output Boards	Audio Switching Boards (ASB and ASB-DAN)	Audio Insert/Extract Expansion Boards (on either the input or the output side)
2 Channel L-PCM		•	•	•	•	•	•	•	•
6 Channel L-PCM		•	•	•	•	•	•		
8 Channel L-PCM		•	•	•	•	•	•		
Dolby Digital		•	•	•	•	•*	•*		
DTS		•	•	•	•	•*	•*		
Dolby TrueHD		•		•		•	•		
DTS-HD Master		•		•		•	•		

* Dolby Digital and DTS support up to 48 kHz, 5.1 channels.

NOTE: DVI Boards must have their EDID changed to support HDMI signals with embedded audio.

IMPORTANT: Because signals are routed through HDMI, 4K HDMI, DVI, DXLink Twisted Pair, and DXLink Fiber Boards which feature SmartScale Technology, they normally produce a quality image. If the installation has special scaling, EDID, or HDCP requirements, see page 140.

DVI Input & Output Boards

Overview

This chapter pertains to the following DVI Input Board and Output Board for the Enova DGX Switcher:

- FG1058-600 Input board
- FG1058-610 Output board

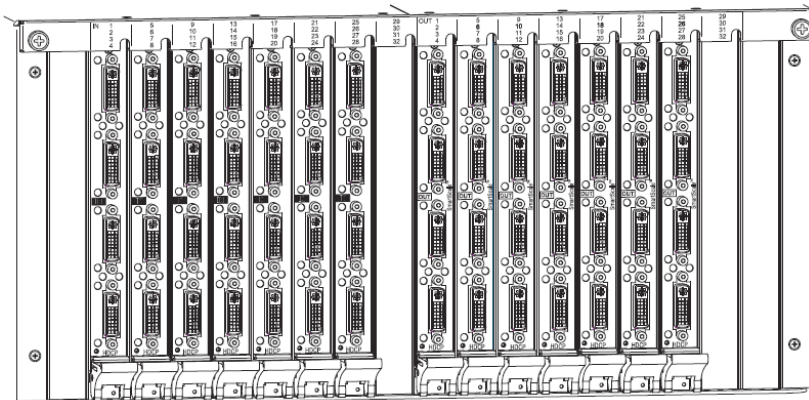

FIG. 40 Enova DGX DVI Input and DVI Output Boards

Enova DGX Enclosure Support for DVI Input & Output Boards	
DGX 800	Enova DGX 800 enclosures hold up to four DVI Boards with four inputs or outputs per board. Each enclosure holds a maximum of two input and two output boards, accommodating connector configurations up to a maximum of 8x8, as well as three subsets (i.e., 4x4, 4x8, or 8x4).
DGX 1600	Enova DGX 1600 enclosures hold up to eight DVI Boards with four inputs or outputs per board. Each enclosure holds a maximum of four input and four output boards, accommodating connector configurations up to a maximum of 16x16, as well as subsets (e.g., 16x8 or 4x12).
DGX 3200	Enova DGX 3200 enclosures hold up to sixteen DVI Boards with four inputs or outputs per board. Each enclosure holds a maximum of eight input and eight output boards, accommodating connector configurations up to a maximum of 32x32, as well as subsets in increments of four (e.g., 12x20 or 24x8).
DGX 6400	Enova DGX 6400 enclosures hold up to thirty-two DVI Boards with four inputs or outputs per board. Each enclosure holds a maximum of sixteen input and sixteen output boards, accommodating connector configurations up to a maximum of 64x64, as well as subsets in increments of four (e.g., 12x48 or 52x8).

Signal Routing

DGX DVI Input Boards route signals to DGX DVI Output Boards or to any other type of Enova DGX Output Boards. DVI Output Boards can also accept signals from all of the other types of Enova DGX Boards. When routing signals between different board types, the Enova DGX Switcher automatically converts the signal format to match the output board.

DGX DVI Boards can also accept HDMI/HDCP with embedded audio signals, but require an EDID change on the input board to allow a source device to send out signals in that format.

The DVI connectors are designed to route high-resolution DVI signals with or without HDCP (High-bandwidth Digital Content Protection). DVI Boards support only single link DVI-D signals. The connectors on the boards are DVI-I connectors, which allow use of cables with either single link DVI-D or DVI-I connectors (for DVI-I, the analog pins are not used; for DVI-I connector pinout information, see page 110).

NOTE: If the signal is HDMI formatted, DGX DVI Boards can also work in conjunction with AIE Boards (see page 175) or Audio Switching Boards (see page 164).

IMPORTANT: Signals through DVI Boards in the Enova DGX Switcher normally produce a quality image because the connectors are pre-loaded with the most common EDID settings to ensure they will work with the source devices. In addition to common EDIDs on the inputs, SmartScale on every output also greatly helps ensure that all signals are satisfactory. Therefore, adjustments are not necessary unless the installation has special scaling, EDID, or HDCP requirements. If re-programming of boards is necessary, use the System Configuration interface (see page 127).

InstaGate Pro and SmartScale

- DVI Boards meet HDCP Standards and support InstaGate Pro Technology. For information on HDCP functionality for DVI Boards, see "HDCP Support on Enova DGX Switchers" on page 98.
- DVI Input Boards provide EDID emulation support with plug-and-play information provided by the Enova DGX Switcher.
- DVI Output Boards feature SmartScale Technology which automatically responds to the preferred EDID information and scales the video to the best resolution and video settings for that display without manual setup.

- DVI Boards are HDCP 1.4 compatible and feature InstaGate Pro Technology for low-latency switching of HDCP protected content and support computer video up to 1920x1200 and HDTV up to 1080p. The EDID of the input will need to be changed to allow for HDMI formatted signals, so that the source device can send out that signal style. If the EDID on the input board has been properly modified and the downstream sink has proper declarations in its EDID, the DVI connectors also support embedded audio, both linear PCM (stereo audio) and non-linear PCM (Dolby Digital, Dolby TrueHD, DTS, etc.).

NOTE: InstaGate Pro Technology eliminates HDCP latency and interruptions on all displays in a system. (These conditions are typically experienced when HDCP authenticates HDMI source and destination devices.) key limitations on source devices are also eliminated by allowing them to see only a single sink key from the DVI Input Board's input connection. With InstaGate Pro Technology, when a source requires HDCP encrypted content, the inputs and compliant downstream devices are automatically authenticated - it just works.

NOTE: Enova DGX Boards do not support CEC.

Audio Support on DVI Boards

When DVI Boards are set up to support HDMI signals, the audio information in the HDMI Board chapter applies (see page 81).

Enova DGX DVI Boards - Specifications

Applies to input board FG1058-600 and output board FG1058-610.

Enova DGX DVI Boards - Specifications	
Compatible Formats	DVI, HDMI, HDCP
Signal Type	<ul style="list-style-type: none"> • DVI-D (single link with HDMI cable adapter) • HDMI • DisplayPort ++ (Input only, with HDMI cable adapter)
HDMI Mode Support	DVI Boards can be run in HDMI mode with an EDID update which will provide full HDMI functionality and board specifications
Video Data Rate (max.)	<ul style="list-style-type: none"> • 4.95 Gbps / 6.75 Gbps • 6.75 only supported when the HDMI Output Board Scaler or DXLink RX Scaler is in Bypass mode and format is 1080p60 or less with deep color
Video Pixel Clock (max.)	<ul style="list-style-type: none"> • 165 MHz / 225 MHz • 225 MHz only supported when the HDMI Output Board Scaler or DXLink RX Scaler is in Bypass mode and format is 1080p60 or less with deep color
Progressive Resolution Support	<ul style="list-style-type: none"> • 480p up to 1920x1200 @ 60 Hz • If the signal is interlaced, all scaled outputs will de-interlace video to a progressive resolution format. If in scaler Bypass mode, interlaced input will pass through unaltered.
Interlaced Resolution Support	<ul style="list-style-type: none"> • 480i, 576i, 1080i • If the signal is interlaced, all scaled outputs will de-interlace video to a progressive resolution format. If in scaler Bypass mode, interlaced input will pass through unaltered.
2K Resolution Support	<ul style="list-style-type: none"> • 2048x1024@47Hz; 2048x1080@60Hz; 2048x1152@60Hz; 2048x1536@24Hz • 2K formats are only compatible with DVI, HDMI, and DXLink Fiber Input/Output Boards and require the output scaler or RX Scaler to be set in Bypass mode
Input Equalization	<ul style="list-style-type: none"> • Adaptive up to 100 ft. (30 m) at 225 MHz • Cable distance support dependent on cable type and signal format.
Input Re-clocking (CDR)	Yes
Output Re-clocking	Yes
Output Scaling	SmartScale, Manual Configuration, Bypass
SmartScale Output Resolution Support	All resolutions between 480p and 1920x1200@60Hz via automatic SmartScale query of the preferred EDID Detailed Timing Definition
Deep Color Support	<ul style="list-style-type: none"> • 24-bit, 30-bit, 36-bit • 30-bit, 36-bit only supported when the HDMI Output Board Scaler or DXLink RX Scaler is in Bypass mode and format is 1080p60 or less
Color Space Support	<ul style="list-style-type: none"> • RGB 4:4:4 • YCbCr 4:4:4 and 4:2:2 • Input signal support for YCbCr 4:4:4 and 4:2:2, output color-space is converted to RGB 4:4:4
3D Format Support	HDMI primary formats (when used with DXLink Output Boards and the RX Scaler is in Bypass mode): <ul style="list-style-type: none"> • Frame Packing 1080p up to 24 Hz • Frame Packing 720p up to 50/60 Hz • Frame Packing 1080i up to 50/60 Hz • Top-Bottom 1080p up to 24 Hz • Top-Bottom 720p up to 50/60 Hz • Side-by-Side Half 1080i up to 50/60 Hz*
Audio Format Support	<ul style="list-style-type: none"> • Dolby TrueHD, Dolby Digital, DTS-HD Master Audio, DTS, 2 CH through 8 CH L-PCM • Dolby Digital and DTS support up to 48kHz, 5.1 channels
Audio Resolution	16 bit to 24 bit
Audio Sample Rate	32 kHz, 44.1 kHz, 48 kHz, 96 kHz, 192kHz
Local Audio Support	Insertion and/or extraction of 2 CH L-PCM selectable by channel

Digital Video- DVI Specifications (Cont.)	
DDC/EDID Support	<ul style="list-style-type: none"> EDID provided by the Enova DGX Digital Media Switcher EDID is user re-programmable Default has support for HDMI
HDCP Support	<ul style="list-style-type: none"> Full matrix HDCP support (includes any input to any or all outputs) key Management System AMX HDCP InstaGate Pro® Technology key support up to 16 devices per output, independent of source device
CEC Support	None
Input Voltage (nominal)	1.0 Vpp differential
Output Voltage (nominal)	1.0 Vpp differential
Output Rise Time / Fall Time	<ul style="list-style-type: none"> 100 ps min. to 200 ps max. (20% to 80%) 0.16 UI min. to 0.33 UI max. (@ 1.65 Gbps, 20% to 80%)
Output +5 V DDC Pin	50 mA per output port
Input Board Propagation Delay	2 μ s
Output Board Propagation Delay	24 ms for progressive, 48 ms for interlaced, 5 μ s when in Bypass mode
HDMI Audio Synchronization (Embedded Audio)	Progressive and Interlaced Video Formats @ 60 Hz frame rate: Audio is actively delayed to match video within 8 ms leading or lagging Note: Interlaced and progressive video supported into the HDMI Input Board, progressive only supported out of the HDMI Output Board unless in non-scaling Bypass mode.
HDMI Audio Synchronization (Switched Audio)	Progressive and Interlaced Video Formats @ 60Hz frame rate: Audio lags video by up to 22ms.
Audio switching Board Support	Supports break-away audio switching of 2 CH L-PCM for all channels and down-mix Dolby True-HD, Dolby Digital, DTS-HD or DTS for one input channel
Connector	4 DVI-I ports (DVI-D single link is the supported signal type)

NOTE: Interlaced and progressive video are supported into the HDMI Input Board; progressive video is only supported out of the HDMI Output Board, unless in non-scaling bypass mode.

EDID Resolutions Supported through Local DDC

NOTE: This section covers all of the default EDIDs. In the System Configuration interface, the EDIDs contained in this section's tables are displayed in a single dropdown menu (General section, Preferred EDID menu).

Standard Timings (Default shipping EDID)

NOTE: The default EDID can be overwritten to include a broad range of features, including HDMI mode, based on installation requirements.

Resolution	Refresh Rate Max.
1920x1080 (Preferred timing identified in the EDID)	60 Hz
1920x1200	60 Hz
1680x1050	60 Hz
1600x1200	60 Hz
1600x900	60 Hz
1400x1050	60 Hz
1440x900	60 Hz
1360x765	60 Hz
1280x1024	60 Hz
1280x900	60 Hz
1280x800	60 Hz
1280x720	60 Hz

Established Timings

Resolution	Refresh Rate Max.
1280x1024	75 Hz
1152x870	75 Hz
1024x768	60 Hz, 70 Hz, 75 Hz, 87 Hz
832x624	75 Hz
800x600	56 Hz, 60 Hz, 72 Hz, 75 Hz
720x400	70 Hz, 88 Hz
640x480	60 Hz, 67 Hz, 72 Hz, 75 Hz

CTA Video Information Code (VIC) Formats

VIC #	Resolution	Refresh Rate and Aspect Ratio
VIC = 1	640x480p	59.94/60 Hz 4:3
VIC = 2	720x480p	59.94/60 Hz 4:3
VIC = 3	720x480p	59.94/60 Hz 16:9
VIC = 4	1280x720p	59.94/60 Hz 16:9
VIC = 5	1920x1080i	59.94/60 Hz 16:9
VIC = 6	720(1440)x480i	59.94/60 Hz 4:3
VIC = 7	720(1440)x480i	59.94/60 Hz 16:9
VIC = 14	1440x480p	59.94/60 Hz 4:3
VIC = 15	1440x480p	59.94/60 Hz 16:9
VIC = 16	Native 1920x1080p	59.94/60 Hz 16:9
VIC = 17	720x576p	50 Hz 4:3
VIC = 18	720x576p	50 Hz 16:9
VIC = 19	1280x720p	50 Hz 16:9
VIC = 20	1920x1080i	50 Hz 16:9
VIC = 21	720(1440)x576i	50 Hz 4:3
VIC = 22	720(1440)x576i	50 Hz 16:9
VIC = 29	1440x576p	50 Hz 4:3
VIC = 30	1440x576p	50 Hz 16:9
VIC = 31	1920x1080p	50 Hz 16:9
VIC = 32	1920x1080p	23.97/24 Hz 16:9
VIC = 33	1920x1080p	25 Hz 16:9
VIC = 34	1920x1080p	29.97/30 Hz 16:9
VIC = 39	1920x1080i	50 Hz 16:9
VIC = 41	1280x720p	100 Hz 16:9
VIC = 42	720x576p	100 Hz 4:3
VIC = 43	720x576p	100 Hz 16:9
VIC = 44	720(1440)x576i	100 Hz 4:3
VIC = 45	720(1440)x576i	100 Hz 16:9
VIC = 47	1280x720p	119.88/120 Hz 16:9
VIC = 48	720x480p	119.88/120 Hz 4:3
VIC = 49	720x480p	119.88/120 Hz 16:9

NOTE: The Consumer Technology Association (CTA) was formerly known as the Consumer Electronics Association (CEA); the CEA 861 video standard has been renamed to CTA 861.

Audio Data Block

Channels	Sampling Frequency
Basic Audio: 2 channel L-PCM 32, 44.1, 48 kHz	Sampling frequency at 16, 20, or 24 bits per sample

IMPORTANT: For information on troubleshooting audio, including a table on "Audio Format Support on Enova DGX Boards," see page 111.

Connecting DVI Inputs and Outputs

Fasten the DVI-I (or DVI-D) connectors on the cable ends onto the DVI-I receptacles on the boards.

IMPORTANT: Screw down the DVI connector retention screws to secure the plug and ensure a good connection.

DVI Pinout

Pinout information for the DVI-I connector on the DVI Input and Output Boards is listed in the table below:

DVI-I Pinout			
1. Data 2-	9. Data 1-	17. Data 0-	C1. No connect
2. Data 2+	10. Data 1+	18. Data 0+	C2. No connect
3. Ground	11. Ground	19. Ground	C3. No connect
4. No connect	12. No connect	20. No connect	C4. No connect
5. No connect	13. No connect	21. No connect	C5. No connect
6. DDC-CLK	14. +5 V*	22. Ground	
7. DDC-Data	15. Ground	23. CLK+	
8. No connect	16. Hot-Detect	24. CLK-	

* DVI output pin 14 (+5 VDC out) supplies 50 mA per each of the four output connectors.



Troubleshooting Video

The following troubleshooting tips both involve signal support from or to third-party devices:

Problem	Solution
<p><i>The DVI Input Board does not pass video through the enclosure to a connected display.</i></p> <p>The likely cause is that the signal is from an incorrectly formatted source (e.g., VTC, wall processor with combined output, or signal generator) and the Enova DGX firmware (v1.6.4.1 and later) includes a background measurement process for detecting valid video. If the incoming signal fails to meet the Enova DGX criteria, it will not pass the signal.</p>	<p>Turn off the firmware's background checks and run video without them:</p> <ul style="list-style-type: none"> • Install Enova DGX firmware v3.0.0.4 or later. • Use the DGX_SHELL command set BCPux_bg_vsync_disabled=ON (where x is the input board slot number) to disable the background check (affects the entire input board). The command BCPux_bg_vsync_disabled=OFF enables the background check. <p>The video will route through the Enova DGX from source to destination as soon as the command is sent.</p> <p>The board's setting persists through power cycles and will persist the setting when removed from the enclosure and added to another, while a new board replacing the old board will be set to OFF (default).</p> <p>Note: A complete list of the DGX_SHELL targets, BCPux, is in the "Product to Board Slot Correspondence" table on page 275.</p>
<p><i>Video from the DVI Output Board to a third-party device (e.g., VTC, wall processor) does not display or displays with flickers.</i></p> <p>The problem is usually caused by destination devices with weak or no input equalization (i.e., the video stream from the output board attempts to lock onto the destination; however, the destination is unable to provide a stable connection). This is made worse when signals are passed through low-quality or long-distance cable runs.</p>	<p>Use one or more of the following work-around suggestions to avoid the issue:</p> <ul style="list-style-type: none"> • Replace low quality cables with higher quality cables. • Use shorter cable runs. • Install an EDID emulator, an HDMI equalizer/repeater, or another device that rebuilds/re-clocks the signal. <p>You will know the problem is resolved when the video signal appears on the display device without flickering.</p>

Troubleshooting Audio

Before troubleshooting audio, it helps to understand how the system handles EDID information.

- The source reads and adapts to the pre-loaded EDID on the board's input connector.
- The factory default EDID is set to support 2 channel L-PCM audio. This EDID can be modified by using one of the methods described under "Possible Solutions" on the following page.

Audio Format Support on Enova DGX Boards

The following table indicates which audio formats are supported by specific Enova DGX boards.

Audio Format Support on Enova DGX Boards									
Audio Format	Board Types	HDMI Input Boards	HDMI Output Boards	DVI Input Boards	DVI Output Boards	DXLink Twisted Pair I/O Boards	DXLink Fiber I/O Boards	Audio Switching Boards (ASB and ASB-DAN)	Audio Insert/Extract Expansion Boards (on either the input or the output side)
2 Channel L-PCM		•	•	•	•	•	•	•	•
6 Channel L-PCM		•	•	•	•	•	•	•**	
8 Channel L-PCM		•	•	•	•	•	•	•**	
Dolby Digital		•	•	•	•	•*	•*	•**	
DTS		•	•	•	•	•*	•*	•**	
Dolby TrueHD		•		•		•	•	•**	
DTS-HD Master		•		•		•	•	•**	
		* Dolby Digital and DTS support up to 48 kHz, 5.1 channels. ** ASB Boards support 1 down-mix input channel.							

IMPORTANT: Because signals are routed through HDMI, DVI, DXLink Twisted Pair, and DXLink Fiber Boards which feature SmartScale Technology, they normally produce a quality image. If the installation has special scaling, EDID, or HDCP requirements, see page 140.

Problem	Solution
<p>The default EDID for input boards only supports 2 channel L-PCM audio. If a source chooses to ignore this EDID and send a format that is not in the EDID, the audio may not pass through the Enova DGX 100 Series Switcher at all or it may be distorted.</p> <p>To present other types of audio formats to the source, a different EDID must be loaded. If after changing the EDID on the input board, the audio is still distorted or is not present on the destination device, then the device may not be capable of supporting the requested audio format with the newly loaded EDID setting. In this case, a standard EDID (2 Channel L-PCM) should be used and the sources set up to only pass the type of audio that the downstream destination devices can handle.</p> <p>The AMX EDID Library is available at www.amx.com (search for EDID Library).</p>	<p>Checking for Support: One way to check if a destination supports a particular type of audio format is to capture the EDID using the System Configuration interface's Save EDID function and then paste the data from the .edid file into an EDID reader program (e.g., www.edidreader.com).</p> <p>If you encounter audio problems, we recommend trying the following solution:</p> <p>Use the EDID Save and Load functionality in the System Configuration interface (see page 141) to read the EDID from the destination device and to write it to the HDMI input on the Enova DGX Switcher.</p>
<p>Audio not present or intermittent with good video.</p> <p>A likely cause is that signal containing both video and audio must have space for both signal portions. The audio signal portion lies in the blanked portion of the video signal.</p> <p>High Bit Rate Audio (HBRA) requires a larger than normal space in the blanked area of the signal. Video formats with reduced blanking normally provide enough space for audio signals. In a signal that combines a video format with reduced blanking and HBRA, the HBRA signal is truncated and can present as either no audio or as problematic audio (static, clicking, absent, etc.).</p> <p>While Enova DGX hardware supports both HBRA and reduced blanking video formats, these formats do not necessarily work with one another.</p>	<p>Change either the audio format to non-HBRA or change the video format to a format that does not use reduced blanking.</p>

DXLink Twisted Pair Input and Output Boards

Overview

This chapter pertains to Enova DGX DXLink™ Twisted Pair Input and Output Boards:

- FG1058-570 Input board
- FG1058-580 Output board

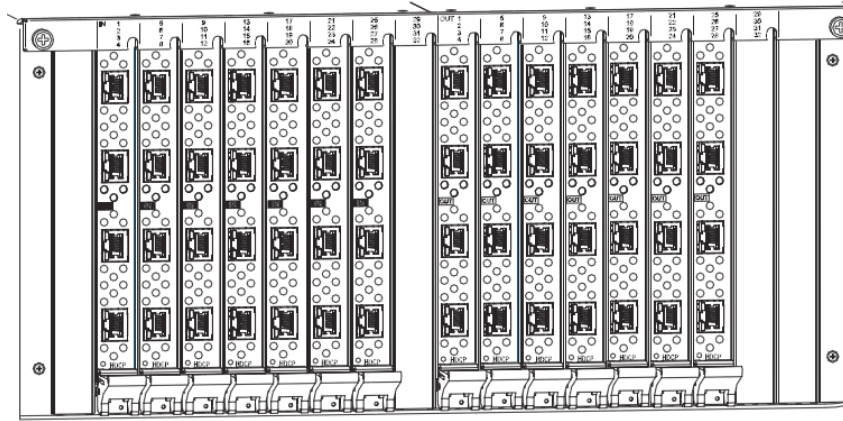

FIG. 41 DXLink Twisted Pair Input and Output Boards

Enova DGX Enclosure Support for DXLink Twisted Pair Boards	
DGX 800	Enova DGX 800 enclosures can hold up to four DXLink Boards with four RJ-45 inputs or outputs per board. Each enclosure holds a maximum of two input and two output boards, accommodating connector configurations up to a maximum of 8x8, as well as three subsets (i.e., 4x4, 4x8, or 8x4).
DGX 1600	Enova DGX 1600 enclosures can hold up to eight DXLink Boards with four RJ-45 inputs or outputs per board. Each enclosure holds a maximum of four input and four output boards, accommodating connector configurations up to a maximum of 16x16, as well as subsets (e.g., 16x8 or 4x12).
DGX 3200	Enova DGX 3200 enclosures can hold up to sixteen DXLink Boards with four RJ-45 inputs or outputs per board. Each enclosure holds a maximum of eight input and eight output boards, accommodating connector configurations up to a maximum of 32x32, as well as subsets (e.g., 12x24 or 32x8).
DGX 6400	Enova DGX 6400 enclosures can hold up to thirty-two DXLink Boards with four RJ-45 inputs or outputs per board. Each enclosure holds a maximum of sixteen input and sixteen output boards, accommodating connector configurations up to a maximum of 64x64, as well as subsets (e.g., 12x48 or 52x8).

IMPORTANT: DXLink™ Twisted Pair Boards must be used in conjunction with DXLink™ Twisted Pair Transmitters and Receivers or other AMX DXLink™ signal management solutions.

NOTE: Compatibility is available between DXLink Twisted Pair equipment and DXLink Twisted Pair 4K equipment (see the "DXLink Compatibility" Appendix in the "DXLink Twisted Pair 4K Transmitters and Receivers Hardware Reference Manual" at www.amx.com).

Signal Routing

DXLink Twisted Pair Input Boards route signals to DXLink Output Boards or to any other type of Enova DGX Output Boards. DXLink Twisted Pair Output Boards can also accept signals from all of the other types of Enova DGX Boards. When routing signals between different board types, the Enova DGX Switcher automatically converts the signal format to match the output board.

Signals that can be sent over DXLink Boards include: HDMI, DVI-D, analog video, analog audio, digital audio, and embedded audio. DXLink Boards also work in conjunction with Audio Switching Boards (see page 171) or Audio Insert/Extract Boards (see page 183).

IMPORTANT: Because the DXLink, DVI, and HDMI Boards in the Enova DGX Switcher normally produce a quality image, you will not need to make adjustments or custom scaler settings unless the installation has special scaling, EDID, or HDCP requirements (if adjustments are necessary, use the System Configuration interface; see page 127).

NOTE: Enova DGX DXLink Boards do not support CEC.

HDCP Compliance

If a connected downstream sink is not HDCP compliant, then the DXLink output will not send the signal to it. This does not affect other outputs the source may be routed to. This allows compliant displays to show content from source devices even if the source devices are switched to non-compliant displays. Non-compliant displays can easily be identified because they display a dark red image (via an HDMI/DVI Output) or an orange image (via a DXLink RX) to indicate that the authentication process failed.

InstaGate Pro Technology

- DXLink Boards meet HDCP standards and support InstaGate Pro Technology. For information on HDCP functionality for DXLink boards, see "HDCP Support on Enova DGX Switchers" on page 103.
- DXLink Boards provide EDID emulation support with plug-and-play information provided by the Enova DGX Switcher.
- DXLink input and output connectors incorporate HDMI Technology, are HDCP 1.4 compatible, and feature InstaGate Pro Technology for low-latency switching of HDCP protected content and support computer video up to 1920x1200 and HDTV up to 1080p. The DXLink connectors also support embedded audio, both linear PCM (stereo audio) and non-linear PCM (Dolby Digital, Dolby TrueHD, DTS, etc.).

DXLink - Twisted Pair Boards Specifications

Applies to input board FG1058-570 (DGX-I-DXL) and output board FG1058-580 (DGX-O-DXL).

NOTE: Compatibility is available between DXLink Twisted Pair equipment and DXLink Twisted Pair 4K equipment (see the "DXLink Compatibility" Appendix in the "DXLink Twisted Pair 4K Transmitters and Receivers Hardware Reference Manual" at www.amx.com).

Compatible AMX DXLink - Twisted Pair Transmitters and Receiver

- DXLink Multi-Format TX: FG1010-310 (DX-TX)
- DXLink Multi-Format Wallplate TX: FG1010-320-BL (DX-TX-WP-BL)
- DXLink Multi-Format Wallplate TX: FG1010-320-WH (DX-TX-WP-WH)
- DXLink Multi-Format Decor Style Wallplate TX (US): FG1010-325-BL (DX-TX-DWP-BL)
- DXLink Multi-Format Decor Style Wallplate TX (US): FG1010-325-WH (DX-TX-DWP-WH)
- DXLink HDMI RX: FG1010-500 (DX-RX)

NOTE: The Receiver features SmartScale Technology and is also compatible with the DXLink output connections on Enova DVX Solutions.

Compatible AMX Solecis Digital Switchers (1 Output per Switcher)

- Solecis 4x1 HDMI Digital Switcher with DXLink Output
- Solecis 5x1 Multi-Format Digital Switcher with DXLink Output
- Solecis 8x1 HDMI Digital Switcher with DXLink Output

IMPORTANT: DXLink twisted pair cable runs for DXLink equipment shall only be run within a common building. "Common building" is defined as: Where the walls of the structure(s) are physically connected and the structure(s) share a single ground reference.

DXLink Twisted Pair Input and Output Boards - Specifications	
Compatible DXLink Products	Multi-Format TX, Multi-Format Wallplate TX, Decor Wallplate TX, and DXLink RX; and other AMX DXLink signal management products
Compatible Formats	HDMI video, audio, Ethernet, USB (HID), power, and control
Signal Type Support	DXLink Twisted Pair
Transport Layer Throughput (max.)	10.2 Gbps
Video Data Rate (max.)	4.95 Gbps / 6.75 Gbps Note: Only supported when the HDMI Output Board Scaler or DXLink RX scaler is in Bypass mode and format is 1080p 60 Hz or less.
Video Pixel Clock (max.)	165 MHz / 225 MHz Note: Only supported when the HDMI Output Board Scaler or DXLink RX scaler is in Bypass mode and format is 1080p 60 Hz or less.
Progressive Resolution Support	480p up to 1920x1200,60Hz
Interlaced Resolution Support*	480i, 576i, 1080i
Deep Color Support	24-bit, 30-bit, 36-bit Note: 30 and 36-bit only supported when the HDMI Output Board Scaler or DXLink RX scaler is in Bypass mode and format is 1080p 60 Hz or less.
Color Space Support	<ul style="list-style-type: none"> • RGB 4:4:4 • YCbCr 4:4:4 and 4:2:2 Note: Input signal support for YCbCr 4:4:4 and 4:2:2, output color-space is converted to RGB 4:4:4.
3D Format Support	HDMI primary formats, when used with DXLink Output Boards and the RX Scaler is in Bypass mode <ul style="list-style-type: none"> • Frame Packing 1080p up to 24 Hz • Frame Packing 720p up to 50/60 Hz • Frame Packing 1080i up to 50/60 Hz • Top-Bottom 1080p up to 24 Hz • Top-Bottom 720p up to 50/60 Hz • Side-by-Side Half 1080i up to 50/60 Hz
Audio Format Support	Dolby TrueHD, Dolby Digital*, DTS-HD Master Audio, DTS*, 2 CH L-PCM, 6 CH L-PCM, 8 CH L-PCM Note: Dolby Digital and DTS support up to 48 kHz, 5.1 channels.
Audio Resolution	16 bit to 24 bit

Enova DGX DXLink Twisted Pair Board - Specifications (Cont.)	
Audio Sample Rate	32 kHz, 44.1 kHz, 48 kHz, 96 kHz, 192 kHz
Local Audio Support	Insertion and/or extraction of 2 CH L-PCM selectable by channel.
EDID Support	<ul style="list-style-type: none"> EDID provided by Enova DGX Digital Media Switcher to the digital (HDMI) input on the DXLink Multi-Format TX EDID is user re-programmable
HDCP Support	<ul style="list-style-type: none"> Full matrix HDCP support (includes any input to any or all outputs) key Management System AMX HDCP InstaGate Pro Technology key support up to 16 destinations per output, independent of source device
CEC Support	None
ICSP, TCP/IP, USB, IR, and Control Management	Control Distribution is managed by the Enova DGX Digital Media Switcher on-board NetLinx NX Master and Ethernet Switch.
USB (HID) Transport	Use the Enova DGX Digital Media Switcher in conjunction with DXLink Transmitters and Receivers (twisted pair and/or fiber), connect a DXLink Transmitter to a PC and a DXLink Receiver to a keyboard and mouse, the system then emulates commands from the receiver back to the PC. Note: A list is available of HID devices which have been tested and found to be working well with the latest firmware (see "DXLink -HID supported Devices" on the DXLink Receiver's product page at www.amx.com).
DXLink Twisted Pair Power	DXLink Twisted Pair Transmitters and Receivers can have power supplied over twisted pair cable when connected to a DXLink Input or Output Board on the Enova DGX Digital Media Switcher
Input Board Propagation Delay	5 μ s
Output Board Propagation Delay	5 μ s
Audio Switching Board Support	Supports break-away audio switching of 2 CH L-PCM for all channels and down-mix Dolby True-HD, Dolby Digital, DTS-HD or DTS for one input channel.
Connectors	4 RJ-45 ports
Twisted Pair Cable Type	Shielded Cat6, Cat6A, Cat7 Note: For more details and helpful cabling information, reference the white paper titled "Cabling for Success with DXLink" available at www.amx.com or contact your AMX representative.
Twisted Pair Cable Length	Up to 328 ft. (100 m) Note: For more details and helpful cabling information, reference the white paper titled "Cabling for Success with DXLink" available at www.amx.com or contact your AMX representative.
Important Notice	DXLink twisted pair cable runs for DXLink equipment shall only be run within a common building. Note: A "Common building" is a building in which the walls of the structure(s) are physically connected and the structure(s) share a single ground reference.

EDID Resolutions Supported through Local DDC

This section covers all of the default EDIDs. In the System Configuration interface, the EDIDs contained in this section's tables are displayed in a single dropdown menu (General section, Preferred EDID menu) and VICs are differentiated by the presence of a "p" or "i" in the format. Standard and established timings are given in the tables following along with detailed timing blocks.

IMPORTANT: The EDID can be configured to support additional resolutions through the local DDC using the EDID options in the System Configuration interface (see page 140).

NOTE: The Consumer Technology Association (CTA) was formerly known as the Consumer Electronics Association (CEA): the CEA 861 video standard has been renamed to CTA 861.

Standard Timings (Default Shipping EDID)

NOTE: The default EDID can be overwritten to include a broad range of features, based on installation requirements.

Resolution	Refresh Rate Max	
1920x1080	60 Hz	Preferred timing (identified in the EDID)
1920x1200	60 Hz	
1680x1050	60 Hz	
1600x1200	60 Hz	
1600x900	60 Hz	
1400x1050	60 Hz	
1440x900	60 Hz	
1360x765	60 Hz	
1280x1024	60 Hz	
1280x900	60 Hz	
1280x800	60 Hz	
1280x720	60 Hz	

Established Timings

Resolution	Refresh Rate Max.
1280x1024	75 Hz
1152x870	75 Hz
1024x768	60 Hz, 70 Hz, 75 Hz, 87 Hz
832x624	75 Hz
800x600	56 Hz, 60 Hz, 72 Hz, 75 Hz
720x400	70 Hz, 88 Hz
640x480	60 Hz, 67 Hz, 72 Hz, 75 Hz

NOTE: Audio problems may result from passing Dolby or DTS or high PCM frequency rates to a destination device that does not support them. Video problems may result from passing a video format that the destination device does not support. In either of these cases, re-programming the EDID may help resolve the problem.

CTA Video Information Code (VIC) Formats

VIC #	Resolution	Refresh Rate and Aspect Ratio
VIC = 1	640x480p	59.94/60 Hz 4:3
VIC = 2	720x480p	59.94/60 Hz 4:3
VIC = 3	720x480p	59.94/60 Hz 16:9
VIC = 4	1280x720p	59.94/60 Hz 16:9
VIC = 5	1920x1080i	59.94/60 Hz 16:9
VIC = 6	720(1440)x480i	59.94/60 Hz 4:3
VIC = 7	720(1440)x480i	59.94/60 Hz 16:9
VIC = 14	1440x480p	59.94/60 Hz 4:3
VIC = 15	1440x480p	59.94/60 Hz 16:9
VIC = 16	Native 1920x1080p	59.94/60 Hz 16:9
VIC = 17	720x576p	50 Hz 4:3
VIC = 18	720x576p	50 Hz 16:9
VIC = 19	1280x720p	50 Hz 16:9
VIC = 20	1920x1080i	50 Hz 16:9
VIC = 21	720(1440)x576i	50 Hz 4:3
VIC = 22	720(1440)x576i	50 Hz 16:9
VIC = 29	1440x576p	50 Hz 4:3
VIC = 30	1440x576p	50 Hz 16:9
VIC = 31	1920x1080p	50 Hz 16:9
VIC = 32	1920x1080p	23.97/24 Hz 16:9
VIC = 33	1920x1080p	25 Hz 16:9
VIC = 34	1920x1080p	29.97/30 Hz 16:9
VIC = 39	1920x1080i	50 Hz 16:9
VIC = 41	1280x720p	100 Hz 16:9
VIC = 42	720x576p	100 Hz 4:3
VIC = 43	720x576p	100 Hz 16:9
VIC = 44	720(1440)x576i	100 Hz 4:3
VIC = 45	720(1440)x576i	100 Hz 16:9
VIC = 47	1280x720p	119.88/120 Hz 16:9
VIC = 48	720x480p	119.88/120 Hz 4:3
VIC = 49	720x480p	119.88/120 Hz 16:9

Audio Data Block

Channels	Sampling Frequency
Basic Audio: 2 channel L-PCM 32, 44.1, 48 kHz	Sampling frequency at 16, 20, or 24 bits per sample

IMPORTANT: For information on troubleshooting audio, including a table on "Audio Format Support on Enova DGX Boards," see page 101.

System Setup with DXLink Transmitters and Receivers

DXLink Twisted Pair Input and Output Boards must be used in conjunction with AMX DXLink Transmitters and Receivers or other AMX DXLink signal management solutions. This combination creates an end-to-end extender solution for transmission of HDMI (or DVI via adapter cable) over twisted pair cable. In addition to transport of HDMI, the DXLink Transmitters and Receivers provide Native NetLinX control functionality (Ethernet connectivity, IR control, and serial data transfer).

NOTE: *DXLink wallplate models do not support IR control or serial data transfer.*

The DXLink Multi-Format TX, DXLink Multi-Format Wallplate TX, and DXLink Decor Wallplate TX also have an input for analog video (composite, Y/C, Y/Pb/Pr, RGB, RGBS, or RGBHV).

- Compatible DXLink Transmitters and Receivers are listed on page 113.
- System setup options are listed in the table below.
- For TX and RX installation details, see the Transmitter and Receiver's *Quick Start Guide* or *Hardware Reference Manual*.

When the Transmitters and Receivers are installed in conjunction with the DXLink Boards, image adjustment and EDID scaling is automatically applied. For almost every installation, the automatic features on the Transmitters and Receivers result in a quality image on the monitor.

If the installation has special requirements and needs additional adjustment, see page 127. If you need additional information on the Transmitters and Receivers or their specifications, refer to the *Hardware Reference Manual – DXLink Twisted Pair Transmitters/Receiver* at www.amx.com.

The distance from a DXLink Transmitter to a DXLink Input Board can be up to 328 feet (100 m) and another 328 feet (100 m) from the DXLink Output Board to the DXLink Receiver.

IMPORTANT: *DXLink twisted pair cable runs for DXLink Input and Output Boards shall only be run within a common building. "Common building" is defined as: Where the walls of the structure(s) are physically connected and the structure(s) share a single ground reference.*

NOTE: *Along with the video signal, the DXLink Boards support embedded digital audio and analog stereo audio from the DXLink Transmitters and Receiver.*

Options for DXLink System Setup

The following table contains several options in an Enova DGX Switcher for using DXLink Input and/or Output Boards in conjunction with DXLink Transmitters and Receivers.

System Setup Options - Enova DGX Boards with DXLink Modules/Wallplates			
DXLink Module/Wallplate	Enova DGX Input Board	Enova DGX Output Board	DXLink Module
Multi-Format TX Module →	DXLink Twisted Pair →	DXLink Twisted Pair →	HDMI RX Module
Multi-Format TX Module →	DXLink Twisted Pair →	Any output board →	Not applicable
Multi-Format Wallplate TX →	DXLink Twisted Pair →	DXLink Twisted Pair →	HDMI RX Module
Multi-Format Wallplate TX →	DXLink Twisted Pair →	Any output board →	Not applicable
Decor Wallplate TX →	DXLink Twisted Pair →	DXLink Twisted Pair →	HDMI RX Module
Decor Wallplate TX →	DXLink Twisted Pair →	Any output board →	Not applicable
Not Applicable	Any input board → *	DXLink Twisted Pair →	HDMI RX Module

- * If the board is a DXLink Fiber Board, it will need the appropriate Transmitter or Receiver; see the table on page 46.
- DXLink Transmitters and Receivers can be also be used together as a standalone solution without a switcher (wallplate models connected directly to a DXLink HDMI RX **must** use a DXLink power injector); see the "Hardware Reference Manual – DXLink Twisted Pair Transmitters/Receiver."
 - Solecis Digital Switchers have a DXLink Twisted Pair output port that optionally provides source point switching and distance transmission to an Enova DGX DXLink Twisted Pair Input Board for hub-style or campus-wide distribution.

IMPORTANT: *Before connecting a Solecis Digital Switcher to a DXLink Twisted Pair Input Board in an Enova DGX 100 Series Digital Media Switcher, both the Solecis unit and all DXLink Twisted Pair boards must be upgraded with the latest available firmware versions. Solecis units **must** be upgraded before connecting a unit to an upgraded input board.*

DXLink Transmitter/Receiver Grounding

When using DXLink Power from an Enova DGX Switcher, we recommend wiring a technical ground for the ungrounded sources/destinations with respect to the DXLink Transmitters/Receivers and switcher. For complete grounding information, see the *Hardware Reference Manual – DXLink Twisted Pair Transmitters/Receiver*.

IMPORTANT: *If one DXLink Transmitter or Receiver is grounded, any remaining ungrounded units that are connected to the same board on the Enova DGX Switcher must also be grounded.*

Example of Typical Setup with DXLink Transmitter and Receiver

A typical system setup for a source and a destination is illustrated below and shows an Enova DGX 1600 with DXLink Boards used in conjunction with DXLink Transmitters and Receivers for transport of HDMI signals. This type of setup also supports DVI-D signals with the use of a cable adapter and analog video through a Multi-Format TX, Wallplate TX, or Decor Wallplate TX.

The Transmitter receives an HDMI signal and an audio signal from a source device. The audio can be either digital audio embedded with the HDMI signal, digital audio over S/PDIF, or analog stereo audio. Both the video and embedded audio are transmitted over twisted pair cable to the RJ-45 connector on the DXLink Input Board. The signal is routed through the desired DXLink Output connector to the DXLink Receiver, which in turn sends the HDMI signal with embedded audio on to a destination device. Audio (whether embedded or not) received on the Transmitter can be output on the stereo audio port (page 117):

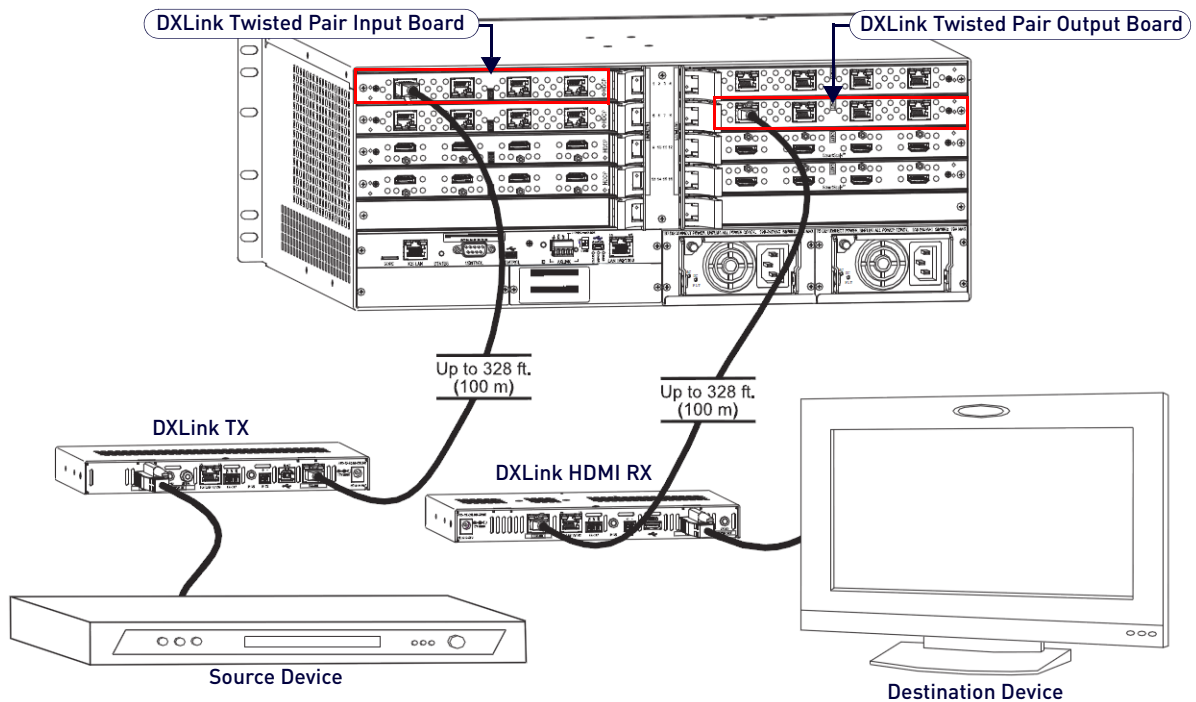

FIG. 42 DXLink Boards used in conjunction with DXLink Transmitter and Receiver

NOTE: For systems with special requirements – Before installing in the final location, place the equipment close together, so a PC for control and the destination monitor can be seen simultaneously if adjustments are necessary. Adjustments can be made using the System Configuration interface (see page 127).

Functions of DXLink Transmitters and Receivers

FIG. 43 shows the functions of DXLink Transmitters and Receivers and the example descriptions contain the device HDCP key count when used in conjunction with DXLink Boards in an Enova DGX Digital Media Switcher:

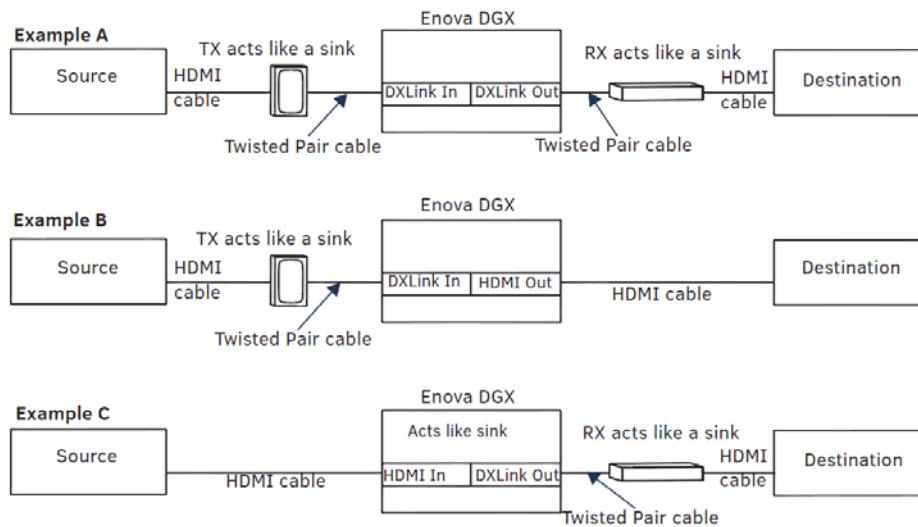

FIG. 43 Repeater and source functions of Transmitters and Receivers (A and B also apply to TX wallplate models)

- **Example A:** When a Receiver acts like a source, its key does not count. Source device sees 1 key (Transmitter).
- **Example B:** When a Transmitter acts like a sink, the source device sees 1 key (Transmitter).
- **Example C:** When a source device is connected directly to a switcher, the source sees 1 key (switcher input).

Important Power Considerations for Enova DGX 3200 Endpoint Systems

NOTE: This section *does not* apply to the Enova DGX 800/1600/6400 because the system is capable of providing power for the maximum number of DXLink Transmitters and Receivers required when the enclosure contains all DXLink Twisted Pair Input and Output boards.

In an endpoint system, the Enova DGX Switcher has DXLink Transmitters and/or Receivers attached. The Transmitters and Receivers can be powered either locally, remotely, or via the switcher (the last two ways are considered DXLink power since power is received via the DXLink line).

- Local power – Local power on a DXLink Transmitter or Receiver always takes precedence over power via the DXLink line from the switcher. However, if a locally powered Module is connected to a switcher and the local power is lost (i.e., unplugged or turned off), the Module will power down and then automatically power back up using power from the switcher via the DXLink connection (increasing the overall power draw on the switcher). When local power is restored, it automatically replaces the power over the DXLink line.
- DXLink power – When DXLink Transmitters or Receivers are being powered by an Enova DGX DXLink board or DXLink power injector (using power via the DXLink line), to maintain the switcher's power redundancy, we recommend that you:

Determine the power budget based on the input/output boards used and the quantity of powered endpoints (DXLink Modules and Wallplates); see the following page.

Do not use the local DC power jack on the Module (even if the local power adapter is off).

NOTE: AMX supports the use of DXLink power injector PDXL-2 (FG1090-170) and PS-POE-AT-TC (FG423-84); other power injectors may potentially damage the DXLink equipment.

IMPORTANT: If local power is used for the DXLink Modules, it must come from the provided desktop power supplies, which must not be altered in any way.

Power Budget Planning for Enova DGX 3200 with DXLink Boards

Before installing an Enova DGX 3200 Switcher and connecting any required DXLink Transmitters and Receivers, the power draw for the system should be calculated in order to maintain the power redundancy of the power supplies in the enclosure. (Each Enova DGX 3200 enclosure ships with two mutually-redundant power supplies.)

IMPORTANT: If you do not want to draw power from the Enova DGX 3200 enclosure's power supplies, you must power the DXLink Transmitter and Receiver Modules with local power (must use the provided desktop power supply) or remote power (must be a DXLink power injector). Local or remote power always overrides power from the switcher. If local or remote power is turned off, the DXLink Transmitters and Receivers do not power down but immediately start drawing power from the switcher.

Power Budget Calculation

Calculating the power budget helps determine how many DXLink Transmitters and Receivers can be powered via the Enova DGX 3200 Switcher while maintaining power redundancy if one of the power supplies should fail. The Enova DGX Configuration Tool is used to determine the switcher's power budget. Simply enter the types of boards and the number of DXLink Transmitters and Receivers to be powered via the switcher, and the calculator shows the resulting power draw. The Enova DGX Configuration Tool is located at www.amx.com/enova. If more DXLink units are required than the switcher can support while maintaining redundancy, they must be powered using the provided desktop power supplies (which must not be altered in any way) or a DXLink power injector; otherwise, damage may occur.

Foregoing Power Supply Redundancy

Depending on particular Enova DGX 3200 Switcher input and output board configurations, operating over the redundant power supply level may be necessary on a permanent basis for some installations. While foregoing the benefits associated with a redundant power supply should be understood, operating without redundancy is in no way detrimental to the system, as long as both power supplies are operational. In this case, necessary power will be pulled evenly from both supplies. However, the loss of one power supply will result in the system being non-operational from a normal "non-redundant" system capability perspective.

In the Event of a Power Supply Failure

If an Enova DGX 3200 power supply fails, check the table below to determine which situation applies and any actions that may be required:

System	Condition	Result/Required Action
Enova DGX 3200	Within power budget	The system will continue to run; okay to leave it powered until the failed power supply is replaced.
	Over power budget	The remaining power supply will turn off. If enough DXLink Transmitter or Receiver Modules are removed (or otherwise powered) to bring the system's power budget within its maximum limit, the system will be able to run until the failed power supply is replaced. (You can also remove some input and/or output boards.)

NOTE: The table above does not apply to the Enova DGX 800/1600/6400 because the system is capable of providing power for the maximum number of DXLink Transmitters and Receivers required when the enclosure contains all DXLink Twisted Pair Input and Output boards.

In both the situations in the table above, the power supply should be replaced as soon as possible to restore power redundancy to the system or to allow the system to become fully operational again. Unless the Enova DGX 3200 has exceeded its power budget, it should operate normally with a failed power supply. For power supply replacement information, contact technical support.

Connecting Switching Systems with DXLink Connectors

Switching systems with DXLink Twisted Pair support (e.g., an Enova DGX Switcher and an Enova DVX-3150HD) can be connected via their DXLink (RJ-45) ports.

IMPORTANT: This section does not refer to the linking of enclosures from CPU to CPU, which is not supported in the Enova DGX Switcher.

In an installation with a multiple-stage switching system, the following applies:

- When two switching systems with DXLink support are connected via their DXLink ports, only video and audio will be passed through the DXLink connection.
- When a DXLink input or output on one switching system determines that it is connected to a DXLink input or output on another switching system, the DXLink port will automatically disable all Ethernet, power, and control on that connection port so that the only things passed down the DXLink line are the video and audio signals.
- When connecting switching systems via DXLink ports, AMX recommends *no more than 3 switcher throughputs*. For example, the path through 3 switchers could be: source device > DVX-3250HD (out a DXLink/HDMI port) > DGX 3200, DXLink input (out a DXLink port) > DGX 1600, DXLink input (out a DXLink port) > DXLink Receiver > display device as an HDMI signal.
- Network loops *must* be avoided (see below).

Avoiding Network (Ethernet) Loops

See page 55.

Important Twisted Pair Cabling Requirements and Recommendations

The following requirements and recommendations apply to cabling DXLink (RJ-45) connectors:

- DXLink cable runs require shielded category cable (STP) of Cat6 (or better).
- DXLink twisted pair cable runs for DXLink equipment shall only be run within a common building.

NOTE: A Common building is a building in which the walls of the structure(s) are physically connected and the structure(s) share a single ground reference.

- DXLink delivers 10.2 Gb/s throughput over shielded category cable. Based on this bandwidth requirement, we recommend following industry standard practices designed for 10 Gigabit Ethernet when designing and installing the cable infrastructure.
- The cables should be no longer than necessary to reach the end-points. We recommend terminating the cable to the actual distance required rather than leaving any excess cable in a service loop.
- For complete cable specifications, see the board's specifications.

NOTE: For more details and helpful cabling information, reference the white paper titled "Cabling for Success with DXLink" available at www.amx.com or contact your AMX representative.

Twisted Pair Cable Pinouts

Use either the T568A or T568B pinout specification for termination of the twisted pair cable used between the Transmitter or Receiver and the enclosure (FIG. 44):

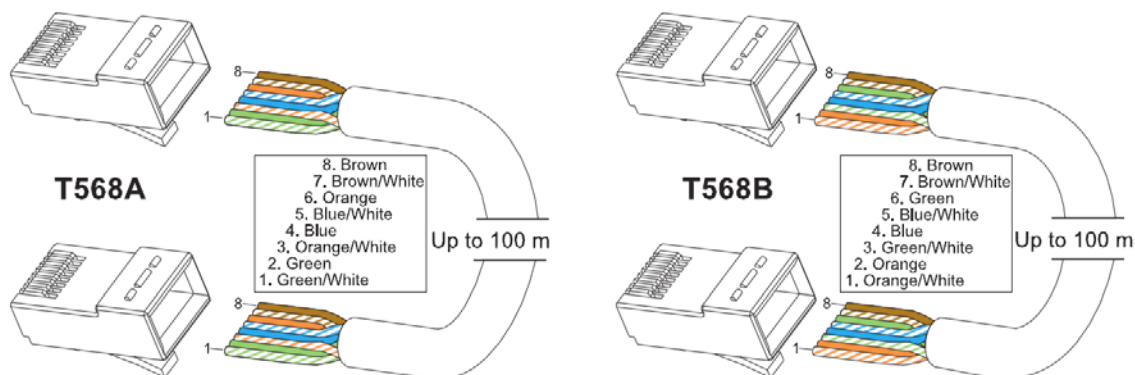

FIG. 44 Twisted pair cable pinouts for T568A and T568B

Connecting Sources and Destinations to DXLink Inputs and Outputs via TX/RX

1. Attach an HDMI cable from the source device to the HDMI connector on the DXLink Transmitter.
2. Attach a twisted pair cable to the DXLink Transmitter's Output (RJ-45) connector.
3. Attach the other end of the twisted pair cable to the input connector on the DXLink Input Board.
4. Attach a second twisted pair cable to the output connector on the DXLink Output Board.

5. Attach the other end of the second twisted pair cable to the Input (RJ-45) connector on the DXLink Receiver.
6. Attach a second HDMI cable to the HDMI Output connector on the Receiver.
7. Attach the other end of the second HDMI cable to the destination device.
8. Repeat steps above for additional source and destination devices.
9. If the enclosure is not being used as the source of power, attach the provided desktop power supplies to the transmitters and receivers.

NOTE: If the enclosure already has power applied, as soon as transmitters and receivers are connected they will have power.

10. Apply power to the source and destination devices.

NOTE: DXLink Boards can also work in conjunction with Audio Switching Boards (see page 164) and Audio Insert/Extract Boards (see page 175).

NOTE: DXLink Twisted Pair 4K cable runs include support for up to two (2) patch cables of up to 5 meters in length each, provided that the total end-to-end cable length does not exceed 80 meters and all cables and couplers/patch panels used in the run meet the minimum cable requirements (e.g., from DX-TX-DWP-4K to 5m patch cable, 70m cable run, 5m patch cable to DXLink 4K Input Board using shielded Cat6A or better for each cable length).

DXLink Connector LEDs

FIG. 45 describes the LEDs on the DXLink connectors on the DXLink Input and Output Boards:

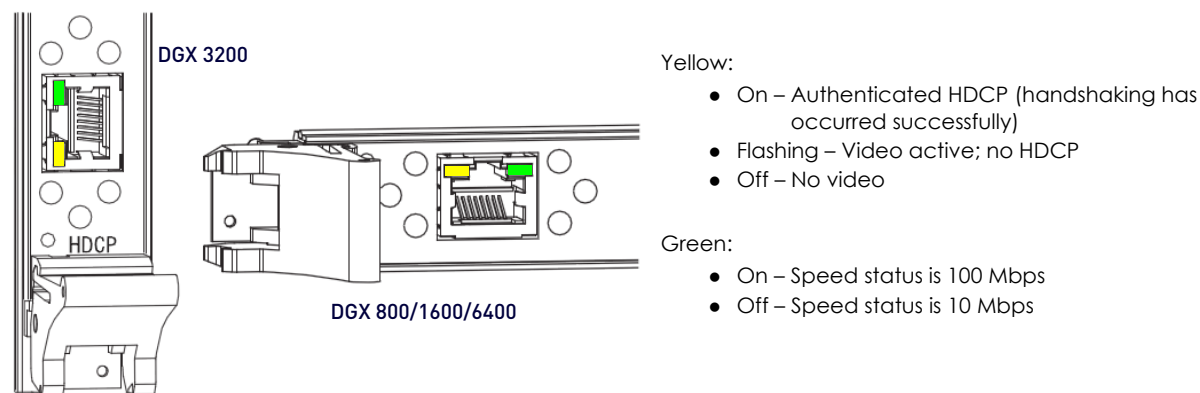

FIG. 45 DXLink connector LEDs

Configuring DXLink Endpoints for Communication with a Master

DXLink Transmitters and Receivers may be configured for communication in one of two ways: auto-setup or traditional NetLink binding. The instructions in this section cover configuration through auto-setup. For instructions that cover configuring TXs and RXs through traditional NetLink binding, see the *Hardware Reference Manual – DXLink Twisted Pair Transmitters/Receiver*.

DXLink endpoints ship from the factory with a default mode which allows auto-setup to work without additional configuration. If the endpoint has not been altered from its default settings, it should not require any of the following instructions.

NOTE: For information of control signals passed through an Enova DGX with configured DXLink Transmitter and Receiver, see the *Serial Data Transfer and IR Flow Control* section on page 122.

Best Practices for Configuration

Best practices for configuring endpoints includes using auto-setup. Auto-setup is designed to reduce the number of IP addresses consumed by a complete system. In a system that does not use auto-setup, each endpoint requires its own IP address whereas a system that uses auto-setup requires only one IP address (for the integrated Master) and each endpoint is configured for communication via a private LAN (ICS LAN) hosted by the integrated Master.

DIP Switch Toggles

The following table contains some of the most common scenarios for setting up DXLink Transmitters and Receivers with an Enova DGX Switcher (the default for all four DIP switch toggles is OFF).

IMPORTANT: Find the scenario in the table below that you want to use and set the DIP switches accordingly.

The DIP switches are on the bottom of the DXLink Modules, on the rear of the DXLink Wallplate, and on the front of the DXLink Decor Style Wallplate (hidden by front cover plate). A detailed description of functions for each toggle is provided in the *Hardware Reference Manual – DXLink Twisted Pair Transmitters/Receiver* at www.amx.com.

Common Scenarios	DIP Switch Toggle Settings			
Switcher Setup – TX/RX with Enova DGX 100 Series	1	2	3	4
AV with NetLink control of TX/RX unit and serial/IR ports	OFF	OFF	ON	OFF

Common Scenarios	DIP Switch Toggle Settings			
AV with NetLinX control of TX/RX unit and serial/IR ports, plus Ethernet passthrough to networked device. Note: Connect the ICS LAN 10/100 port of the DXLink unit to the network device (e.g., laptop, IP controlled projector, AMX ICS Lan EXB device).	ON	OFF	ON	OFF

- #1 Toggle settings do not apply to Wallplate TX & Decor Wallplate TX – leave #1 Toggle OFF.
- Each toggle's ON position is toward the connectors on the rear of the DXLink Modules or toward the top of the unit for the DXLink Wallplate TXs and Decor Wallplate TXs.

Auto-setup

To configure TXs and RXs using traditional NetLinX binding (requires disabling auto-setup), see the *Hardware Reference Manual – DXLink Twisted Pair Transmitters/Receiver*.

Need to Know for Auto-setup

- Endpoints **must be** set to DHCP Mode (default)
- Endpoints **must use** NDP Master connection mode (default)
- Endpoints **must not be** currently bound (traditional NetLinX binding) to a Master
- Endpoint DIP switch setting for Toggle #3 (network connectivity) is ignored while in auto-setup mode

Disabling Auto-setup Mode

Auto-setup can be disabled for DXLink endpoints by using the System Configuration interface (see the *System Configuration Interface* section on page 184) or via DGX_SHELL commands (see below).

IMPORTANT: The DGX_SHELL command to disable auto-setup mode does not persist over a power cycle. If your installation requires disabling auto-setup through endpoint power cycles, use the System Configuration interface for this setting.

1. Open a terminal emulation program.
2. At the prompt (DGX_SHELL>), type the command to disable auto-setup (To determine the BCPuX variable, see page 275):

Disable all ports on an input or output board –
set BCPuX_auto_setup_disabled=1,2,3,4

Disable port #2 on an input or output board –
set BCPuX_auto_setup_disabled=2

Disable all boards in the system (including DXLink Fiber) –
set BCPu_auto_setup_disabled=1,2,3,4

3. The endpoint detects the change and reboots with auto-setup disabled.
4. Use traditional NetLinX binding to configure DXLink TXs/RXs.

Enabling Auto-setup Mode

Auto-setup is enabled by default. If disabled, auto-setup can be enabled for DXLink Twisted Pair endpoints by using the System Configuration interface (see page 143) or DGX_SHELL commands (see below).

Enable Auto-setup Mode via DGX_SHELL Commands

1. Open a terminal emulation program.
2. At the prompt (DGX_SHELL>), type the command to enable auto-setup (to determine the BCPuX variable, see page 275):

Enable all ports on an input or output board –
set BCPuX_auto_setup_disabled=,,,

Enable port #2 on an input or output board –
set BCPuX_auto_setup_disabled=1,3,4

Enable all boards in the system (including DXLink Fiber) –
set BCPu_auto_setup_disabled=,,,

3. The endpoint detects the change and reboots with auto-setup enabled.

Telnet Access to Endpoints in Auto-setup Mode

Endpoints in auto-setup mode are accessible through the ICS LAN port on the Switcher's CPU. Control is established through a Telnet session with appropriate Telnet commands for the DXLink Twisted Pair module or wallplate (see the *Hardware Reference Manual – DXLink Twisted Pair Transmitters/Receiver* at www.amx.com).

CAUTION: The ICS LAN port acts as a DHCP server (private LAN) and the LAN 100/1000 port acts as a DHCP client (public LAN) with each port on a separate network. In order to avoid a Network Loop, **do not** connect any device on one network to any branch on the other network.

IMPORTANT: If auto-setup is being used, Telnet is the only way to access some of the network settings. Also note that some network settings will disable the auto-setup feature (reference the section "Need to Know for Auto-setup" on page 121).

Telnet Access to DXLink Endpoints

1. Connect a PC to the ICS LAN port on the left side of the Switcher's CPU.
2. Open NetLinX Studio.
3. In the OnLine Tree, listen for the **198.18.0.1** device (internal Master IP) and establish a connection.
4. Right-click the endpoint and select TELNET Window/Launch TELNET Window via NetLinX Studio.

NOTE: For additional information on DXLink Modules and Wallplates, see the "Hardware Reference Manual – DXLink Twisted Pair Transmitters/Receiver."

Serial Data Transfer and IR Flow Control

FIG. 46 shows the bidirectional serial data transfer and IR flow control when an Enova Digital Media Switcher is used with DXLink Modules connected to both input and output boards.

The switcher has an integrated NetLinX NX Central Control Processor which provides native AMX control at each remote location fed by a DXLink Transmitter or Receiver. Control is sent over twisted pair cable via the DXLink ports:

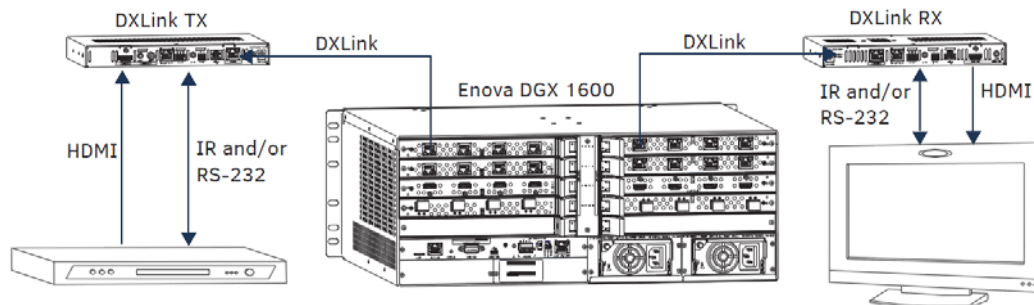

FIG. 46 Serial data transfer and IR flow control

DXLink Twisted Pair / DXLink Twisted Pair 4K Compatibility

By default, DXLink 4K Input Boards provide a 4K EDID to all connected DXLink Transmitter devices. While DXLink Transmitters are supported by the DXLink 4K Input Board, the default EDID provided to the Transmitter may result in a source device (computer, media player, etc) presenting a video resolution out of the Transmitter's range. To ensure the source device presents a resolution the DXLink Transmitter can support, simply use the Enova DGX 100 Series System Configuration interface to select a non-4K EDID (All, Wide, Full in non-4K range) to ensure a supported format is requested by the DXLink Transmitter.

Some older DXLink Twisted Pair Receivers are not compatible with DXLink Twisted Pair 4K Output Boards. Receiver and DXLink Twisted Pair 4K Output Board compatibility are established through:

- **In NetLinX Studio** – If the Receiver is referenced as "DXLINK-HDMI-RX.c" (ends in ".c"), the Receiver is incompatible. Receivers with the suffix ".e" are fully compatible with DXLink Twisted Pair 4K Output Boards.
- **On the physical endpoint** – If the Receiver has a date code of less than 26D (e.g., 1010500AP18C0034 has a date code of 18C), the Receiver is incompatible. Receivers with a date code of 26D or greater (e.g., 1010500AP27E0034) are fully compatible with DXLink Twisted Pair 4K Output Boards.

NOTE: Compatibility is available between DXLink Twisted Pair equipment and DXLink Twisted Pair 4K equipment. Refer to the "DXLink Compatibility" Appendix in the "DXLink Twisted Pair 4K Transmitters and Receivers Hardware Reference Manual" for details.

Troubleshooting Audio

Problem	Solution
<p><i>Audio not present or intermittent with good video.</i></p> <p>A signal containing both video and audio must have space for both signal portions. The audio signal portion lies in the blanked portion of the video signal. High Bit Rate Audio (HBRA) requires a larger than normal space in the blanked area of the signal. Video formats with reduced blanking normally provide enough space for audio signals. In a signal that combines a video format with reduced blanking and HBRA, the HBRA signal is truncated and can present as either no audio or as problematic audio (static, clicking, absent, etc.). While Enova DGX hardware supports both HBRA and reduced blanking video formats, these formats do not necessarily work with one another.</p>	<p>Change either the audio format to non-HBRA or change the video format to a format that does not use reduced blanking.</p>

DXLink Twisted Pair 4K Input and Output Boards

Overview

This chapter pertains to Enova DGX DXLink™ Twisted Pair 4K Input and Output Boards:

- FG1061-570 Input board
- FG1061-580 Output board

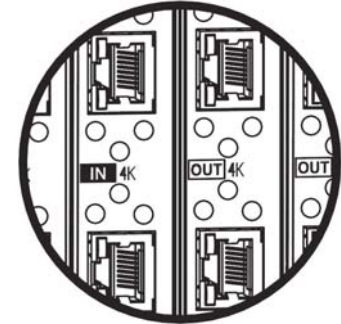
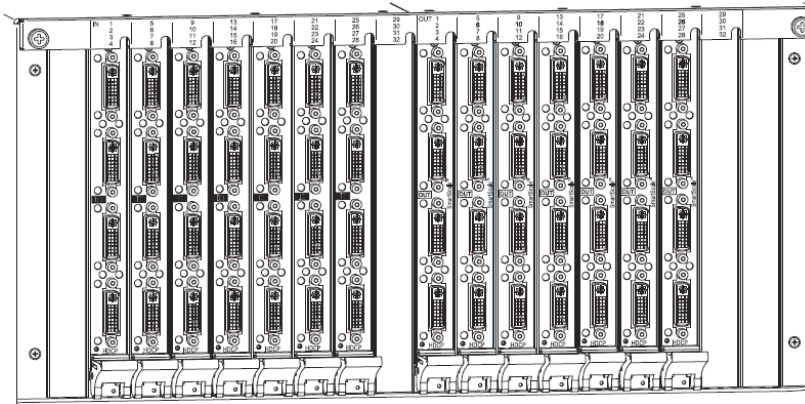

Enova DGX DXLink Twisted Pair 4K Boards feature a 4K label beside the IN or OUT label.

FIG. 47 DXLink Twisted Pair 4K Input and Output Boards

Enova DGX Enclosure Support for DXLink Twisted Pair 4K Input and Output Boards	
DGX 800	Enova DGX 800 enclosures can hold up to four DXLink Twisted Pair 4K Boards with four RJ-45 inputs or outputs per board. Each enclosure holds a maximum of two input and two output boards, accommodating connector configurations up to a maximum of 8x8, as well as three subsets (i.e., 4x4, 4x8, or 8x4).
DGX 1600	Enova DGX 1600 enclosures can hold up to eight DXLink Twisted Pair 4K Boards with four RJ-45 inputs or outputs per board. Each enclosure holds a maximum of four input and four output boards, accommodating connector configurations up to a maximum of 16x16, as well as subsets (e.g., 16x8 or 4x12).
DGX 3200	Enova DGX 3200 enclosures can hold up to sixteen DXLink Twisted Pair 4K Boards with four RJ-45 inputs or outputs per board. Each enclosure holds a maximum of eight input and eight output boards, accommodating connector configurations up to a maximum of 32x32, as well as subsets (e.g., 12x24 or 32x8).
DGX 6400	Enova DGX 6400 enclosures can hold up to thirty-two DXLink Twisted Pair 4K Boards with four RJ-45 inputs or outputs per board. Each enclosure holds a maximum of sixteen input and sixteen output boards, accommodating connector configurations up to a maximum of 64x64, as well as subsets (e.g., 12x48 or 52x8).

NOTE: For full capability, DXLink Twisted Pair 4K Boards must be used in conjunction with DXLink Twisted Pair 4K Transmitters and Receivers. Additional compatibility is available between DXLink Twisted Pair 4K equipment and DXLink Twisted Pair equipment (see the "DXLink Compatibility" Appendix in the "DXLink Twisted Pair 4K Transmitters and Receivers Hardware Reference Manual" at www.amx.com).

By default, DXLink 4K Input Boards provide a 4K EDID to all connected DXLink Transmitter devices. While DXLink Transmitters are supported by the DXLink 4K Input Board, the default EDID provided to the Transmitter may result in a source device (computer, media player, etc) presenting a video resolution out of the Transmitter's range.

To ensure the source device presents a resolution the DXLink Transmitter can support, simply use the Enova DGX 100 Series System Configuration interface to select a non-4K EDID (All, Wide, Full in non-4K range) to ensure a supported format is requested by the DXLink Transmitter. For information about compatibility between DXLink Twisted Pair 4K and endpoints, see the *DXLink Twisted Pair 4K Transmitters and Receivers Hardware Reference Manual* at www.amx.com.

Signal Routing

DXLink Twisted Pair 4K Input Boards route signals to DXLink Twisted Pair 4K Output Boards or to any other type of Enova DGX Output Boards. DXLink Twisted Pair 4K Output Boards can also accept signals from all of the other types of Enova DGX Boards. When routing signals between different board types, the Enova DGX Switcher automatically converts the signal format to match the output board.

Signals that can be sent over DXLink Twisted Pair 4K Boards include: HDMI, DVI-D, analog video, analog audio, digital audio, and embedded audio. DXLink Twisted Pair 4K Boards also work in conjunction with Audio Switching Boards (see page 171) or Audio Insert/Extract Boards (see page 183).

IMPORTANT: Because the DXLink, DVI, and HDMI Boards in the Enova DGX Switcher normally produce a quality image, you will not need to make adjustments or custom scaler settings unless the installation has special scaling, EDID, or HDCP requirements (if adjustments are necessary, use the System Configuration interface; see page 127).

NOTE: Enova DGX DXLink Twisted Pair 4K Boards do not support CEC.

HDCP Compliance

If a connected downstream sink is not HDCP compliant, then the Output Board *will not* send the signal to it. This does not affect other outputs the source may be routed to. This allows compliant displays to show content from source devices even if the source devices are switched to non-compliant displays. Non-compliant displays can easily be identified because they display a dark red image (via an HDMI/DVI Output) or an orange image (via a DXLink RX) to indicate that the authentication process failed.

InstaGate Pro Technology

- DXLink Twisted Pair 4K Boards meet HDCP standards and support InstaGate Pro Technology. For information on HDCP functionality for DXLink boards, see "HDCP Support on Enova DGX Switchers" on page 98.
- DXLink Twisted Pair 4K Boards provide EDID emulation support with plug-and-play information provided by the Enova DGX Switcher.
- DXLink Twisted Pair 4K input and output connectors incorporate HDMI Technology, are HDCP 1.4 compatible, and feature InstaGate Pro Technology* for low-latency switching of HDCP protected content. The DXLink Twisted Pair 4K connectors also support embedded audio, both linear PCM (stereo audio) and non-linear PCM (Dolby Digital, Dolby TrueHD, DTS, etc).

DXLink Twisted Pair 4K Boards Specifications

Applies to input board FG1061-570 (DGX-I-DXL-4K) and output board FG1061-580 (DGX-O-DXL-4K). This section applies to products with full compatibility (including a complete 4K signal path). For compatibility between DXLink Twisted Pair 4K products and DXLink Twisted Pair products, see the *DXLink Twisted Pair 4K Transmitters and Receivers Hardware Reference Manual*.

Compatible AMX DXLink- Twisted Pair 4K Transmitters and Receivers:

- DXLink 4K HDMI Decor Style Wallplate TX: FG1010-330-BL and FG1010-330-WH (DX-TX-DWP-4K)
- DXLink 4K HDMI RX: FG1010-510 (DX-RX-4K)

Compatible AMX Solecis 4K Digital Switchers (1 Output per Switcher):

- Solecis 4x1 4K HDMI Digital Switcher with DXLink Output: FG1010-314 (SDX-414-DX)
- Solecis 5x1 4K Multi-Format Digital Switcher with DXLink Output: FG1010-355 (SDX-514M-DX)

IMPORTANT: *DXLink twisted pair cable runs for DXLink equipment shall only be run within a common building. "Common building" is defined as: Where the walls of the structure(s) are physically connected and the structure(s) share a single ground reference.*

DXLink Twisted Pair 4K Input and Output Boards - Specifications	
Compatible AMX DXLink™ Twisted Pair 4K Products	4K HDMI Decor Style Wallplate TX, 4K HDMI RX, other AMX DXLink signal management products Note: For additional compatibility with DXLink Twisted Pair products, see the "DXLink Twisted Pair 4K Transmitters and Receivers Hardware Reference Manual" at www.amx.com .
Compatible Formats	HDMI Video, Audio, Ethernet, USB (HID), Power, and Control
Signal Type Support	DXLink Twisted Pair
Transport Layer Throughput (max.)	10.2 Gbps
Video Data Rate (max.)	8.91 Gbps (max)
Video Pixel Clock (max.)	297 MHz
Progressive Resolution Support	480p up to 4096x2160p,60 Hz (Y/Cb/Cr 4:2:0 and 4K RX Scaler in Bypass) Note: See full list of supported formats on page 125.
Interlaced Resolution Support	480i, 576i, 1080i If input is interlaced, all scaled outputs will de-interlace video to a progressive resolution format. If in scaler Bypass mode, interlaced input will pass through unaltered.
Deep Color Support	Up to 1080p: 24-bit, 30-bit, 36-bit 30-bit, 36-bit only supported when the HDMI Output Board Scaler or DXLink RX Scaler is in Bypass mode and format is 1080p60 or less.
Color Space Support	<ul style="list-style-type: none"> • RGB 4:4:4 • YCbCr 4:4:4, 4:2:2, and 4:2:0 Input signal for YCbCr 4:4:4 and 4:2:2, output color-space is converted to RGB 4:4:4. 4:2:0 only supported at 2160p 50/60Hz with 4K RX Scaler in Bypass.
3D Format Support	HDMI primary formats, when used with DXLink Output Boards and the RX Scaler is in Bypass mode <ul style="list-style-type: none"> • Frame Packing 1080p up to 24 Hz • Frame Packing 720p up to 50/60 Hz • Frame Packing 1080i up to 50/60 Hz • Top-Bottom 1080p up to 24 Hz • Top-Bottom 720p up to 50/60 Hz • Side-by-Side Half 1080i up to 50/60 Hz

DXLink Twisted Pair 4K Input and Output Boards - Specifications (Cont.)	
4K Resolution Support	<ul style="list-style-type: none"> 3840x2160p@24/25/30 Hz 4096x2160p@24/25/30 Hz 3840x2160p@60 Hz, 4:2:0* 4096x2160p@60 Hz, 4:2:0* <p>* Supported by DX-RX-4K when in Bypass Scaling mode. Note: See full list of supported formats on page 125.</p>
Audio Format Support	<ul style="list-style-type: none"> Dolby TrueHD, Dolby Digital, DTS-HD Master Audio, DTS, 2 CH through 8 CH L-PCM (Dolby Digital and DTS support up to 48 kHz, 5.1 channels)
Audio Resolution	16 bit to 24 bit
Audio Sample Rate	32 kHz, 44.1 kHz, 48 kHz, 96 kHz, 192 kHz
Local Audio Support	Insertion and/or extraction of 2 CH L-PCM selectable by channel
Audio Switching Board Support	<ul style="list-style-type: none"> Supports break-away audio switching of 2 CH L-PCM for all channels Supports down-mix from one input channel of Dolby True-HD, Dolby Digital, DTS-HD, DTS, or 2 to 8 channel L-PCM
EDID Support	<ul style="list-style-type: none"> EDID provided by Enova DGX Digital Media Switcher to the digital (HDMI) input on the DXLink Transmitter EDID is user re-programmable
HDCP Support	<p>Full matrix HDCP 1.4 support (includes any input to any or all outputs)</p> <ul style="list-style-type: none"> key Management System AMX HDCP InstaGate Pro® Technology key support up to 16 destinations per output, independent of source device
CEC Support	None
ICSP, TCP/IP, USB, IR, Serial, and Control Management	Control Distribution is managed by the Enova DGX on-board NetLinx NX Master and Ethernet Switch
USB (HID) Transport	<p>Use the Enova DGX Digital Media Switcher in conjunction with DXLink Transmitters and Receivers (twisted pair and/or fiber), connect a DXLink Transmitter with HID hardware support to a PC and a DXLink Receiver to a keyboard and mouse, the system then emulates commands from the receiver back to the PC.</p> <p>A list is available of HID devices which have been tested and found to work well with the latest firmware (see "DXLink - HID Supported Devices" on the RX's product page at www.amx.com).</p>
DXLink Twisted Pair Power	DXLink Twisted Pair 4K Transmitters and Receivers can have power supplied over twisted pair cable when connected to a DXLink Input or Output Board on the Enova DGX Digital Media Switcher
Input Board Propagation Delay	5 μs
Output Board Propagation Delay	5 μs
Connectors	4 RJ-45 ports
Twisted Pair Cable Type	<ul style="list-style-type: none"> Shielded Cat6A and Cat7 <p>Note: For details and helpful cabling information, reference the white paper titled "Cabling for Success with DXLink" available at www.amx.com or contact your AMX representative.</p>
Twisted Pair Cable Length	<p>Up to 262 ft. (80 m) for full 4K signal support. Up to 328 ft. (100 m) for 1080p and below.</p>
HDMI Cable Requirement	HDMI High-Speed Cable Category 2 Required
Important Notice	DXLink twisted pair cable runs for DXLink equipment shall only be run within a common building. A "Common building" is defined as: Where the walls of the structure(s) are physically connected and the structure(s) share a single ground reference.

EDID Resolutions Supported through Local DDC

This section covers all of the default EDIDs. In the System Configuration interface, the EDIDs contained in this section's tables are displayed in a single dropdown menu (General section, Preferred EDID menu) and VICs are differentiated by the presence of a "p" or "i" in the format. Standard and established timings are given in the tables following along with detailed timing blocks.

IMPORTANT: The EDID can be configured to support additional resolutions through the local DDC using the EDID options in the System Configuration interface (see page 140).

NOTE: The Consumer Technology Association (CTA) was formerly known as the Consumer Electronics Association (CEA): the CEA 861 video standard has been renamed to CTA 861.

DTD (Detailed Timing Descriptor)

Resolution	Refresh Rate Max	Video Standard	
3840x2160p	30 Hz	CTA (VIC 95)	Preferred timing (identified in the EDID)
1920x1080p	60 Hz	CTA (VIC 16)	
1920x1080p	50 Hz	CTA (VIC 31)	
1920x1200	50 Hz	CVR	
1920x1200	60 Hz	CVR	

Standard Timings

Resolution	Refresh Rate Max.
1920x1200	60 Hz
1680x1050	60 Hz
1600x1200	60 Hz
1440x900	60 Hz
1360x765	60 Hz
1280x1024	60 Hz
1280x800	60 Hz
1280x720	60 Hz

Established Timings

Resolution	Refresh Rate Max.
1280x1024	75 Hz
1152x870	75 Hz
1024x768	60 Hz, 70 Hz, 75 Hz, 87 Hz
832x624	75 Hz
800x600	56 Hz, 60 Hz, 72 Hz, 75 Hz
720x400	70 Hz, 88 Hz
640x480	60 Hz, 67 Hz, 72 Hz, 75 Hz

NOTE: Audio problems may result from passing Dolby or DTS or high PCM frequency rates to a destination device that does not support them. Video problems may result from passing a video format that the destination device does not support. In either of these cases, re-programming the EDID may help resolve the problem.

CTA Video Information Code (VIC) Formats

NOTE: The Short Video Descriptor (SVD) column describes the order of video preference.

SVD #	VIC #	Resolution	Refresh Rate and Aspect Ratio	Notes
001	VIC = 95	3840x2160p	29.97/30 Hz 16:9	HDMI VIC = 1
002	VIC = 94	3840x2160p	25 Hz 16:9	HDMI VIC = 2
003	VIC = 93	3840x2160p	23.98/24 Hz 16:9	HDMI VIC = 3
004	VIC = 100	4096x2160p	30 Hz 256:135	
005	VIC = 98	4096x2160p	24 Hz 256:135	HDMI VIC = 4
006	VIC = 99	4096x2160p	25 Hz 256:135	
007	VIC = 105	3840x2160p	30 Hz 64:27	
008	VIC = 103	3840x2160p	24 Hz 64:27	
009	VIC = 104	3840x2160p	25 Hz 64:27	
010	VIC = 16	1920x1080p	59.94/60 Hz 16:9	
011	VIC = 32	1920x1080p	23.97/24 Hz 16:9	
012	VIC = 34	1920x1080p	29.97/30 Hz 16:9	
013	VIC = 31	1920x1080p	50 Hz 16:9	
014	VIC = 33	1920x1080p	25 Hz 16:9	
015	VIC = 5	1920x1080i	59.94/60 Hz 16:9	
016	VIC = 20	1920x1080i	50 Hz 16:9	
017	VIC = 4	1280x720p	59.94/60 Hz 16:9	
018	VIC = 3	720x480p	59.94/60 Hz 16:9	
019	VIC = 19	1280x720p	50 Hz 16:9	
020	VIC = 2	720x480p	59.94/60 Hz 4:3	
021	VIC = 17	720x576p	50 Hz 4:3	
022	VIC = 6	720(1440)x480i	59.94/60 Hz 4:3	
023	VIC = 7	720(1440)x480i	59.94/60 Hz 16:9	
024	VIC = 18	720x576p	50 Hz 16:9	
025	VIC = 21	720(1440)x576i	50 Hz 4:3	
026	VIC = 22	720(1440)x576i	50 Hz 16:9	
027	VIC = 39	1920x1080i	50 Hz 16:9	
028	VIC = 90	2560x1080p	60 Hz 64:27	
029	VIC = 89	2560x1080p	50 Hz 64:27	
030	VIC = 1	640x480p	59.94/60 Hz 4:3	

Audio Data Block

Channels	Sampling Frequency
Basic Audio: 2 channel L-PCM 32, 44.1, 48 kHz	Sampling frequency at 16, 20, or 24 bits per sample

IMPORTANT: For information on troubleshooting audio, including a table on "Audio Format Support on Enova DGX Boards," see page 101.

System Setup with DXLink Twisted Pair 4K Transmitters and Receivers

DXLink Twisted Pair 4K Input and Output Boards must be used in conjunction with AMX DXLink Twisted Pair 4K Transmitters and Receivers or other AMX DXLink 4K signal management solutions. This combination creates an end-to-end extender solution for transmission of HDMI (or DVI via adapter cable) over twisted pair cable.

- Compatible DXLink Transmitters and Receivers are listed on page 124.
- System setup options are listed in the table below.
- For TX and RX installation details, see the Transmitter and Receiver's *Quick Start Guide* or *Hardware Reference Manual*.

When compatible Transmitters and Receivers are installed in conjunction with DXLink Twisted Pair 4K Boards, image adjustment and EDID scaling is automatically applied. For almost every installation, the automatic features on Transmitters and Receivers result in a quality image on the monitor.

If the installation has special requirements and needs additional adjustment, see page 127. If you need additional information on the Transmitters and Receivers or their specifications, refer to the *Hardware Reference Manual – DXLink Twisted Pair 4K Transmitters and Receivers* at www.amx.com.

The distance from a Transmitter to a Input Board can be up to 262 feet (80 m) and another 262 feet (80 m) from the Output Board to the Receiver.

IMPORTANT: *Twisted pair cable runs for Input and Output Boards shall only be run within a common building. "Common building" is defined as: Where the walls of the structure(s) are physically connected and the structure(s) share a single ground reference.*

NOTE: *Along with the video signal, the DXLink Twisted Pair 4K Boards support embedded digital audio from the Transmitters.*

Options for DXLink System Setup

The following table contains several options in an Enova DGX Switcher for using DXLink Twisted Pair 4K Input and/or Output Boards in conjunction with DXLink Twisted pair 4K Transmitters and Receivers.

NOTE: *Transmitters and Receivers can be also be used together as a standalone solution without a switcher (Wallplate Transmitters connected directly to Receivers must use DXLink power injectors); see the Hardware Reference Manual – DXLink Twisted Pair 4K Transmitters and Receivers.*

System Setup Options - Enova DGX Boards with DXLink Twisted Pair 4K Modules/Wallplates			
DXLink Module/Wallplate	Enova DGX Input Board	Enova DGX Output Board	DXLink Module
4K HDMI Decor Wallplate TX →	DXLink Twisted Pair 4K →	DXLink Twisted Pair 4K →	4K HDMI RX Module
4K HDMI Decor Wallplate TX →	DXLink Twisted Pair 4K →	Any output board* →	Not applicable*
Not applicable*	Any input board* →	DXLink Twisted Pair 4K →	4K HDMI RX Module

* If the board is a DXLink Fiber Board or DXLink Twisted Pair Board, it will need the appropriate Transmitter or Receiver; see the table on page 45.

NOTE: *Solecis 4K Digital Switchers (SDX-414-DX and SDX-514M-DX) have a DXLink Twisted Pair 4K output port that optionally provides source point switching and distance transmission to an Enova DGX DXLink Twisted Pair 4K Input Board for hub-style or campus-wide distribution.*

Example of Typical Setup with DXLink Twisted Pair 4K Transmitter and Receiver

A typical system setup for a source and a destination is illustrated below and shows an Enova DGX 1600 with DXLink Twisted Pair 4K Input and Output Boards used in conjunction with compatible Transmitters and Receivers for transport of HDMI signals.

NOTE: *This type of setup also supports DVI-D signals with the use of a cable adapter.*

The Transmitter receives an HDMI signal and an embedded digital audio signal from a source device. Both the video and embedded audio are transmitted over twisted pair cable to the RJ-45 connector on the DXLink Twisted Pair 4K Input Board.

The signal is routed through the desired DXLink Twisted Pair 4K Output connector to the Receiver, which in turn sends the HDMI signal with embedded audio on to a destination device. Audio received on the Transmitter can be output on the Receiver's stereo audio port (FIG. 48):

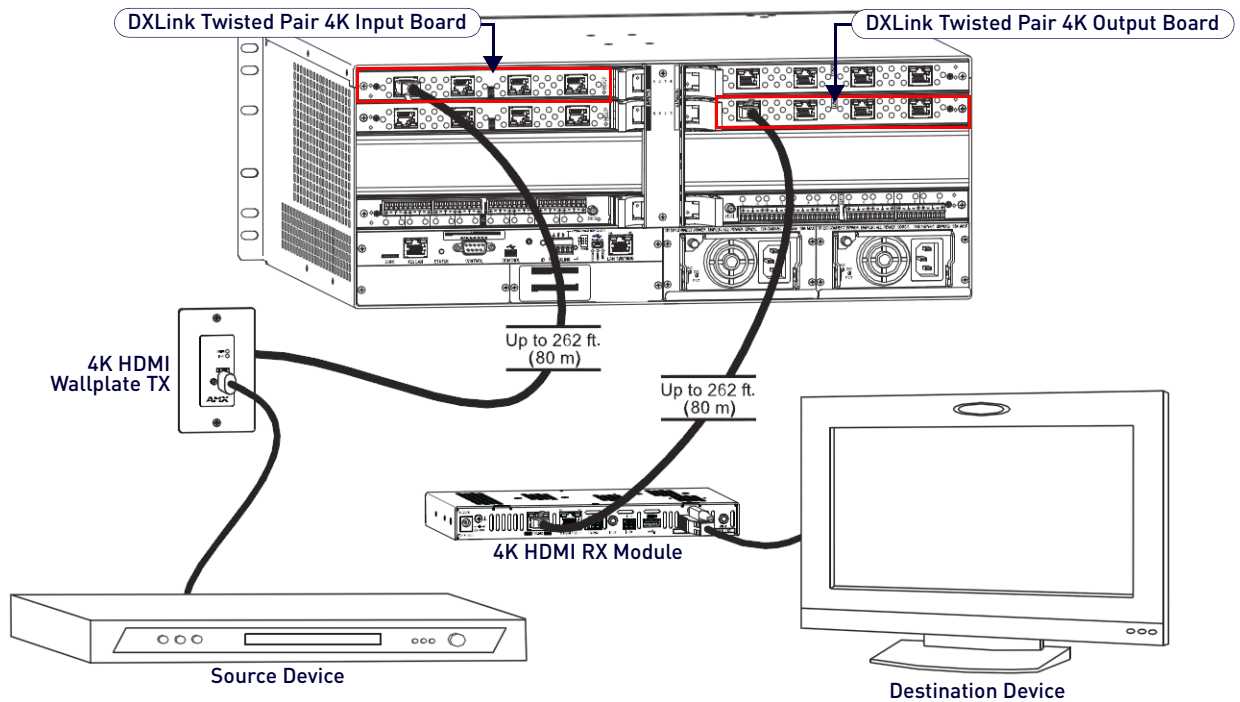

FIG. 48 DXLink Twisted Pair 4K Boards used in conjunction with DXLink TX and RX

NOTE: For systems with special requirements – Before installing in the final location, place the equipment close together, so a PC for control and the destination monitor can be seen simultaneously if adjustments are necessary. Adjustments can be made using the System Configuration interface (see page 184).

Functions of DXLink Transmitters and Receivers

The diagram in FIG. 49 shows the functions of DXLink Transmitters and Receivers and the example descriptions contain the device HDCP key count when used in conjunction with DXLink Boards in an Enova DGX Digital Media Switcher:

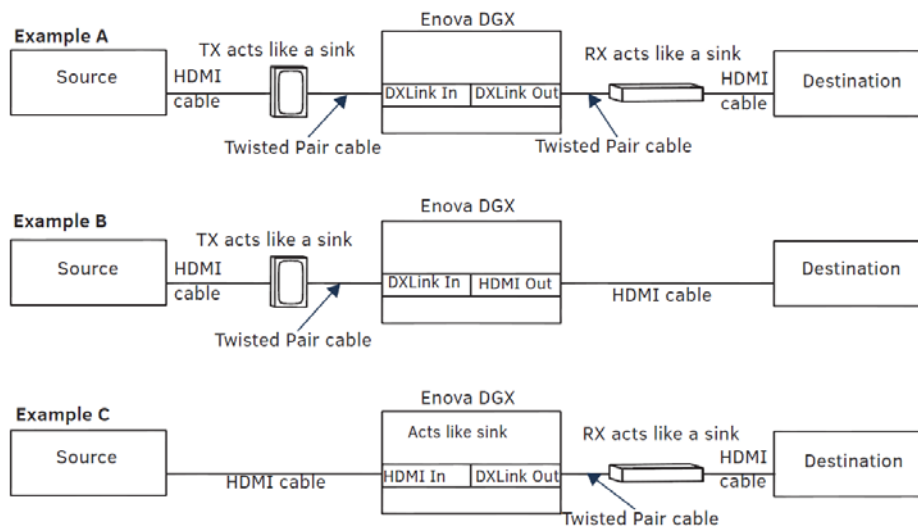

FIG. 49 DXLink Twisted Pair 4K Boards used in conjunction with DXLink TX and RX

Important Power Considerations for Enova DGX 3200 Endpoint Systems

NOTE: This section *does not* apply to the Enova DGX 800/1600/6400 because the system is capable of providing power for the maximum number of DXLink Transmitters and Receivers required when the enclosure contains all DXLink Twisted Pair 4K Input and Output boards.

In an endpoint system, the Enova DGX Switcher has DXLink Transmitters and/or Receivers attached. The Transmitters and Receivers can be powered either locally, remotely, or via the switcher (the last two ways are considered DXLink power since power is received via the DXLink line).

- **Local power** – Local power on a DXLink Transmitter or Receiver always takes precedence over power via the DXLink line from the switcher. However, if a locally powered Module is connected to a switcher and the local power is lost (i.e., unplugged or turned off), the Module will power down and then automatically power back up using power from the switcher via the DXLink connection (increasing the overall power draw on the switcher). When local power is restored, it automatically replaces the power over the DXLink line.
- **DXLink power** – When DXLink Transmitters or Receivers are being powered by an Enova DGX DXLink board or DXLink power injector (using power via the DXLink line), to maintain the switcher's power redundancy, we recommend that you:

Determine the power budget based on the input/output boards used and the quantity of powered endpoints (DXLink Modules and Wallplates); see the following page.

Do not use the local DC power jack on the Module (even if the local power adapter is off).

NOTE: AMX supports the use of DXLink power injector PDXL-2 (FG1090-170) and PS-POE-AT-TC (FG423-84); other power injectors may potentially damage the DXLink equipment.

IMPORTANT: If local power is used for the DXLink Modules, it must come from the provided desktop power supplies, which must not be altered in any way.

Power Budget Planning for Enova DGX 3200 with DXLink Boards

Before installing an Enova DGX 3200 Switcher and connecting any required DXLink Transmitters and Receivers, the power draw for the system should be calculated in order to maintain the power redundancy of the power supplies in the enclosure. (Each Enova DGX 3200 enclosure ships with two mutually-redundant power supplies.)

IMPORTANT: If you do not want to draw power from the Enova DGX 3200 enclosure's power supplies, you must power the DXLink Receiver Modules with local power (must use the provided desktop power supply) or remote power (must be a DXLink power injector). Local or remote power always overrides power from the switcher. If local or remote power is turned off, DXLink Receiver Modules do not power down but immediately start drawing power from the switcher.

Power Budget Calculation

Calculating the power budget helps determine how many DXLink Transmitters and Receivers can be powered via the Enova DGX 3200 Switcher while maintaining power redundancy if one of the power supplies should fail. The Enova DGX Configuration Tool is used to determine the switcher's power budget. Simply enter the types of boards and the number of DXLink Transmitters and Receivers to be powered via the switcher, and the calculator shows the resulting power draw. The Enova DGX Configuration Tool is located at www.amx.com/enova. If more DXLink units are required than the switcher can support while maintaining redundancy, they must be powered using the provided desktop power supplies (which must not be altered in any way) or a DXLink power injector; otherwise, damage may occur.

Foregoing Power Supply Redundancy

Depending on particular Enova DGX 3200 Switcher input and output board configurations, operating over the redundant power supply level may be necessary on a permanent basis for some installations. While foregoing the benefits associated with a redundant power supply should be understood, operating without redundancy is in no way detrimental to the system, as long as both power supplies are operational. In this case, necessary power will be pulled evenly from both supplies. However, the loss of one power supply will result in the system being non-operational from a normal "non-redundant" system capability perspective.

In the Event of a Power Supply Failure

If an Enova DGX 3200 power supply fails, check the table below to determine which situation applies and any actions that may be required:

System	Condition	Result/Required Action
Enova DGX 3200	Within power budget	The system continues to run; okay to leave it powered until the failed power supply is replaced.
	Over power budget	The remaining power supply will turn off. If enough DXLink Transmitter or Receiver Modules are removed (or otherwise powered) to bring the system's power budget within its maximum limit, the system will be able to run until the failed power supply is replaced. (You can also remove some input and/or output boards.)

NOTE: The table above does not apply to the Enova DGX 800/1600/6400 because the system is capable of providing power for the maximum number of DXLink Transmitters and Receivers required when the enclosure contains all DXLink Twisted Pair 4K Input and Output boards.

In both the situations in the table above, the power supply should be replaced as soon as possible to restore power redundancy to the system or to allow the system to become fully operational again. Unless the Enova DGX 3200 has exceeded its power budget, it should operate normally with a failed power supply. For power supply replacement information, contact technical support.

Connecting Switching Systems with DXLink Connectors

Switching systems with DXLink Twisted Pair 4K support (e.g., an Enova DGX 800 Switcher and an Enova DGX 6400 switcher) can be connected via their DXLink (RJ-45) ports.

IMPORTANT: This section does not refer to the linking of enclosures from CPU to CPU, which is not supported in the Enova DGX Switcher.

In an installation with a multiple-stage switching system, the following applies:

- When two switching systems with DXLink support are connected via their DXLink ports, only video and audio will be passed through the DXLink connection.
- When a DXLink input or output on one switching system determines that it is connected to a DXLink input or output on another switching system, the DXLink port will automatically disable all Ethernet, power, and control on that connection port so that the only things passed down the DXLink line are the video and audio signals.
- When connecting switching systems via DXLink ports, AMX recommends *no more than 3 switcher throughputs*. For example, the path through 3 switchers could be: source device > DXLink Transmitter > Enova DGX 800 (out a DXLink port) > Enova DGX 6400, DXLink input (out a DXLink port) > Enova DGX 1600, DXLink input (out a DXLink port) > DXLink Receiver > display device as an HDMI signal.
- Network loops *must* be avoided (see the following page).

Avoiding Network (Ethernet) Loops

See the *Avoiding Network (Ethernet) Loops* section on page 55.

Important DXLink Twisted Pair 4K Cabling Requirements and Recommendations

The following requirements and recommendations apply to cabling DXLink (RJ-45) connectors:

- DXLink cable runs require shielded category cable (STP) of Cat6A or Cat7.
- DXLink cable runs for DXLink equipment shall only be run within a common building.

NOTE: A Common building is a building in which the walls of the structure(s) are physically connected and the structure(s) share a single ground reference.

- DXLink delivers 10.2 Gb/s throughput over shielded category cable. Based on this bandwidth requirement, we recommend following industry standard practices designed for 10 Gigabit Ethernet when designing and installing the cable infrastructure.
- The cables should be no longer than necessary to reach the end-points. We recommend terminating the cable to the actual distance required rather than leaving any excess cable in a service loop.
- For complete cable specifications, see the board's specifications.

For more details and helpful cabling information, reference the white paper titled "Cabling for Success with DXLink" available at www.amx.com or contact your AMX representative.

NOTE: DXLink Twisted Pair 4K cable runs include support for up to two (2) patch cables of up to 5 meters in length each, provided that the total end-to-end cable length does not exceed 80 meters and all cables and couplers/patch panels used in the run meet the minimum cable requirements (e.g., from DX-TX-DWP-4K to 5m patch cable, 70m cable run, 5m patch cable to DXLink 4K Input Board using shielded Cat6A or better for each cable length).

Twisted Pair Cable Pinouts

Use either the T568A or T568B pinout specification for termination of the twisted pair cable used between the Transmitter or Receiver and the enclosure (FIG. 50):

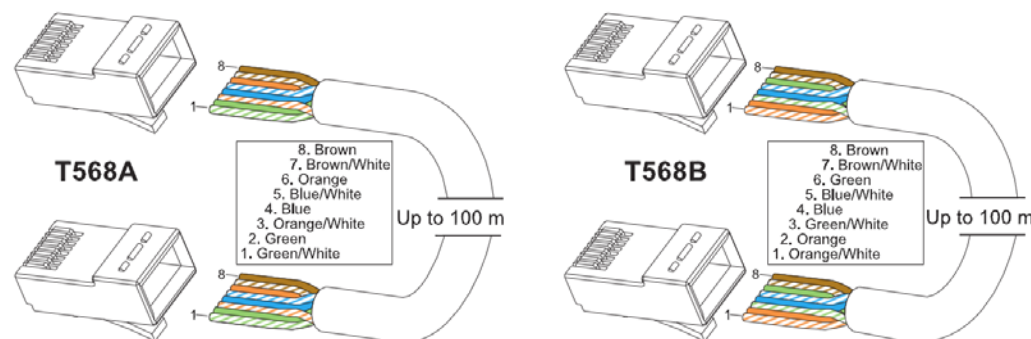

FIG. 50 Twisted pair cable pinouts for T568A and T568B

Connecting Sources and Destinations to DXLink Inputs and Outputs via TX/RX

1. Attach an HDMI cable from the source device to the HDMI connector on the DXLink Transmitter.
2. Attach a twisted pair cable to the DXLink Transmitter's Output (RJ-45) connector.
3. Attach the other end of the twisted pair cable to the input connector on the DXLink Input Board.
4. Attach a second twisted pair cable to the output connector on the DXLink Output Board.
5. Attach the other end of the second twisted pair cable to the Input (RJ-45) connector on the DXLink Receiver.
6. Attach a second HDMI cable to the HDMI Output connector on the Receiver.
7. Attach the other end of the second HDMI cable to the destination device.
8. Repeat steps above for additional source and destination devices.
9. If the enclosure is not being used as the source of power, attach the provided desktop power supplies to the receivers.

NOTE: If the enclosure already has power applied, as soon as transmitters and receivers are connected they will have power.

10. Apply power to the source and destination devices.

NOTE: DXLink Boards can also work in conjunction with Audio Switching Boards (see page 171) and Audio Insert/Extract Boards (see page 183).

DXLink Connector LEDs

The following information applies to the LEDs on the DXLink connectors on the DXLink Twisted Pair 4K Input and Output Boards (FIG. 51).

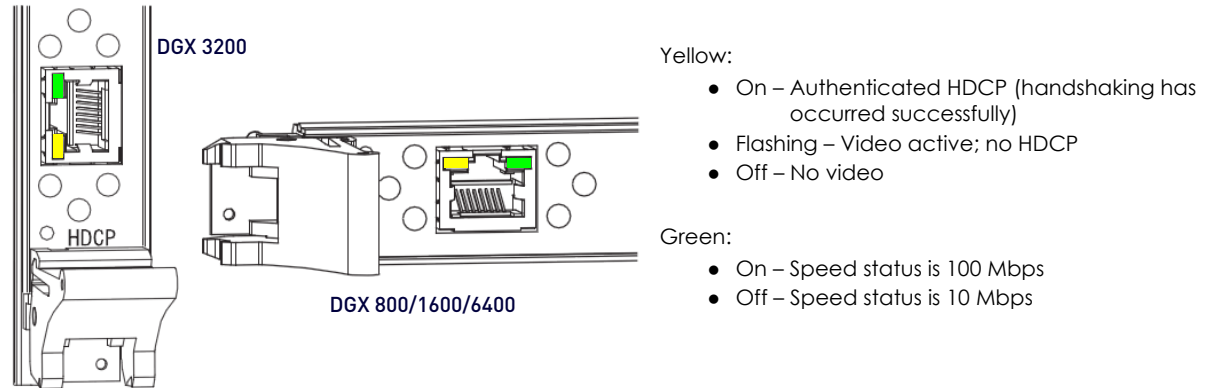

FIG. 51 DXLink connector LEDs

Configuring DXLink Endpoints for Communication with a Master

NOTE: The 4K HDMI Wallplate TX does not require configuration, regardless of the configuration of any connected Receiver units.

DXLink Twisted Pair 4K Receivers may be configured for communication in one of two ways: auto-setup or traditional NetLinx binding. The instructions in this section cover configuration through auto-setup. For instructions that cover configuring RXs through traditional NetLinx binding, see the *Hardware Reference Manual – DXLink Twisted Pair 4K Transmitters and Receivers*.

DXLink Receivers ship from the factory with a default mode which allows auto-setup to work without additional configuration. If the Receiver has not been altered from its default settings, it should not require any of the following instructions. For information covering control signals passed through an Enova DGX with configured DXLink Receivers, be sure to review "Serial Data Transfer and IR Flow Control" on page 123.

Best Practices for Configuration

Best practices for configuring Receivers includes using auto-setup. Auto-setup is designed to reduce the number of IP addresses consumed by a complete system. In a system that does not use auto-setup, each endpoint requires its own IP address whereas a system that uses auto-setup requires only one IP address (for the integrated Master) and each endpoint is configured for communication via a private LAN (ICS LAN) hosted by the integrated Master.

NOTE: 4K HDMI Wallplate TXs do not consume IP addresses.

DIP Switch Toggles

NOTE: 4K HDMI Wallplate TXs do not have DIP switch toggles and are not affected by DIP switch settings of connected RXs.

The following table contains some of the most common scenarios for setting up DXLink Receivers with an Enova DGX Switcher (the default for all four DIP switch toggles is OFF).

IMPORTANT: Find the scenario in the table below that you want to use and set the DIP switches accordingly.

The DIP switches are on the bottom of the DXLink Modules. A detailed description of functions for each toggle is provided in the *Hardware Reference Manual – DXLink Twisted Pair 4K Transmitters and Receivers* at www.amx.com.

Common Scenarios	DIP Switch Toggle Settings			
Switcher Setup – DXLink Modules with Enova DGX 100 Series	1	2	3	4
AV with NetLinx control of RX unit and serial/IR ports	OFF	OFF	ON	OFF
AV with NetLinx control of RX unit and serial/IR ports, plus Ethernet passthrough to networked device. Note: Connect the ICS LAN 10/100 port of the DXLink Module to the network device (e.g., laptop, IP controlled projector, AMX ICS Lan EXB device).	ON	OFF	ON	OFF

NOTE: Each toggle's ON position is toward the connectors on the rear of the DXLink Modules.

Auto-setup

NOTE: The 4K HDMI Wallplate TX does not require configuration, regardless of the configuration of any connected Receiver units.

To configure Receivers using traditional NetLinx binding (requires disabling auto-setup), see the *Hardware Reference Manual – DXLink Twisted Pair 4K Transmitters and Receivers*.

Need to Know for Auto-setup

- Receiver modules **must be** set to DHCP Mode (default)
- Receiver modules **must use** NDP Master connection mode (default)
- Receiver modules **must not be** currently bound (traditional NetLinx binding) to a Master
- Module DIP switch setting for Toggle #3 (network connectivity) is ignored while in auto-setup mode

Disabling Auto-setup Mode

Auto-setup can be disabled for DXLink endpoints by using the System Configuration interface (see the *System Configuration Interface* section on page 184) or via DGX_SHELL commands (see below).

IMPORTANT: The *DGX_SHELL* command to disable auto-setup mode does not persist over a power cycle. If your installation requires disabling auto-setup through endpoint power cycles, use the System Configuration interface for this setting.

1. Open a terminal emulation program.
2. At the prompt (DGX_SHELL>), type the command to disable auto-setup (to determine the BCPuX variable, see page 275.)
Disable all ports on an input or output board –
`set BCPuX_auto_setup_disabled=1,2,3,4`
3. **Disable port #2 on an input or output board –**
`set BCPuX_auto_setup_disabled=2`
4. **Disable all boards in the system (including DXLink Fiber) –**
`set BCPuX_auto_setup_disabled=1,2,3,4`
5. The module detects the change and reboots with auto-setup disabled.
6. Use traditional NetLinx binding to configure DXLink Receivers.

Enabling Auto-setup Mode

Auto-setup is enabled by default. If disabled, auto-setup can be enabled for DXLink Twisted Pair 4K Receivers by using the System Configuration interface (see page 143) or via DGX_SHELL commands (see below).

1. Open a terminal emulation program
2. At the prompt (DGX_SHELL>), type the command to enable auto-setup (to determine the BCPuX variable, see page 275):
Enable all ports on an input or output board –
`set BCPuX_auto_setup_disabled=,,,`
Enable port #2 on an input or output board –
`set BCPuX_auto_setup_disabled=1,3,4`
Enable all boards in the system (including DXLink Fiber) –
`set BCPuX_auto_setup_disabled=,,,`
3. The module detects the change and reboots with auto-setup enabled.

Telnet Access to Endpoints in Auto-setup Mode

DXLink Twisted Pair 4K Receiver modules in auto-setup mode are accessible through the ICS LAN port on the Switcher's CPU. Control is established through a Telnet session with appropriate Telnet commands for the DXLink Twisted Pair 4K Receiver (see the *Hardware Reference Manual – DXLink Twisted Pair 4K Transmitters and Receivers* at www.amx.com).

CAUTION: The ICS LAN port acts as a DHCP server (private LAN) and the LAN 100/1000 port acts as a DHCP client (public LAN) with each port on a separate network. In order to avoid a Network Loop, do not connect any device on one network to any branch on the other network.

IMPORTANT: If auto-setup is being used, Telnet is the only way to access some of the network settings. Also note that some network settings will disable the auto-setup feature (reference the section "Need to Know for Auto-setup" on page 132).

Telnet Access to DXLink Twisted Pair 4K Receivers

1. Connect a PC to the ICS LAN port on the left side of the Switcher's CPU.
2. Open NetLinx Studio.
3. In the OnLine Tree, listen for the 198.18.0.1 device (internal Master IP) and establish a connection.
4. Right-click the Receiver and select TELNET Window/Launch TELNET Window via NetLinx Studio.

DXLink Twisted Pair / DXLink Twisted Pair 4K Compatibility

By default, DXLink 4K Input Boards provide a 4K EDID to all connected DXLink Transmitter devices. While DXLink Transmitters are supported by the DXLink 4K Input Board, the default EDID provided to the Transmitter may result in a source device (computer, media player, etc) presenting a video resolution out of the Transmitter's range. To ensure the source device presents a resolution the DXLink Transmitter can support, simply use the Enova DGX 100 Series System Configuration interface to select a non-4K EDID (All, Wide, Full in non-4K range) to ensure a supported format is requested by the DXLink Transmitter.

NOTE: *Compatibility is available between DXLink Twisted Pair equipment and DXLink Twisted Pair 4K equipment (see the "DXLink Compatibility" Appendix in the "DXLink Twisted Pair 4K Transmitters and Receivers Hardware Reference Manual" at www.amx.com).*

Troubleshooting

NOTE: *While most monitors handle the sleep function well, some monitors continually attempt to wake up, resulting in constant or intermittent screen blanking when no video is present. For the video output attached to the problematic monitor, either uncheck the Allow Display Sleep option and set the Blank Color in the System Configuration interface (see page 127) or set VIDOUT_SLEEP-DISABLE and VIDOUT_BLANK-`<color>` (see page 228).*

NOTE: *Some older DXLink Twisted Pair Receivers are not compatible with DXLink Twisted Pair 4K Output Boards. Instructions for identifying incompatible Receivers are available on page 123.*

DXLink Fiber Input & Output Boards

Overview

This chapter pertains to DXLink Fiber Input and Output Boards (Duplex and Simplex).

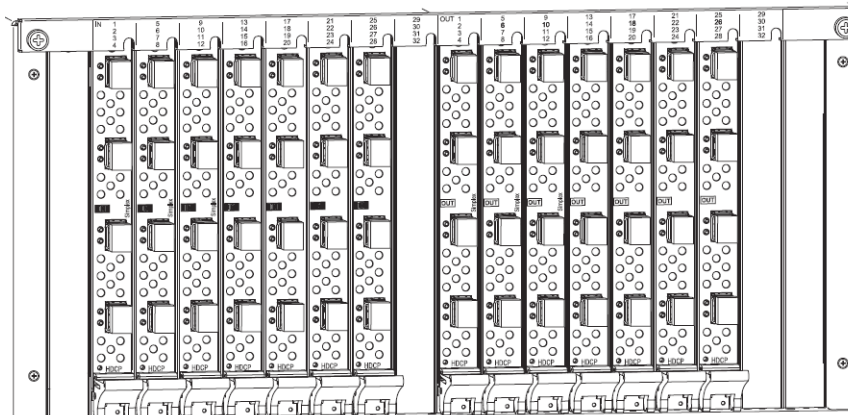

FIG. 52 DXLink Fiber Boards, Simplex and Duplex (shown with dust plugs)

DXLink Fiber Boards, Duplex

Duplex DXLink Fiber Boards handle simultaneous, bidirectional or unidirectional data transfer:

Part #	Model Name	Model Number
FG1058-622	Enova DGX DXLink Multimode Fiber Input Board, Duplex	DGX-I-DXF-MMD
FG1058-632	Enova DGX DXLink Multimode Fiber Output Board, Duplex	DGX-O-DXF-MMD
FG1058-620	Enova DGX DXLink Single Mode Fiber Input Board, Duplex	DGX-I-DXF-SMD
FG1058-630	Enova DGX DXLink Single Mode Fiber Output Board, Duplex	DGX-O-DXF-SMD

DXLink Fiber Boards, Simplex

Simplex DXLink Fiber Boards only handle unidirectional data transfer. By removing the fiber return path, Simplex hardware provides an added layer of security.

Part #	Model Name	Model Number
FG1058-623	Enova DGX DXLink Multimode Fiber Input Board, Simplex	DGX-I-DXF-MMS
FG1058-633	Enova DGX DXLink Multimode Fiber Output Board, Simplex	DGX-O-DXF-MMS
FG1058-621	Enova DGX DXLink Single Mode Fiber Input Board, Simplex	DGX-I-DXF-SMS
FG1058-631	Enova DGX DXLink Single Mode Fiber Output Board, Simplex	DGX-O-DXF-SMS,

- DXLink Fiber Boards, Duplex and Simplex have four input or output connectors per board.
- DXLink Fiber Boards, Simplex are labeled "Simplex." DXLink Fiber Boards, Duplex are not labeled.

NOTE: When powered on, Duplex transceiver LEDs are yellow and green; Simplex transceiver LEDs are blue.

Enova DGX Enclosure Support for DXLink Fiber Input and Output Boards	
DGX 800	Enova DGX 800 enclosures can hold up to four DXLink Fiber Boards. Each enclosure holds a maximum of two input and two output boards, accommodating connector configurations up to a maximum of 8x8, as well as three subsets (i.e., 4x4, 4x8, or 8x4).
DGX 1600	Enova DGX 1600 enclosures can hold up to eight DXLink Fiber Boards. Each enclosure holds a maximum of four input and four output boards, accommodating connector configurations up to a maximum of 16x16, as well as subsets (e.g., 16x8 or 4x12).
DGX 3200	Enova DGX 3200 enclosures can hold up to sixteen DXLink Fiber Boards with four inputs or outputs per board. Each enclosure holds a maximum of eight input and eight output boards, accommodating connector configurations up to a maximum of 32x32, as well as subsets (e.g., 12x24 or 32x8).
DGX 6400	Enova DGX 6400 enclosures can hold up to thirty-two DXLink Fiber Boards. Each enclosure holds a maximum of sixteen input and sixteen output boards, accommodating connector configurations up to a maximum of 64x64, as well as subsets (e.g., 12x48 or 52x8).

Warning: Optical Fiber Products

WARNING: DXLink Fiber units use laser transceivers, which are Class 1 Eye Safe per IEC 60825-1/CDRH requirements. While the Class 1 category indicates that the invisible laser used is safe, we recommend avoiding direct eye exposure when using any optical fiber products (see the OSHA directive below).

OSHA Directive

The OSHA Technical Manual (at https://www.osha.gov/dts/osta/otm/otm_iii/otm_iii_6.html) under "VI. Control Measures and Safety Programs" states: "Direct exposure on the eye by a beam of laser light should *always* be avoided with any laser, no matter how low the power."

Signal Routing

DXLink Fiber Input Boards route signals to DXLink Fiber Output Boards or to any other type of Enova DGX Output Boards. DXLink Fiber Output Boards accept signals from all types of Enova DGX Boards. When routing signals between different board types, the Enova DGX Switcher automatically converts the signal format to match the output board.

IMPORTANT: These boards are compatible only with other AMX products that support the DXLink Fiber Technology. They are not compatible with third-party optical distribution amplifiers or multimode to single mode converters.

- The following signals from a DXLink Fiber unit can be sent over DXLink Fiber Boards: HDMI, DVI-D, analog video, and digital or analog stereo audio.
- Supported analog video input signals include RGBHV, RGBS, RGsB, Y/Pb/Pr (converted to RGsB), and an RGBHV output signal.

DXLink Fiber Boards *must* be used in conjunction with DXLink Fiber units (see the compatibility table on page 135 and the system setup information on page 140). DXLink Fiber Boards also work in conjunction with AIE Boards (see page 175) or Audio Switching Boards (see page 164).

HDCP Compliance

If a connected downstream sink is not HDCP compliant, then the DXLink fiber output *will not* send the signal to it. This does not affect other outputs the source may be routed to. This allows compliant displays to show content from source devices even if the source devices are switched to non-compliant displays.

Non-compliant displays can easily be identified because they display a dark red image (via HDMI/DVI outputs) or an orange image (via a DXLink Fiber RX) to indicate that the authentication process failed.

InstaGate Pro Technology

- DXLink Fiber Boards meet HDCP standards and support InstaGate Pro Technology. For complete information on HDCP functionality for DXLink Fiber Boards, see "HDCP Support on Enova DGX Switchers" on page 98.
- DXLink Fiber Boards provide EDID emulation support with plug-and-play information provided by the Enova DGX Switcher.
- DXLink fiber input/output connectors incorporate HDMI Technology, are HDCP 1.4 compatible, feature InstaGate Pro Technology for low-latency switching of HDCP protected content, and support computer video up to 1920x1200 and HDTV up to 1080p. The DXLink fiber connectors also support embedded audio, both linear PCM (stereo audio) and non-linear PCM (Dolby Digital, Dolby TrueHD, DTS, etc.).

DXLink Fiber Hardware Compatibility

This section applies to DXLink Fiber Input or Output Boards and their corresponding TX or RX units. Connections are allowed between matching hardware (Duplex to Duplex or Simplex to Simplex) as well as between mixed hardware (Simplex to Duplex or Duplex to Simplex) as long as the constraints of multimode to multimode and single mode to single mode are maintained.

IMPORTANT: Compatibility between hardware requires matching model types: multimode to multimode and single mode to single mode.

Compatible DXLink Fiber Transmitters and Receivers

Part #	Model Name	Model Number
FG1010-362	DXLink Multi-Format Multimode Fiber Transmitter, Duplex	DXF-TX-MMD
FG1010-562	DXLink HDMI Multimode Fiber Receiver, Duplex	DXF-RX-MMD
FG1010-360	DXLink Multi-Format Single Mode Fiber Transmitter, Duplex	DXF-TX-SMD
FG1010-560	DXLink HDMI Single Mode Fiber Receiver, Duplex	DXF-RX-SMD
FG1010-363	DXLink Multi-Format Multimode Fiber Transmitter, Simplex	DXF-TX-MMS
FG1010-563	DXLink HDMI Multimode Fiber Receiver, Simplex	DXF-RX-MMS
FG1010-361	DXLink Multi-Format Single Mode Fiber Transmitter, Simplex	DXF-TX-SMS
FG1010-561	DXLink HDMI Single Mode Fiber Receiver, Simplex	DXF-RX-SMS

NOTE: On the rear of all Transmitter units, the model number is FG1010-36X; on the rear of all Receiver units, the model number is FG1010-56X.

The multimode and single mode fiber optic transceivers allow for in-the-field replacement.

DXLink Fiber Directional Modes

DXLink Fiber Directional Modes for control communication are comprised of Bidirectional Mode, Unidirectional Mode, and Data Link-lost Mode. DXLink Fiber, Duplex hardware has a default setting of Bidirectional Mode, but can be configured for Unidirectional Mode or drop into Data Link-lost Mode (when the return path is removed or not connected). DXLink Fiber, Simplex hardware is limited to Unidirectional Mode only.

NOTE: For instructions on configuring DXLink Fiber, Duplex Input and Output Boards, see "Duplex Hardware Directional Mode Configuration" on page 143. For instructions on setting Duplex TX and RX units to a particular Directional Mode, see their Hardware Reference Manual.

Bidirectional Mode

When data flows in two directions, the flow is bidirectional. For example, a source device sends audio, video, and communication data to a TX. From the TX, all three signals are sent via fiber to an input board on the switcher. The input board routes the audio and video to an output board, while the integrated Master processes the communication data. The output board sends audio and video (along with any necessary communication data) via its RX to the destination device. If needed, communication data from the destination device can return to the Master for processing via the same path.

Bidirectional is the default Directional Mode for DXLink Fiber, Duplex hardware when both fiber strands are connected. Enabling Unidirectional Mode on Duplex hardware requires sending a command to the boards (see page 144) and setting DIP switch #4 Toggle on the TX and RX units to ON.

NOTE: Removing or not connecting a return fiber path will drop the board/unit into Data Link-lost Mode (see the following page).

Unidirectional Mode

When data flows in only one direction, the flow is unidirectional, i.e., only audio/video signals travel from a TX unit via the switcher's input/output boards to an RX unit and no signals are passed back to the TX. In Unidirectional Mode, the RX does not send an optical signal trying to establish a return data path connection. Simplex hardware always operates in this mode and does not require additional setup.

Unidirectional Mode is a configurable setting for DXLink Fiber, Duplex hardware and requires sending a command to the boards (see page 143) and setting DIP switch #4 Toggle on the TX and RX to ON. Unidirectional is the only available Directional Mode for DXLink Fiber, Simplex.

NOTE: Simplex hardware is designed to only provide a single direction of data flow and not receive return data flow (i.e., transmits only video and audio signals in one direction).

Data Link-lost Mode

When Duplex hardware is configured for Bidirectional Mode (the default), but the data return path has been removed or is not connected, the hardware is in Data Link-lost Mode.

In this mode, the TX only sends audio and video via the switcher's I/O boards to the RX over a single fiber path, but the boards are actively ready for the addition of the return path which will enable Bidirectional Mode.

For example, an audio/video signal travels from a TX via the switcher's input/output boards to an RX and no signals are passed back to the TX, but the RX and input board's return lasers still transmit light and attempt to establish connections.

CAUTION: In Data Link-lost Mode, the data return path is disconnected but both transceivers' lasers are still active. If left uncovered, transceiver lasers may constitute a health hazard. This hazard should be avoided by restoring Bidirectional Mode (see page 144), configuring DXLink Fiber Boards for Unidirectional Mode (see page 143), or covering exposed lasers.

IMPORTANT: When using Duplex hardware in mixed modes (where boards and their units are configured for different Directional Modes) or using both Duplex and Simplex hardware (where the Duplex hardware is in Bidirectional Mode), we recommend that the hardware be configured to avoid Data Link-lost Mode.

Enova DGX DXLink Fiber Boards Specifications

Applies to Duplex multimode boards and Duplex single mode boards; also applies to Simplex multimode boards (input/output) and Simplex single mode boards (input/output).

DXLink Fiber, Duplex and Simplex Specifications	
Compatible Formats	HDMI video / audio / Ethernet* / USB (HID)* / control*
Signal Type Support	DXLink Fiber Connectivity between products requires matching model types, multimode to multimode or single mode to single mode.
Transport Layer Throughput	10.3125 Gbps
Video Data Rate (max.)	4.95 Gbps / 5.568 Gbps**
Video Pixel Clock (max.)	165 MHz / 185.625 MHz**
Progressive Resolution Support	480p up to 1920x1200,60Hz
Interlaced Resolution Support	480i, 576i, 1080i
2K Resolution Support	2048x1024@47Hz; 2048x1080@60Hz; 2048x1152@60Hz; 2048x1536@24Hz 2K formats are only compatible with DVI, HDMI, and DXLink Fiber Input/Output Boards and require the output or RX Scaler to be set in Bypass mode.

DXLink Fiber, Duplex and Simplex Specifications (Cont.)	
Deep Color Support	24-bit, 30-bit Note: The scaler on the corresponding output board or DXLink Fiber RX must be set to Bypass mode using CTA-861 formats and the resolution is 1080p,60 or less.
Color Space Support	<ul style="list-style-type: none"> • RGB 4:4:4 • YCbCr 4:4:4 and 4:2:2 Input signal support is for YCbCr 4:4:4 and 4:2:2; output color-space is converted to RGB 4:4:4.
3D Format Support	The scaler on the corresponding output board or DXLink Fiber RX must be set to Bypass mode. <ul style="list-style-type: none"> • Frame Packing 1080p up to 24 Hz • Frame Packing 720p up to 50/60 Hz • Frame Packing 1080i up to 50/60 Hz • Top-Bottom 1080p up to 24 Hz • Top-Bottom 720p up to 50/60 Hz • Side-by-Side Half 1080i up to 50/60 Hz
Audio Format Support	Dolby TrueHD, Dolby Digital, DTS-HD Master Audio, DTS <ul style="list-style-type: none"> • 2 CH through 8 CH L-PCM • Dolby Digital and DTS support up to 48 kHz, 5.1 channels.
Audio Resolution	16 bit to 24 bit
Audio Sample Rate	32 kHz, 44.1 kHz, 48 kHz, 96 kHz, 192 kHz
Local Audio Support	Insertion and/or extraction of 2 CH L-PCM selectable by channel
EDID Support	<ul style="list-style-type: none"> • EDID provided by an Enova DGX Digital Media Switcher to connected DXLink Fiber Transmitter • EDID is user re-programmable
HDCP Support	<ul style="list-style-type: none"> • Full matrix HDCP support (includes any input to any or all outputs) • Key Management System • AMX HDCP InstaGate Pro® Technology • Key support up to 16 destinations per output, independent of source device
USB (HID) Transport	Use the Enova DGX Digital Media Switcher in conjunction with DXLink Transmitters and Receivers (twisted pair and/or fiber). Connect a DXLink Transmitter to a PC and a DXLink Receiver to a keyboard and mouse; the system then emulates commands from the Receiver back to the PC. A list is available of HID devices which have been tested and found to be working well with the latest firmware (see "DXLink - HID supported Devices" on the DXLink Fiber Receiver's product page at www.amx.com).
CEC Support	None
ICSP, TCP/IP, USB, IR, Control Management	Control distribution is managed by the Enova DGX on-board NetLinx NX Master and Ethernet switch.
Fiber Transceiver Type	10G SFP+
Connectors	4 LC Duplex Fiber ports (used on both Duplex and Simplex boards) conforming to ANSI TIA/EIA 604-10 (FOCIS 10A) <ul style="list-style-type: none"> • On the DXLink MM / SM Duplex input and output ports, both receive and transmit portions of the SFP+ module are active. • On the DXLink MM / SM Simplex output ports, only the transmit portion of the SFP+ module is active. • On the DXLink MM / SM Simplex input ports, only the receive portion of the SFP+ module is active.
Fiber Cable Types and Supported Length	<ul style="list-style-type: none"> • Single mode models, duplex/simplex – 9/125 µm @ 6.21 miles (10 km) • Multimode models, duplex/simplex – OM3 50/125 µm @ 984 ft. (300 m)
Optical Wavelength	<ul style="list-style-type: none"> • Single mode – 1310 nm • Multimode – 850 nm
Single Mode Optical Budget	<ul style="list-style-type: none"> • 7.4 dB (typical) between DXLink Fiber transceivers • Optical Modulation Amplitude (OMA): -5.2 dBm (min.) • Optical Modulation Amplitude (OMA) Sensitivity: -12.6 dBm (typical)
Single Mode Optical Transceiver Mean Output Power	-8.2 dBm to 0.5 dBm (average power)
Multimode Optical Budget	<ul style="list-style-type: none"> • 6.8 dB (typical) between DXLink Fiber transceivers • Optical Modulation Amplitude (OMA): -4.3 dBm (min.) • Optical Modulation Amplitude (OMA) Sensitivity: -11.1 dBm (typical)
Multimode Optical Transceiver Mean Output Power	-1 dBm (average power)
DXLink Fiber Input Board Propagation Delay	5 µs
DXLink Fiber Output Board Propagation Delay	5 µs
Safety Certifications	Class 1 Eye Safe per requirements of IEC 60825-1 / CDRH

NOTE: Duplex boards/units support bidirectional control over fiber. Simplex boards/units do not support EDID transfer and control transport (such as Ethernet, USB, IR, and Serial Control) over fiber; although when used as part of a complete Enova DGX solution, control can be provided if a supplemental independent network connection is used (see page 146).

EDID Resolutions Supported through Local DDC

This section covers all of the default EDIDs. In the System Configuration interface, the EDIDs contained in this section's tables are displayed in a single dropdown menu (General section, Preferred EDID menu) and VICs are differentiated by the presence of a "p" or "i" in the format. Standard and established timings are given in the tables following, along with detailed timing blocks.

IMPORTANT: The EDID can be configured to support additional resolutions through the local DDC using the EDID options in the System Configuration interface (see page 140).

NOTE: The Consumer Technology Association (CTA) was formerly known as the Consumer Electronics Association (CEA); the CEA 861 video standard has been renamed to CTA 861.

Standard Timing Identification (Default Shipping EDID)

The default EDID can be overwritten to include a broad range of features based on installation requirements.

Resolution	Refresh Rate Max.
1920x1080*	60 Hz
1920x1200	60 Hz
1680x1050	60 Hz
1600x1200	60 Hz
1600x900	60 Hz
1400x1050	60 Hz
1440x900	60 Hz
1360x765	60 Hz
1280x1024	60 Hz
1280x900	60 Hz
1280x800	60 Hz
1280x720	60 Hz

* Preferred timing (identified in the EDID)

Established Timing

Resolution	Refresh Rate
1280x1024	75 Hz
1152x870	75 Hz
1024x768	60 Hz, 70 Hz, 75 Hz, 87 Hz
832x624	75 Hz
800x600	56 Hz, 60 Hz, 72 Hz, 75 Hz
720x400	70 Hz, 88 Hz
640x480	60 Hz, 67 Hz, 72 Hz, 75 Hz

CTA Video Information Code (VIC) Formats

VIC #	Resolution	Refresh Rate and Aspect Ratio
VIC = 1	640x480p	59.94/60 Hz 4:3
VIC = 2	720x480p	59.94/60 Hz 4:3
VIC = 3	720x480p	59.94/60 Hz 16:9
VIC = 4	1280x720p	59.94/60 Hz 16:9
VIC = 5	1920x1080i	59.94/60 Hz 16:9
VIC = 6	720(1440)x480i	59.94/60 Hz 4:3
VIC = 7	720(1440)x480i	59.94/60 Hz 16:9
VIC = 14	1440x480p	59.94/60 Hz 4:3
VIC = 15	1440x480p	59.94/60 Hz 16:9
VIC = 16	Native 1920x1080p	59.94/60 Hz 16:9
VIC = 17	720x576p	50 Hz 4:3
VIC = 18	720x576p	50 Hz 16:9
VIC = 19	1280x720p	50 Hz 16:9
VIC = 20	1920x1080i	50 Hz 16:9
VIC = 21	720(1440)x576i	50 Hz 4:3
VIC = 22	720(1440)x576i	50 Hz 16:9
VIC = 29	1440x576p	50 Hz 4:3
VIC = 30	1440x576p	50 Hz 16:9
VIC = 31	1920x1080p	50 Hz 16:9
VIC = 32	1920x1080p	23.97/24 Hz 16:9
VIC = 33	1920x1080p	25 Hz 16:9
VIC = 34	1920x1080p	29.97/30 Hz 16:9

VIC #	Resolution	Refresh Rate and Aspect Ratio
VIC = 39	1920x1080i	50 Hz 16:9
VIC = 41	1280x720p	100 Hz 16:9
VIC = 42	720x576p	100 Hz 4:3
VIC = 43	720x576p	100 Hz 16:9
VIC = 44	720(1440)x576i	100 Hz 4:3
VIC = 45	720(1440)x576i	100 Hz 16:9
VIC = 47	1280x720p	119.88/120 Hz 16:9
VIC = 48	720x480p	119.88/120 Hz 4:3
VIC = 49	720x480p	119.88/120 Hz 16:9

Audio Data Block

Channels	Sampling Frequency
Basic Audio: 2 Channel L-PCM 32, 44.1, 48 kHz	Sampling frequency at 16, 20, or 24 bits per sample

IMPORTANT: For information on troubleshooting audio, including a table on "Audio Format Support on Enova DGX Boards," see page 101.

System Setup with DXLink Fiber, Duplex and Simplex Units

DXLink Fiber Input and Output Boards *must* be used in conjunction with DXLink Fiber TX and RX units. Compatible DXLink Fiber units are listed on page 136. System setup options are listed in the table on page 46. For unit installation details, see the units' *Quick Start Guide* or *Hardware Reference Manual*.

When the TX and RX units are installed, image adjustment and EDID scaling is automatically applied. For almost every installation, the automatic features on the units result in a quality image on the monitor. If the installation has special requirements and needs additional adjustment or if you need product specifications for the modules, refer to the *Hardware Reference Manual – DXLink Fiber Transmitters and Receivers* at www.amx.com.

The distance from a DXLink Fiber TX unit to a DXLink Fiber Input Board can be up to the maximum specified in the table below and the same for the distance from the DXLink Fiber Output Board to the DXLink Fiber RX unit. The cable run length depends on the quality of the cable (see specifications in the table below, which apply to both Duplex and Simplex hardware).

DXLink Fiber Model / Cable / Distance		
Model	Cable Type	Maximum Distance
Multimode – Duplex/Simplex Models	OM3 50/125 μ m	984 ft. (300 m)
Single mode – Duplex/Simplex Models	9/125 μ m	6.21 miles (10 km)

The system setup in FIG. 53 illustrates DXLink Fiber Boards, Duplex used in conjunction with a DXLink Fiber, Duplex Transmitter and Receiver. Setup for DXLink Fiber, Simplex equipment is similar but without the return path.

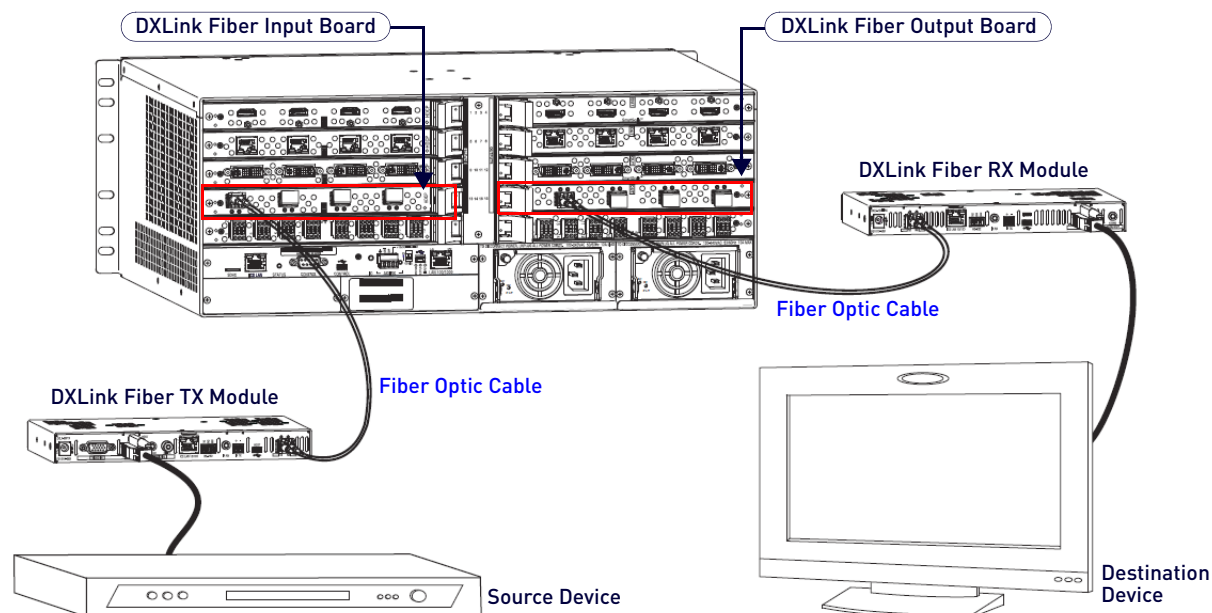

FIG. 53 DXLink Fiber Boards are used in conjunction with DXLink Fiber units

IMPORTANT: See the *DXLink Fiber Hardware Compatibility* section on page 135.

- Fiber optic cable length requirements differ between multimode and single mode. For cable length specifications, see the table above.
- For systems with special requirements – Before installing in the final location, place the equipment close together, so the Control PC and the destination monitor can be seen simultaneously if adjustments are necessary.

Destination Device Support Problems

Occasionally destination devices can cause problems in the system due to lack of signal support.

- Audio problems may result from passing Dolby or DTS or high PCM frequency rates to a destination device that does not support them.
- Video problems may result from passing a video format that the destination device does not support. In either of these cases, re-programming the EDID may help resolve the problem.

In either case, configuring the EDID may help resolve the problem (see page 140).

Connecting Switching Systems with DXLink Fiber Connectors

Enova DGX switching systems with DXLink Fiber support can be connected via their DXLink Fiber ports.

IMPORTANT: *This section does not refer to the linking of enclosures from CPU to CPU, which is not supported in the Enova DGX Switcher.*

In an installation with a multiple-stage switching system, the following applies:

- When two switching systems with DXLink Fiber support are connected via their DXLink Fiber ports, only video and audio will be passed through the DXLink Fiber connection.
- When a DXLink Fiber input or output on one switching system determines that it is connected to a DXLink Fiber input or output on another switching system, the DXLink Fiber port will automatically disable all Ethernet and control on that connection port so that the only things passed down the DXLink Fiber line are the video and audio signals.
- Compatibility between boards types from switcher to switcher *must* be maintained: multimode to multimode and single mode to single mode.
- When connecting switching systems via DXLink Fiber ports, AMX recommends no more than 3 switcher throughputs. For example, the path through 3 switchers could be: source device > Enova DGX 800 (out a DXLink Fiber port) > Enova DGX 3200, DXLink Fiber input (out a DXLink Fiber port) > Enova DGX 1600, DXLink Fiber input (out a DXLink Fiber port) > DXLink Fiber Receiver > display device as an HDMI signal.
- Network loops must be avoided (see below).

Attaching Cables

WARNING: *DXLink Fiber units use laser transceivers, which are Class 1 Eye Safe per IEC 60825-1/CDRH requirements. While the Class 1 category indicates that the invisible laser used is safe, we recommend avoiding direct eye exposure when using any optical fiber products (see the OSHA directive below).*

- Keep dust plugs in transceivers until you are ready to make a connection.
- Clean fiber optic cable ends before attaching to transceivers (be sure to follow the cable manufacturer's instructions for inspecting and cleaning the cable ends).
- Use gentle pressure when connecting fiber cables to transceivers (normally an audible click is heard when the connector engages).
- If unsure the connection is properly seated, gently tug on the transceiver.
- If fiber cables are removed from the transceivers, reinsert dust plugs.
- **Multimode transceivers only** – If you are unsure that a multimode transceiver is passing a signal, hold the unattached end of the fiber optic cable **away from you** and take a picture of it with a digital camera (or cell phone camera). The image will show a bright light if the signal is being passed (works on some digital cameras and cell phone cameras).

OSHA Directive

The *OSHA Technical Manual* (at https://www.osha.gov/dts/osta/otm/otm_iii/otm_iii_6.html) under "VI. Control Measures and Safety Programs" states: "Direct exposure on the eye by a beam of laser light should *always* be avoided with any laser, *no matter how low the power.*"

IMPORTANT: *Before attaching cables, be sure to set the DXLink Fiber unit's DIP switch toggles if necessary (see the "Hardware Reference Manual – DXLink Fiber Transmitters and Receivers").*

Wiring for Directional Modes

Fiber Optic Cable Wiring for Bidirectional Mode – Duplex Only (Default)

When wiring fiber optic cable for bidirectional full system capabilities, a dual set of fiber optic cables is used to wire from a DXLink Fiber Transmitter to a DXLink Fiber Input Board and another dual set of fiber optic cables from a DXLink Fiber Output Board to a DXLink Fiber Receiver (or directly from TX to RX). This wiring provides not only video and audio but Ethernet, IR, serial, and USB functionality as well.

Fiber Optic Cable Wiring for Unidirectional Mode – Simplex (Default) or Duplex (Configurable)

When wiring fiber optic cable for secure unidirectional system capabilities, a single fiber optic cable is used to wire from a DXLink Fiber Transmitter to a DXLink Fiber Input Board and another single fiber optic cable from a DXLink Fiber Output Board to a DXLink Fiber Receiver (or directly from TX to RX). This wiring provides video and audio only.

NOTE: *Configuring Duplex boards for secure Unidirectional Mode communication requires additional actions (see "Duplex Hardware Directional Mode Configuration" on page 143).*

Fiber Optic Cable Wiring for Data Link-lost Mode – Duplex Only

When a DXLink Fiber Duplex cable run in Bidirectional Mode has one or both ends of the fiber optic cable on the return path removed, the system automatically drops into Data Link-lost Mode. In Data Link-lost Mode, video and audio continue to flow from source to destination, but network and control no longer transmit over the fiber optic path. Restoring the cable(s) on the return path moves the system back into Bidirectional Mode.

NOTE: *Configuring Duplex boards for secure Unidirectional Mode communication requires additional actions (see "Duplex Hardware Directional Mode Configuration" on page 143).*

Fiber Optic Transceivers

Fiber optic transceivers are self-contained modules that send and receive optical signals over fiber cable. DXLink SFP+ fiber optic transceivers are either multimode or single mode and must be wired with the corresponding cable type.

NOTE: *SFP+ = enhanced small form-factor pluggable fiber optic transceiver rated at 10 Gbps transmission data rate.*

Board Types / Cable Types / Cable Runs

The type of DXLink Fiber Board determines the maximum length of cable runs possible. Cable quality is also a determining factor.

DXLink Fiber Devices			
Board Type	DGX Fiber Boards	Required Cable Type	Maximum Distance
Multimode	<ul style="list-style-type: none"> • DGX-I-DXF-MMD • DGX-O-DXF-MMD 	50/125 μ m multimode fiber optic	984 ft. (300 m)
	<ul style="list-style-type: none"> • DGX-I-DXF-MMS • DGX-O-DXF-MMS 		
Single Mode	<ul style="list-style-type: none"> • DGX-I-DXF-SMD • DGX-O-DXF-SMD 	9/125 μ m single mode fiber optic	6.21 miles (10 km)
	<ul style="list-style-type: none"> • DGX-I-DXF-SMS • DGX-O-DXF-SMS 		

All DXLink Fiber Boards are designed for transmission of an HDMI signal over fiber optic cable.

NOTE: *When powered on, Duplex transceiver LEDs are yellow and green; Simplex transceiver LEDs are blue.*

Fiber Optic Cable Requirements

- Fiber optic cable with LC termination for snap coupling with SFP+ transceivers
- Cable with LC Duplex connectors conforming to ANSI TIA-EIA 604-10 (FOCIS 10A)
- MM duplex boards require OM3 50/125 μ m multimode fiber optic cable; maximum length 984 feet (300 m)
- SM duplex boards require 9/125 μ m single mode fiber optic cable; maximum length is 6.21 miles (10 km)

NOTE: *Instructions for attaching cable management bars are on page 63. These bars are recommended and provided with each DXLink Fiber Board.*

CAUTION: *Do not severely bend or kink the fiber optic cable. Irreversible damage can occur. Refer to the physical limitations (bend radius) specified for the cable.*

Connecting DXLink Fiber Inputs and Outputs

1. Install cable management bars (see page 63).

NOTE: *Use soft ties (e.g., Velcro type hook-and-loop strips) instead of nylon cable ties, which can break fiber cables.*

2. Remove the dust plugs from the DXLink SFP+ transceiver and fiber cable connectors and save for future use.
3. Attach the fiber optic cable to the DXLink Fiber Input or Output Board's fiber optic transceiver. Normally an audible click is heard when the connector engages.
4. Tie the DXLink fiber cable to the cable management bar far enough below the connector to allow for the manufacturer's recommended bend radius (FIG. 54).

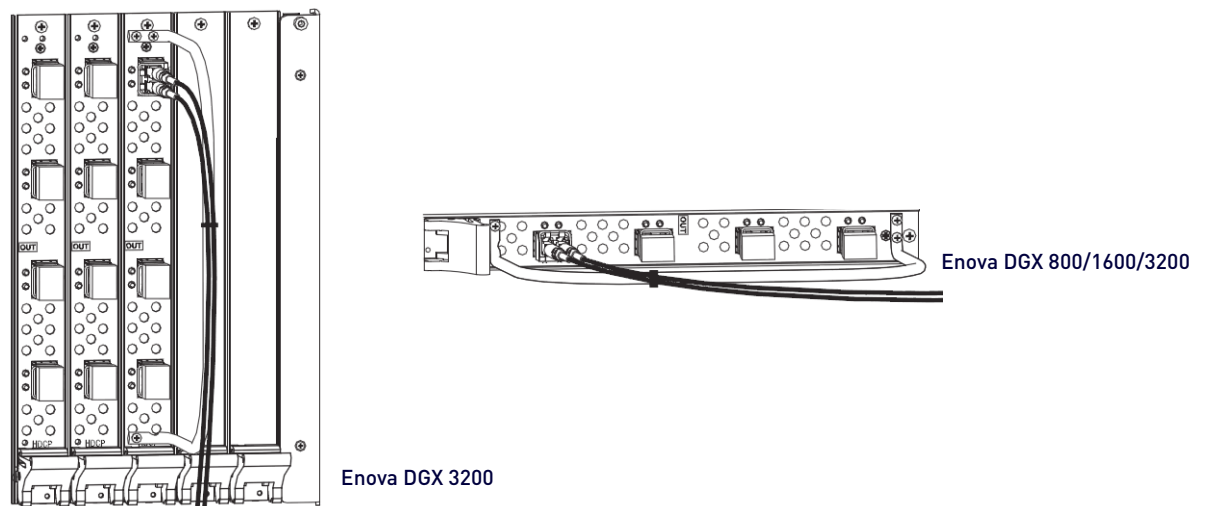

FIG. 54 Attach cables to input and output connectors (shown with cable management bar)

NOTE: Tie cable to cable management bar far enough below connection to allow for manufacturer's recommended bend radius

5. Attach the free-running end of the fiber optic cable to the transceiver on the DXLink Fiber Transmitter or Receiver.
6. Repeat the previous steps for the remaining fiber cables.

NOTE: When fiber optic transceivers are not cabled (e.g., for shipping or storage), replace the dust plugs that originally shipped with the product.

Fiber Optic Transceiver LEDs in Duplex and Simplex Hardware

DXLink Fiber Boards, Simplex are labeled "Simplex." DXLink Fiber Boards, Duplex are not labeled (FIG. 55):

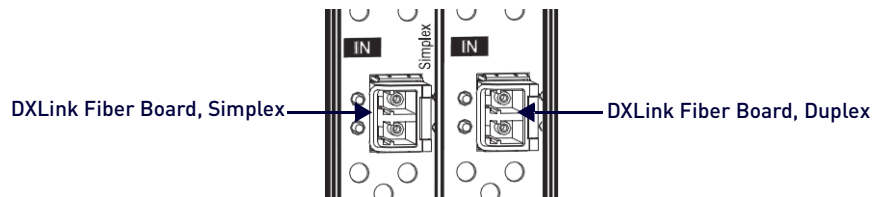

FIG. 55 DXLink Fiber Boards, Simplex and Duplex

Fiber optic transceiver LEDs have different functionality for each of the data Directional Modes (see page 136). Duplex hardware is designed for Bidirectional Mode, but can be configured for Unidirectional Mode. Simplex hardware only functions in Unidirectional Mode. When Duplex hardware in Bidirectional Mode loses its return pat, it drops into Data Link-lost Mode.

NOTE: Location of TX and RX LEDs depends on board orientation. Enova DGX 800/1600 - TX LED is right on input boards and left on output boards; RX LED is reversed. Enova DGX 3200 - TX LED is on bottom and RX is on top for both input and output boards. Enova DGX 6400 - TX LED is right on I/O boards in left side of enclosure and is left on I/O boards in right side of enclosure.

Regardless of the Directional Mode that Duplex hardware is using, the transceiver's TX LED is yellow and its RX LED is green. Simplex transceiver LEDs are always blue.

For instructions on setting Duplex hardware to a particular Directional Mode and information about each of the available modes, see "Duplex Hardware Directional Mode Configuration" on page 143.

Transceiver LEDs in Bidirectional Mode - Duplex Only

FIG. 56 describes the LEDs for the fiber optic transceiver on DXLink Fiber, Duplex Boards (and on DXLink Fiber TXs and RXs) in Bidirectional Mode as well as in Data Link-lost Mode.

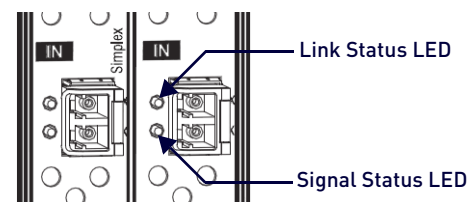

FIG. 56 DXLink Fiber Boards, Simplex and Duplex

Link Status LED	Signal Status LED
On – Link status is active	Off – No video is present
Blinking – Unit in Data Link-lost Mode <i>Note: Data Link-lost Mode occurs when hardware in Bidirectional Mode loses its return path.</i>	On (solid) – HDCP video is present
Off – Link status is not active	Fast blink – Unencrypted video is present
	Slow blink – Free-run video is present

Transceiver LEDs in Unidirectional Mode - Simplex (Default) or Duplex (Configurable)

FIG. 57 indicates the LEDs for the fiber optic transceivers on Simplex or Duplex Boards in Unidirectional Mode (also applies to transceivers on DXLink Transmitter and Receiver units).

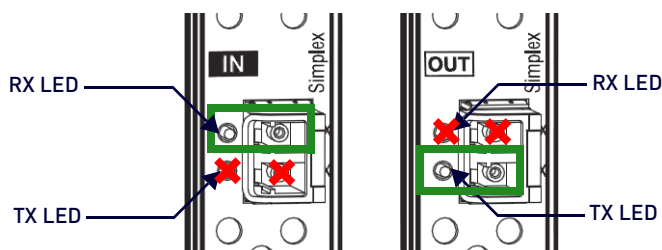

FIG. 57 Fiber optic transceiver LEDs on DXLink Fiber, Simplex Board

Input Board – Data Transport LEDs	Output Board – Data Transport LEDs
<ul style="list-style-type: none"> TX Off – Transceiver port is not operational 	<ul style="list-style-type: none"> TX On – Available for use; not sending data TX Blinking – Receiving data
<ul style="list-style-type: none"> RX On (solid) – Available for use; not receiving data Blinking – Receiving data 	<ul style="list-style-type: none"> RX Off – Transceiver port is not operational

NOTE: Only one transceiver LED, either the TX LED or the RX LED, will operate in Unidirectional Mode. The operational LED illuminates on the side of the transceiver where data enters or leaves the hardware and indicates the individual port where the fiber optic cable should be attached during cabling (see page 142).

Duplex Hardware Directional Mode Configuration

Directional Mode refers to the flow of signals and communication data within the system. The following section applies to DXLink Fiber, Duplex hardware and describes configuration of hardware for Bidirectional or Unidirectional Mode. The instructions that follow require access to the DXLink Fiber, Duplex Board(s) and associated Transmitters/Receivers and a terminal emulation program.

CAUTION: In Data Link-lost Mode, the data return path is disconnected but both of the transceivers' lasers are still active. If left uncovered, transceiver lasers may constitute a health hazard. This hazard should be avoided by restoring Bidirectional Mode (see page 144), configuring DXLink Fiber boards/units for Unidirectional Mode (see page 143), or covering exposed lasers.

Hardware Configuration

- When different pieces of DXLink Fiber, Duplex hardware are in different modes (e.g., a Transmitter in Bidirectional Mode and an Input board in Unidirectional Mode) the entire run drops into Data Link-lost Mode until the hardware is configured for matching modes.
- The only way to configure DXLink Fiber, Duplex Transmitters and Receivers for Unidirectional Mode is to adjust the setting of DIP switch #4 on the bottom of the unit. After setting the DIP switch (**ON** for Unidirectional Mode and **OFF** for Bidirectional Mode), power must be cycled to use in the enabled state.
- When Duplex and Simplex hardware are connected to one another, the Duplex hardware will always operate in Data Link-lost Mode until specifically set to Unidirectional Mode.
- Setting a Duplex board connector's configuration (to Unidirectional or Bidirectional Modes) persists between power cycles and board swaps (i.e., a board with connectors set to Unidirectional Mode will persist these settings when removed from its enclosure and added to another, while a new DXLink Fiber Board, Duplex placed in the old board's slot will not have any connectors set to Unidirectional Mode).

Configuring DXLink Duplex Hardware for Unidirectional Communication

The following directions assume that the Duplex hardware is in Bidirectional Mode. For hardware in Data Link-lost Mode, you must return the hardware to Bidirectional Mode (restore the fiber optic cables that provide the data return path) before beginning the instructions below.

- If the data return path is disconnected while the system is configured for Bidirectional Mode, the system automatically drops into Data Link-lost Mode.
- Changing the enable state (ON or OFF) on any or all channels will cause the DXLink Fiber Board to undergo a reset 5 seconds after receiving the command for it to take effect.
- A complete list of the DGX_SHELL targets, BCPuX, is in the "Product to Board Slot Correspondence" table on page 275.

DXLink Fiber Inputs or Outputs

1. Navigate to the System Configuration interface and toggle the DXLink Mode button.
2. On the Configuration Page (Switcher/Configuration), select an input or output.
3. Select the DXLink Details button on the right pane.
4. Toggle the DXLink Mode button from Bidirectional to Unidirectional.
5. Wait for the board to reboot.

Units Connected to DXLink Board Connectors

1. Place DIP switch #4 (on the bottom of Transmitters/Receivers) in the ON position to enable Unidirectional Mode
2. Cycle power to the unit(s) to reboot in Unidirectional Mode.

Configuring DXLink Duplex Hardware for Bidirectional Communication

When starting from Data Link-lost Mode or Unidirectional Mode, the following instructions explain how to restore Duplex hardware configuration to Bidirectional Mode (default). For hardware beginning in Data Link-lost Mode, simply restore the fiber optic cables that provide the data return path.

DXLink Fiber Inputs or Outputs

1. Navigate to the System Configuration interface and toggle the DXLink Mode button:
2. On the Configuration Page (Switcher/Configuration), select an input or output.
3. Select the DXLink Details button on the right pane.
4. Toggle the DXLink Mode button from Unidirectional to Bidirectional.
5. Wait for the board to reboot.

Units Connected to DXLink Board Connectors

1. Place DIP switch #4 (on the bottom of Transmitters/Receivers) in the OFF position to enable Bidirectional Mode.
2. Cycle power to the unit(s) to reboot in Bidirectional Mode.

Checking DXLink Fiber, Duplex Hardware Directional Mode Settings

Directional Mode settings on a DXLink Fiber, Duplex Input or Output Board can be checked by revisiting the DXLink Details. To discover the Directional Mode setting of a DXLink Fiber, Duplex TX or RX unit, check the #4 DIP switch on the bottom of the unit (ON = unidirectional; OFF = bidirectional).

Configuring DXLink Endpoints for Communication with a Master

DXLink TXs and RXs may be configured for communication in one of two ways: auto-setup or traditional NetLinX binding. The instructions in this section cover configuration through auto-setup. For instructions on configuring TXs and RXs through traditional NetLinX binding, see the *Hardware Reference Manual – DXLink Fiber Transmitters and Receivers*. DXLink endpoints ship with a default mode which allows auto-setup to work without additional configuration. If the endpoint has not been altered from its default settings, it should not require any of the following instructions.

Auto-setup

Use auto-setup for configuring endpoints. Auto-setup was designed to reduce the number of IP addresses consumed by a complete system. In a system that does not use auto-setup, each endpoint requires its own IP address whereas a system that uses auto-setup requires only one IP address (for the integrated Master) and each endpoint is configured for communication via a private LAN (ICS LAN) hosted by the integrated Master.

NOTE: Auto-setup is only available for DXLink endpoints capable of and configured for Bidirectional Mode. Endpoints in Unidirectional Mode should use traditional NetLinX binding (see the "Hardware Reference Manual – DXLink Fiber Transmitters and Receivers").

NOTE: For information of control signals passed through an Enova DGX with configured DXLink TX and RX, see the *Serial Data Transfer and IR Flow Control* section on page 146.

DIP Switch Toggles

DIP switch toggles for enabling/disabling special Transmitter/Receiver functionality are located on the bottom of the Transmitters and Receivers. A detailed description of functions for each toggle is provided in the *Hardware Reference Manual – DXLink Fiber Transmitters and Receivers* at www.amx.com.

Common Scenarios for Auto-setup DXLink Fiber Units	DIP Switch Settings			
	1	2	3	4
Switcher Setup – TX/RX with Enova DGX 100 Series				
AV signals with NetLinX control of TX/RX unit and serial/IR ports	OFF	OFF	OFF	OFF
AV signals with NetLinX control of TX/RX unit and serial/IR ports, plus Ethernet passthrough to networked device. With both units connected to boards in an Enova DGX Digital Media Switcher (provides integrated NetLinX control), connect the ICS LAN 10/100 port on one of the DXLink Fiber units to the network device (e.g., laptop, IP controlled projector, AMX ICSLAN EXB device).	ON	OFF	OFF	OFF

- Each toggle's ON position is toward the connectors on the rear of the DXLink Fiber TX/RX
- The default for all four DIP switch toggles is OFF

Auto-setup

- Endpoints must be set to DHCP Mode (default)
- Endpoints must use NDP Master connection mode (default)
- Endpoints must not be currently bound (traditional NetLinx binding) to a Master
- Endpoint DIP switch setting for Toggle #3 (network connectivity) is ignored while in auto-setup mode
- Auto-setup is not available for DXLink Fiber hardware in Unidirectional Mode

Disabling Auto-setup Mode

Auto-setup can be disabled for DXLink endpoints by using the System Configuration interface (see page 143) or DGX_SHELL commands (see below).

IMPORTANT: *The DGX_SHELL command to disable auto-setup mode does not persist over a power cycle. If your installation requires disabling auto-setup through endpoint power cycles, we suggest using the System Configuration interface for this setting.*

1. Open a terminal emulation program.
2. At the prompt (DGX_SHELL>), type the command to disable auto-setup (to determine the BCPuX variable, see page 275.)
 - Disable all ports on an input or output board –*
set BCPuX_auto_setup_disabled=1,2,3,4
 - Disable port #2 on an input or output board –*
set BCPuX_auto_setup_disabled=2
 - Disable all DXLink boards in the system (including DXLink Twisted Pair) –*
set BCPu_auto_setup_disabled=1,2,3,4
3. The endpoint detects the change and reboots with auto-setup disabled.
4. Use traditional NetLinx binding to configure DXLink TXs/RXs.

Enabling Auto-setup Mode

Auto-setup is enabled by default. If disabled, auto-setup can be enabled for DXLink Fiber endpoints by using either the System Configuration interface (see page 143) or DGX_SHELL commands (see below).

1. Open a terminal emulation program.
2. At the prompt (DGX_SHELL>), type the command to disable auto-setup (to determine the BCPuX variable, see page 250.)
 - Enable all ports on an input or output board –*
set BCPuX_auto_setup_disabled=,,,
 - Enable port #2 on an input or output board –*
set BCPuX_auto_setup_disabled=1,3,4
 - Enable all DXLink boards in the system (including DXLink Twisted Pair) –*
set BCPu_auto_setup_disabled=,,,
3. The endpoint(s) detects the change and reboots with auto-setup enabled.

Telnet Access to Endpoints in Auto-setup Mode

Endpoints in auto-setup mode are accessible through the ICS LAN port on the Switcher's CPU. Control is established through a Telnet session with appropriate Telnet commands for the DXLink Fiber TX/RX (see the *Hardware Reference Manual – DXLink Fiber Transmitters and Receivers* at www.amx.com).

CAUTION: *The ICS LAN port acts as a DHCP server (private LAN) and the LAN 100/1000 port acts as a DHCP client (public LAN) with each port on a separate network. In order to avoid a Network Loop, do not connect any device on one network to any branch on the other network.*

IMPORTANT: *If auto-setup is being used, Telnet is the only way to access some of the network settings. Also note that some network settings will disable the auto-setup feature (reference the section "Need to Know for Auto-setup" on page 145).*

Telnet Access to DXLink Endpoints

1. Connect a PC to the ICS LAN port on the left side of the Switcher's CPU.
2. Open NetLinx Studio.
3. In the OnLine Tree, listen for the 198.18.0.1 device (internal Master IP) and establish a connection.
4. Right-click the endpoint and select TELNET Window/Launch TELNET Window via NetLinx Studio.

NOTE: *For additional information on DXLink Fiber units, see the "Hardware Reference Manual – DXLink Fiber Transmitters and Receivers."*

Serial Data Transfer and IR Flow Control

FIG. 58 shows Bidirectional Mode serial data transfer and IR flow control when an Enova Digital Media Switcher with DXLink Fiber, Duplex Boards is used with DXLink Fiber, Duplex units. The illustration also shows the video/audio signal path. The switcher has an integrated NetLinX NX Central Control Processor which provides native AMX control at each remote location fed by a DXLink Fiber unit. Control is sent over fiber cable (via the DXLink Fiber ports).

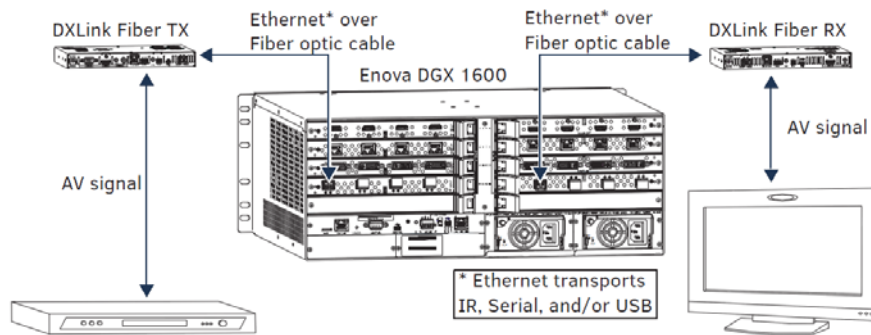

FIG. 58 Serial data transfer and IR flow control with Duplex hardware in Bidirectional Mode

IMPORTANT: For Duplex hardware in Bidirectional Mode connected to an Enova Digital media Switcher, we recommend connecting the switcher to the network for all network connection needs. Network connections via the switcher are faster and more reliable. Never connect both a TX and RX, a TX and switcher, or a switcher and RX to the same network: Avoid network loops.

NOTE: For systems with DXLink Fiber, Simplex Boards, the return path is not available.

FIG. 59 shows a DXLink Fiber TX in Unidirectional Mode and a DXLink Fiber Receiver in Bidirectional Mode with a setup that allows the units IR, USB, and serial communication via LAN when the system is in Endpoint mode with an Enova Digital Media Switcher.

NOTE: The TX can either be Duplex configured for Unidirectional Mode or Simplex, which can only support Unidirectional Mode. In either case, the fiber cable attached to the TX has no data return path.

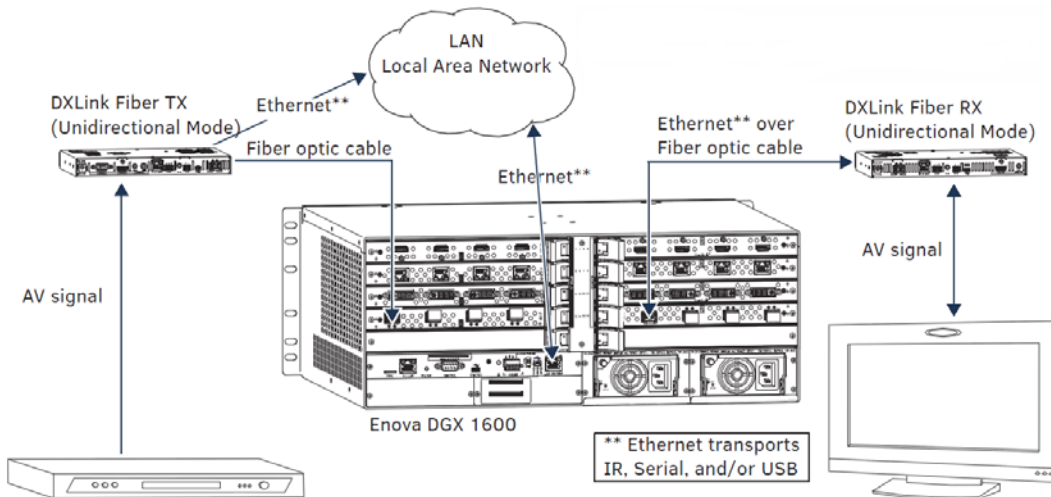

FIG. 59 Serial data transfer and IR flow control with Duplex hardware in Bidirectional Mode

IMPORTANT: The fiber cable attached to the TX only handles signals in Unidirectional Mode. The return fiber path is disabled.

CAUTION: In a source-to-destination signal run that includes hardware in more than one Directional Mode, take precautions against creating network loops with hardware in Bidirectional Mode (see page 55).

Replacing an SFP+ Fiber Optic Transceiver

This section applies to replacement of SFP+ fiber optic transceivers for DXLink Fiber boards (and DXLink Fiber units).

IMPORTANT: *Compatibility between hardware requires matching model types: multimode to multimode and single mode to single mode.*

Items Required

- Replacement SFP+ fiber optic transceiver
- DXLink Fiber Board or DXLink Fiber unit
- ESD wristband and cord with alligator clip
- ESD shielded bag for storage of removed transceiver

Multimode SFP+ Fiber Optic Transceiver

The multimode SFP+ fiber optic transceiver is used on DXLink Fiber, Duplex and Simplex Boards. Depending on the transceiver model, it will have a black latch or a black label on the latch top with white triangles showing data flow direction (FIG. 60).

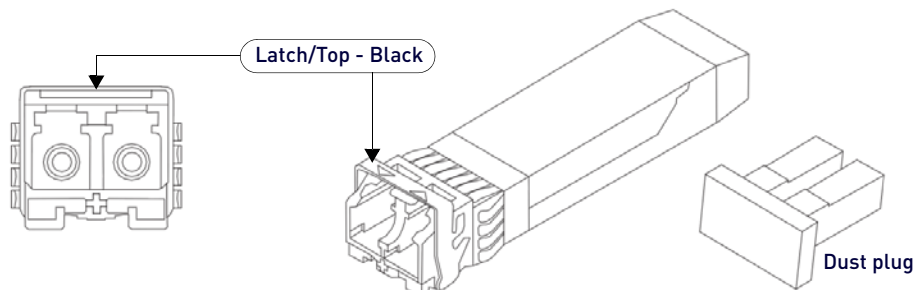

FIG. 60 Multimode SFP+ fiber optic transceiver (model with black label on latch top shown)

The multimode SFP+ fiber optic transceiver requires multimode fiber optic cable, which allows numerous optical waves to transverse the optic core. Multimode fiber optic cable has a significantly larger optical core (and therefore a higher dispersion rate) and results in comparative shorter distance runs than the single mode cable.

Single Mode SFP+ Fiber Optic Transceiver

The single mode SFP+ fiber optic transceiver is used on DXLink Fiber, Duplex and Simplex Boards. Depending on the transceiver model, it will have a bright blue latch or a blue label on the latch top with white triangles showing data flow direction (FIG. 61).

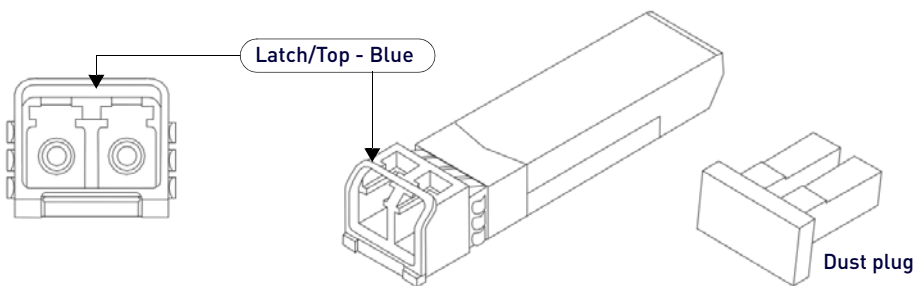

FIG. 61 Single mode SFP+ fiber optic transceiver (model with blue label on latch top shown)

The single mode SFP+ fiber optic transceiver requires single mode fiber optic cable, which allows a single optical wave to traverse through the optic core. Single mode fiber optic cable has a significantly smaller diameter optical core than multimode fiber optic cable and is generally associated with longer distance transport capabilities.

Fiber Transceiver Replacement

- Replacement transceivers must match those replaced: either multimode or single mode.
- Adding or replacing SFP+ transceivers should be done only by personnel trained to handle ESD sensitive parts and assemblies.
- If disposal of transceivers is necessary, dispose of them as mandated by your area or country guidelines.

NOTE: *When fiber optic transceivers are not cabled (e.g., for shipping or storage), replace the dust plugs that originally shipped with the product.*

ESD WARNING: *To avoid ESD (Electrostatic Discharge) damage to sensitive components, make sure you are properly grounded before touching any internal Enova DGX materials. Use an ESD wristband and cord with an alligator clip attached to a good ground source.*

NOTE: *The process for removing and replacing transceivers is the same in DXLink Fiber Boards as it is in DXLink Fiber units and the same for multimode transceivers (black latch) as it is for single mode transceivers (bright blue latch). The photographs in the procedure below show a DXLink Fiber unit.*

In the following procedure, read each step entirely. The steps include helpful tips to avoid damage to DXLink Fiber products. We also suggest reading the "Tips for Fiber Optic Connections" on page 140.

Removing/Replacing SFP+ Fiber Optic Transceivers

1. If applicable – Label and disconnect fiber optic cables (release the locking tab on the cable connector to disconnect the cable from the transceiver) or remove dust plugs from the transceiver. If cables from adjoining transceivers or boards obstruct access, label and disconnect them as necessary.
2. Using the tip of the index finger, swing the transceiver latch out and down. Note that the orientation of DXLink Fiber Boards varies from system to system (FIG. 62):

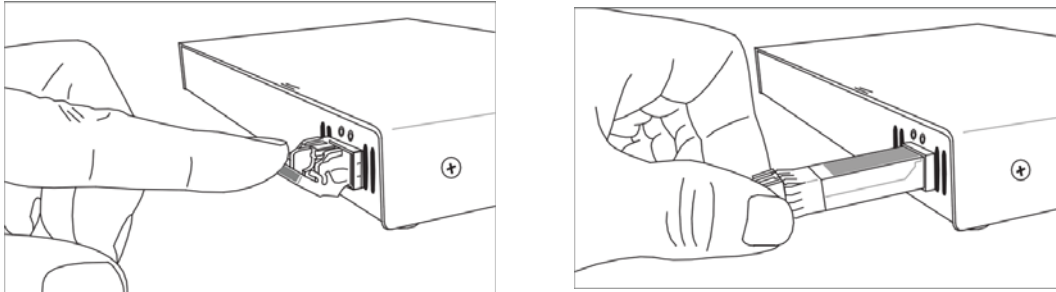

FIG. 62 Flip transceiver latch out and down, pull transceiver free from socket

3. Use the handle to release and carefully pull the transceiver completely free from its socket.
4. Restore the removed transceiver's latch to an upright position and replace the dust plug that originally shipped with the transceiver. Place the transceiver in an ESD shielded bag and set aside.

NOTE: Leave the dust plug in the replacement transceiver for Step 5 to reduce the possibility of damaging the transceiver / socket.

5. With the replacement transceiver's latch in the up (locked) position, gently insert the transceiver straight into the transceiver socket until resistance is felt (an audible click will be heard when it is fully seated).
6. Verify proper seating by gently pulling on the transceiver with the latch in the locked position.
7. Remove the dust plug and save for future use.
8. Attach the fiber cable (see page 140).
9. Test the signal path.

DXLink Fiber Troubleshooting

General Signal Problems

May be because of fiber cable quality issues. See page 141.

Audio Problems

Audio not present or intermittent with good video:

A signal containing both video and audio must have space for both signal portions. The audio signal portion lies in the blanked portion of the video signal. High Bit Rate Audio (HBRA) requires a larger than normal space in the blanked area of the signal. Video formats with reduced blanking normally provide enough space for audio signals. In a signal that combines a video format with reduced blanking and HBRA, the HBRA signal is truncated and can present as either no audio or as problematic audio (static, clicking, absent, etc.). While Enova DGX hardware supports both HBRA and reduced blanking video formats, these formats do not necessarily work with one another.

To resolve the issue, change either the audio format to non-HBRA or change the video format to a format that does not use reduced blanking.

Other audio problems:

May be a result of trying to pass Dolby, DTS, or high PCM frequency rates when the destination device does not support them. Configuring the EDID may help resolve the problem (see page 138).

Video Problems

May be a result of trying to pass a video format that the destination device does not support. Configuring the EDID may help resolve the problem (see page 138).

Check the Scaling setting on the attached RX unit to ensure it is in either Auto or Manual Mode.

Verify Optical Signal - Multimode Transceivers Only

If you are unsure that a multimode transceiver is passing a signal, hold the unattached end of the fiber optic cable **away from you** and take a picture of it with a digital camera (or cell phone camera). The image will show a bright light if the signal is being passed (works on some digital cameras and cell phone cameras).

Verify Bidirectional Mode Fiber Path - Duplex Only

With Simplex hardware or when Duplex hardware is in Unidirectional Mode, only one LED operates, either the transceiver's TX LED or RX LED. In Unidirectional Mode, the operational LED illuminates on the side of the transceiver where data enters or leaves the hardware and indicates the individual port where the fiber optic cable should be attached during cabling. If you are unsure of data being passed over fiber:

- Yellow LED: fast blink = unencrypted video present, slow blink = free-run video present, solid = HDCP video present

NOTE: *Free run video is a video mode internal to the DXLink system. When free run video is indicated, video is not displayed (nor is black video present) out the endpoint RX unit. This identifies a good connection with video flow between endpoints.*

- Green LED: solid = full bidirectional link established
- Green LED: off = link not established
- Green LED: blinking = Data Link-lost Mode (no Ethernet, RS-232, IR, or USB). If Bidirectional Mode is required, check return fiber path for proper connections and make sure DIP switch Toggle #4 is OFF.

NOTE: *When a DXLink Fiber Duplex cable run in Bidirectional Mode has one or both of the fiber optic cables on the return path removed, the system automatically drops into Data Link-lost Mode. In Data Link-lost Mode, video and audio continue to flow from source to destination, but network and control no longer transmit over the fiber optic path.*

Verify Unidirectional Mode Fiber Path

If you are unsure whether or not audio and video is being passed over fiber:

- Illuminated LED: solid = available for use; not sending audio and video (never present: Ethernet, RS-232, IR, or USB)
- Illuminated LED: blinking = receiving or transmitting audio and video (never present: Ethernet, RS-232, IR, or USB)

Verify Auto-setup Mode

If you are unsure if an endpoint has connected to the integrated Master with auto-setup, it may be because the endpoint is connected via the wrong network.

From NetLinx Studio/OnLine Tree, right-click the endpoint and select Show Device Properties from the list of available choices. Auto-setup endpoints' IP addresses reside in the 198.18.x.x space where the first "x" represents either 130 (input side) or 134 (output side) and the second "x" represents an individual port number. Non-auto-setup endpoints' IP addresses reside outside the 198.18.x.x space.

If you are sure that an endpoint has not connected to the integrated Master via auto-setup:

- It may be because the connection (board and/or endpoint) is in Unidirectional Mode or in Data Link-lost Mode.
- Restore the connection to Bidirectional Mode and reboot the input or output board.

Dante Audio Switching Boards

Overview

This chapter pertains to the following Enova DGX Dante Audio Switching Board (ASB-DAN) sets:

- **FG1061-832** Dante Audio Switching Board Set for the Enova DGX 800/1600/3200 (contains 2 boards)
- **FG1061-864** Dante Audio Switching Board Set for the Enova DGX 6400 (contains 4 boards)

Enova DGX Dante Audio Switching Boards (ASB-DAN) work in conjunction with HDMI, 4K HDMI, DVI, DXLink Fiber, DXLink Twisted Pair, and DXLink Twisted Pair 4K. Audio Switching Boards *must* be installed in the expansion board slots on the rear of the Enova DGX 100 Series enclosure.

Dante ASBs are fitted with Ethernet ports which allow the Enova DGX to send and receive up to 8 input and 8 output stereo audio paths in an Enova DGX 800/1600/3200 and up to 16 input and 16 output stereo paths in an Enova DGX 6400 to and from other Dante enabled devices. Each Dante ASB board offers a Primary and an Alternate Dante port that can be configured for fully redundant network operations.

ASB-DANs support audio-only switching and switching as embedded audio on standard video input and output boards. They also support using either type of switching from the same source device to different destination devices. In addition, all switched audio can be digitally processed (e.g., input gain, volume, equalizer).

By default, Dante devices automatically obtain DHCP IP addresses when attached to the Dante network. After making connection to the Dante network, Dante devices can be set to use Static IP (through Dante Controller software). Dante does not require a dedicated network infrastructure. Dante-enabled devices can co-exist on an existing converged data network. Dante, VoIP, and email traffic can all transmit across your business network together.

Dante Technology

Dante is a licensed technology from Audinate®. It uses standard Internet Protocols over 100Mb and/or Gigabit Ethernet and is capable of transporting professional quality, low-latency audio. Dante runs on inexpensive off-the-shelf computer networking hardware and does not require dedicated network infrastructure; Ethernet switches transmit Dante digital media streams alongside ordinary data traffic.

Dante Controller is a free application that allows you to see and make connections between Dante-enabled devices on your network. Dante Controller does not need to be present at all times for a Dante network to operate. Once the system has been set up, the Dante Controller can be shut down or removed. The routing information is stored in the Dante-enabled devices themselves.

Dante Network Configuration Considerations

When configuring the Dante network, consult Dante software's documentation for important considerations, including Dante software versions, Dante network interface port selection, and configuration of Firewall and/or Antivirus applications for Dante networks.

Dante software documentation, training, tutorials, and FAQs are available at www.audinate.com.

IMPORTANT: *Enova DGX's ICSLAN Private network (10/100 port) is not designed for use with Dante networks.*

Dante Audio Switching Boards Rules for System Setup

- Enova DGX 6400 Dante Audio Switching Boards *must* be installed in specific expansion board slots.
- Dante Audio Switching Boards *must* be installed as pairs. They *will not* work unless both an input and an output board are installed in the same enclosure (if the enclosure is an **Enova DGX 6400**, two input and two output boards are required - see FIG. 64).
- When adding Dante Audio Switching Boards to an enclosure, be sure to use the correct board set designated for the enclosure size.

CAUTION: *Audio Switching Boards, Dante Audio Switching Boards, and AIE Boards are not compatible with one other and cannot be used in the same system. If mixed types are installed in the same enclosure, the audio subsystem is disabled).*

For information on routing of audio signals (including the down-mixed audio input) using these boards, see page 160; for information on digital signal processing of the audio, see page 161.

IMPORTANT: *Adding Dante Audio Switching Boards (ASB-DAN) to an Enova DGX 100 Series Switcher changes the way that audio signals are routed. Without Audio Switching Boards, all audio signals are "embedded" and routed on video signals from an individual input to any desired output(s). With Audio Switching Boards, the Enova DGX becomes capable of routing "switched" audio independent of the associated video signal on the source's input connector. Additionally, Dante Audio Switching Boards feature the ability to pass audio from a Dante network source to any standard outputs in the Enova DGX or through the Enova DGX to a Dante network output. Information on selecting embedded vs. switched audio via the System Configuration interface is on page 137.*

Enova DGX Model Specific Dante Audio Switching Board Location

- Enova DGX 800/1600 enclosures – *Must* use one input board (in bottom left expansion slot) and one output board (in bottom right expansion slot). Boards are installed horizontally.
- Enova DGX 3200 enclosures – *Must* use one input board (in left expansion slot) and one output board (in right expansion slot). Boards are installed vertically.

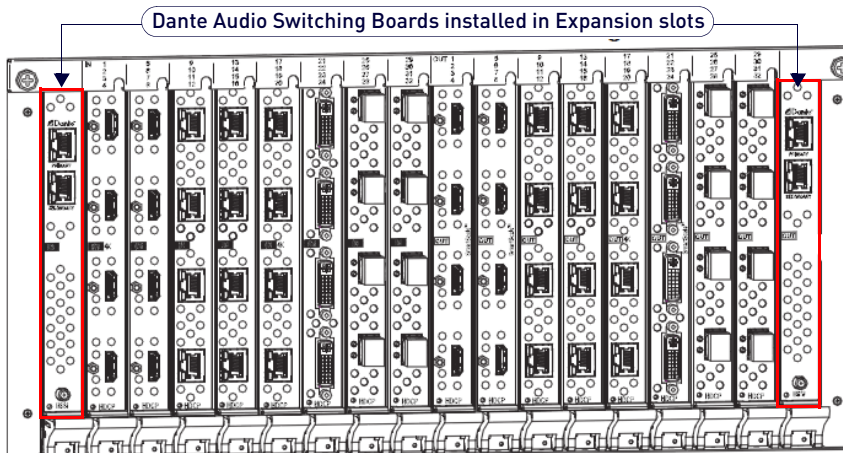

FIG. 63 Dante Audio Switching Boards - Enova DGX 3200 shown

- Enova DGX 6400 enclosures – *Must* use two input boards and two output boards in specific expansion board slots (FIG. 64). Boards are installed horizontally. Note that Enova DGX 6400 – Dante Audio Switching Input Boards must be installed directly above standard Input Boards in left and right slots and Output Boards must be installed directly below standard Output Boards in left and right slots.

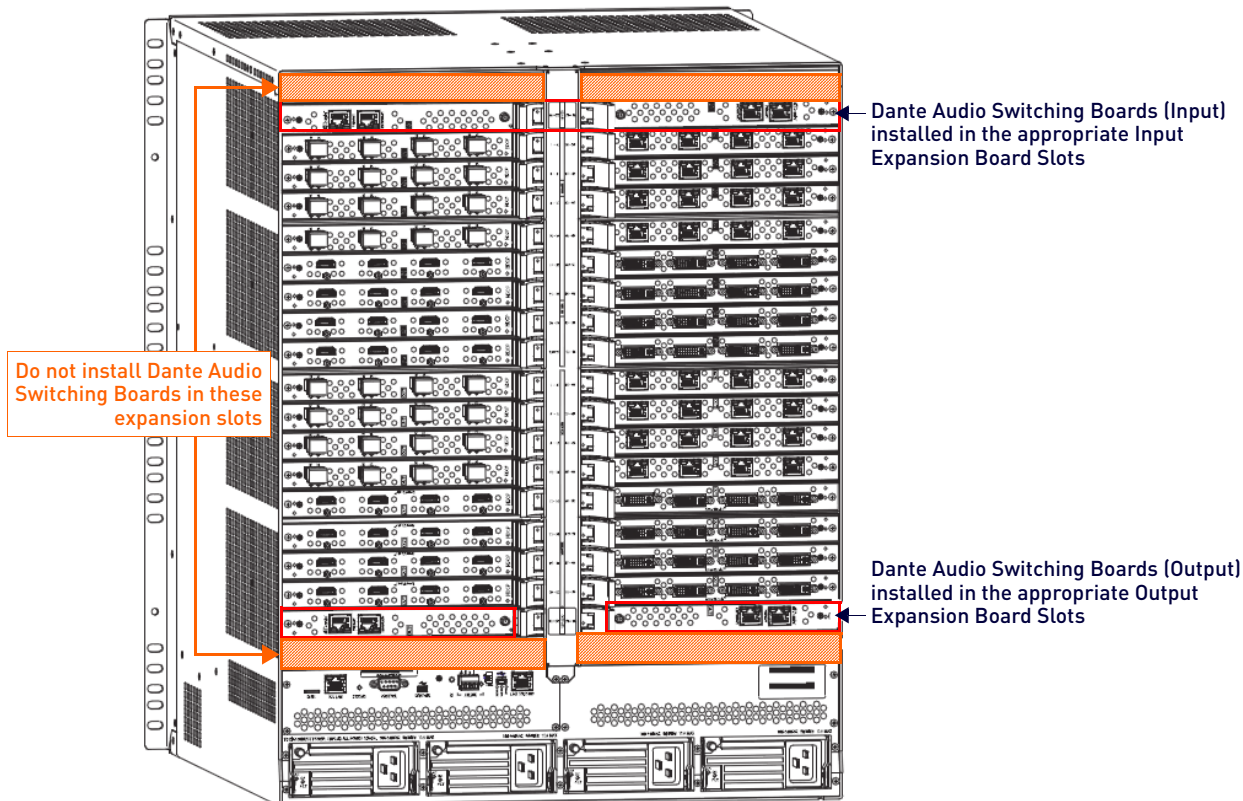

FIG. 64 Dante Audio Switching Boards - Enova DGX 6400 shown

IMPORTANT: Enova DGX 6400 – Dante Audio Switching Input Boards *must* be installed directly above standard Input Boards in left and right slots and Output Boards *must* be installed directly below standard Output Boards in left and right slots.

Dante Audio Switching Boards Specifications

The following specifications apply to Dante Audio Switching Board sets FG1061-832 and FG1061-864:

Dante Audio Switching Boards Specifications	
Compatible AMX Systems	<ul style="list-style-type: none"> • Enova DGX 100 Series Digital Media Switchers • Enova DGX 800/1600/3200 (DGX3200-ASB-DAN) • Enova DGX 6400 (DGX6400-ASB-DAN)
Compatible Enova DGX I/O Boards	<ul style="list-style-type: none"> • DGX-I-HDMI, Enova DGX HDMI Input Board (FG1058-540) • DGX-I-HDMI-4K, Enova DGX 4K HDMI Input Board (FG1061-540) • DGX-O-HDMI, Enova DGX HDMI Output Board (FG1058-550) • DGX-I-DVI, Enova DGX DVI Input Board (FG1058-600) • DGX-O-DVI, Enova DGX DVI Output Board (FG1058-610) • DGX-I-DXL, Enova DGX DXLink Twisted Pair Input Board (FG1058-570) • DGX-O-DXL, Enova DGX DXLink Twisted Pair Output Board (FG1058-580) • DGX-I-DXL-4K, Enova DGX DXLink Twisted Pair 4K Input Board (FG1061-570) • DGX-O-DXL-4K, Enova DGX DXLink Twisted Pair 4K Output Board (FG1061-580) • DGX-I-DXF-MMD, Enova DGX DXLink Multimode Fiber Input Board, Duplex (FG1058-622) • DGX-O-DXF-MMD, Enova DGX DXLink Multimode Fiber Output Board, Duplex (FG1058-632) • DGX-I-DXF-MMS, Enova DGX DXLink Multimode Fiber Input Board, Simplex (FG1058-623) • DGX-O-DXF-MMS, Enova DGX DXLink Multimode Fiber Output Board, Simplex (FG1058-633) • DGX-I-DXF-SMD, Enova DGX DXLink Single Mode Fiber Input Board, Duplex (FG1058-620) • DGX-O-DXF-SMD, Enova DGX DXLink Single Mode Fiber Output Board, Duplex (FG1058-630) • DGX-I-DXF-SMS, Enova DGX DXLink Single Mode Fiber Input Board, Simplex (FG1058-621) • DGX-O-DXF-SMS, Enova DGX DXLink Single Mode Fiber Output Board, Simplex (FG1058-631)
Audio Switching	<ul style="list-style-type: none"> • 16x16 for Enova DGX 800, 24x24 for Enova DGX 1600, • 40x40 for Enova DGX 3200, 80x80 for Enova DGX 6400 • Each embedded or auxiliary Dante audio output has independent volume, EQ, and sync delay.
Audio Inputs	<p>Auxiliary Dante Audio Input Connections:</p> <p>(2) Dante Interface RJ-45 connectors on the input board; support for redundant network or daisy chain (Dante Switched Mode) network configuration; Input board supports 8 channels of stereo audio from the Dante network into the DGX</p> <ul style="list-style-type: none"> • 8, 16 or 32 embedded digital audio inputs from video input positions (embedded audio must originate as 2 channel PCM) - Applies to embedded audio inputs on Enova DGX Input Boards for positions 1-8 (DGX 800) / 1-16 (DGX 1600) / 1-32 (DGX 3200) • 8 Auxiliary Dante stereo audio inputs on the Input Board of the Audio Switching Board Kit - Dante Audio inputs 9-16 (DGX 800), 17-24 (DGX 1600), 33-40 (DGX-3200)
Audio Outputs	<p>Auxiliary Dante Audio Output Connections:</p> <p>(2) Dante Interface RJ-45 connectors on the output board; support for redundant network or daisy chain network configuration; Output board provides 8 channels of stereo audio from the DGX into the Dante network</p> <ul style="list-style-type: none"> • 8, 16 or 32 embedded digital audio to video outputs - Applies to embedded audio outputs on Enova DGX Output Boards for positions 1-8 (DGX 800) / 1-16 (DGX 1600) / 1-32 (DGX 3200) • 8 Auxiliary Dante audio outputs on the Output Board of the Audio Switching Board Kit - Dante Audio outputs 9-16 (DGX 800), 17-24 (DGX 1600), 33-40 (DGX-3200)
Audio Adjustments per Input (embedded video and auxiliary inputs)	<p>Audio Input Compression:</p> <ul style="list-style-type: none"> • Independent Compression per input • Low, Med, High, and Custom Presets • Attack: 1 to 2000 ms • Release: 10 to 5000 ms • Compression Ratio: 1 to 20 • Threshold: -60 to 0 dB <p>Audio Input Gain Compensation: -24 dB to +24 dB, 1 dB steps</p> <p>Audio Mixing: Mono to Stereo conversion per input</p>
Audio DSP Adjustments Per Output (embedded video and auxiliary outputs)	<p>Audio Output DSP:</p> <ul style="list-style-type: none"> • Independent EQ, Volume and Balance control per output • 10-band parametric EQ with variable center frequency, filter type and Q per band Center Frequency: 20 Hz to 20 kHz EQ Gain: -12 to +12 dB Q: 0.1 to 20 Filter Types: Bell, Base Shelving, Treble Shelving, Low Pass, High Pass, Band Pass, Band Stop • Audio Output Volume adjustments with minimum and maximum limiter settings per output • Audio Output Sync Delay: 0 to 200 ms (Default 32ms) • Balance Control: 20 steps each, left and right <p>Audio Mixing: Stereo to Mono conversion per output</p> <p>Test Tone Generator: Single selection of test tone type available on all outputs simultaneously. Individually enabled/disabled per output - 60 Hz, 250 Hz, 400 Hz, 1 kHz, 3Hz, 5 kHz, 10 kHz, Pink Noise, White Noise.</p>

Dante Audio Switching Boards Specifications (Cont.)	
Dante Audio Inputs	<ul style="list-style-type: none"> • 8 Stereo Pair Inputs (16 Dante Receiver Channels) • Supported Incoming Sample Frequencies 44.1, 48, 88.2, 96, 176.4, 192 kHz at 16, 20 and 24-bit (Default set to 48kHz and 24-bit) • Clocking supports Dante Network Source Generation or Sink Locking • (2) RJ-45 1-Gbps Ports supporting Daisy Chain (Dante Switched Mode) or Redundant Modes (Daisy Chain set as default) • Latency supports 250 μsec, 500 μsec, 1 msec, 2 msec and 5 msec (1 msec default) • Device Identification supported through Dante's Identify Device (RJ-45 LED indication) • Dante Brooklyn II module
Dante Audio Outputs	<ul style="list-style-type: none"> • 8 Stereo Pair Outputs (16 Dante Transmitter Channels) • Outgoing Sample Frequency of 48 kHz at 24-bit • Clocking supports Dante Network Source Generation or Sink Locking • (2) RJ-45 1-Gbps Ports supporting Daisy Chain (Dante Switched Mode) or Redundant Modes (Daisy Chain set as default) • Latency supports 250 μsec, 500 μsec, 1 msec, 2 msec, and 5 msec (1 msec default) • Device Identification supported through Dante's Identify Device (RJ-45 LED indication) • Dante Brooklyn II module
down-mix	<ul style="list-style-type: none"> • down-mix Input: down-mix input fed from selectable embedded audio input from any Enova DGX Input Board. down-mixed audio switchable to all embedded/Dante audio outputs. • down-mix input format support: Dolby TrueHD, Dolby Digital, DTS-HD Master Audio, DTS, 2 Ch through 8 Ch L-PCM <p><i>Note: Only 2 channel L-PCM audio is supported by the Dante Audio Switching Output Board unless down-mixing is employed. All other audio formats will be muted before the output connector.</i></p>

System Examples

The examples below show typical uses for the connection of Dante network(s) to an Enova DGX via the Dante Audio Switching Boards. Enova DGX systems with Dante Audio Switching Boards are designed to route audio through the system in three ways:

Daisy Chain Topology (Default)

Dante ASB Input and Output boards are connected one to the other through the system, reducing cable requirements. Using the daisy chain topology requires changing the configuration in Dante Controller (Network Configuration Tab > toggle Redundant/Switched) which is followed by a power cycle of the Dante ASBs.

An Ethernet cable from a network switch (connected to any other Dante devices) connects to the Dante Primary Ethernet port on the Dante ASB Input board then a second run connects from the Dante Secondary Ethernet port on the Dante ASB Input board to the Dante Primary Ethernet port on the Dante ASB Output board (FIG. 65).

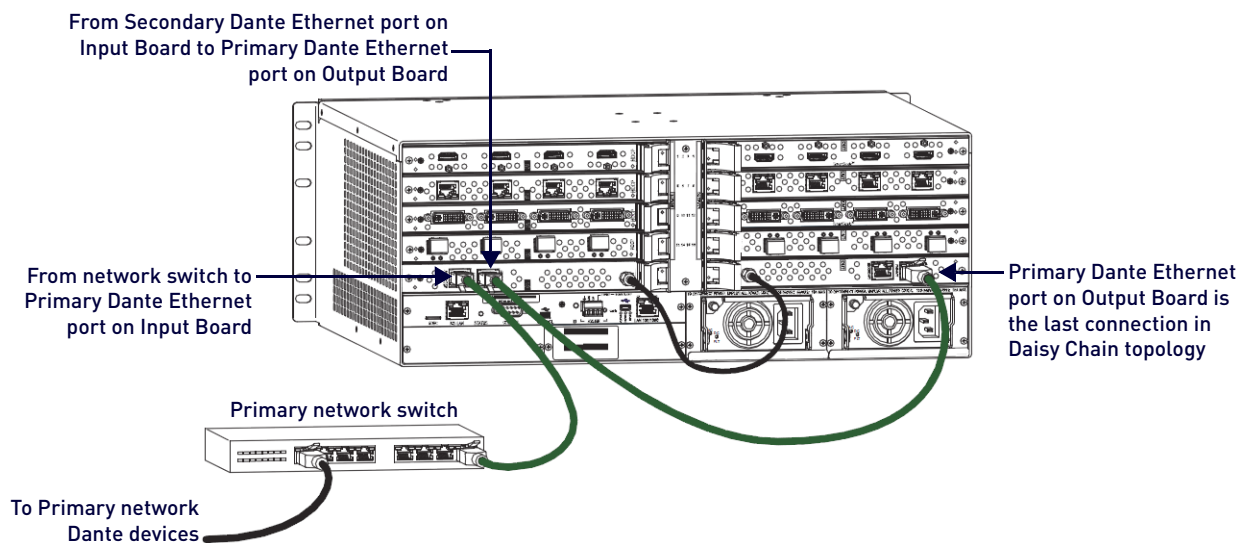
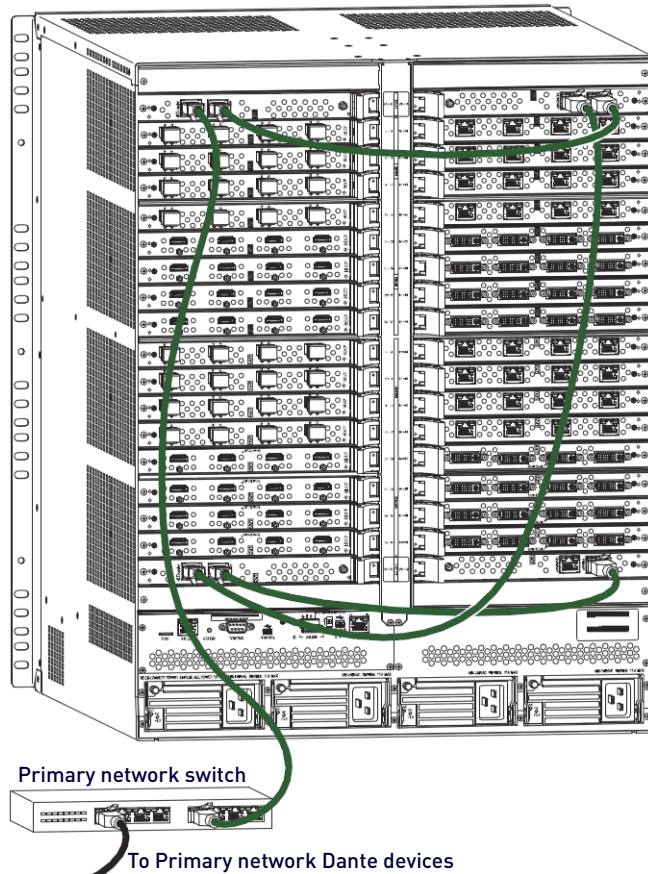

FIG. 65 Enova DGX Dante Audio Switching Boards in daisy chain topology (Enova DGX 1600 shown)

In an Enova DGX 6400, the routing path is: network switch > left input board > right input board > left output board > right output board (FIG. 66):



Routing path:

1. Network switch to left input board Primary Dante port
2. Left input board Secondary Dante port to right input board Primary Dante port
3. Right input board Secondary Dante port to left output board Primary Dante port
4. Left output board Secondary Dante port to right output board Primary Dante port

FIG. 66 Enova DGX Dante Audio Switching Boards in daisy chain topology - Enova DGX 6400

IMPORTANT: In daisy chain topology, Dante ASBs must be segmented from other Dante devices such that the run originating from a Dante network switch travels directly to the first Dante ASB in the enclosure and concludes with the last Dante ASB in the enclosure.

Star Topology without Redundancy

Dante ASB Input and Output boards are connected to a common network (via the Dante Primary Ethernet port) with or without other Dante devices. The Dante network is available to both send and receive to and from Dante ASB Inputs and Outputs.

Control of signal paths into and out of the Enova DGX is provided by the System Configuration interface (see page 137) while control of signals paths to and from the Dante network is available through Dante Controller software (available at www.audinate.com). Using the star topology requires changing the configuration in Dante Controller (Network Configuration Tab > toggle Redundant/Switched) which is followed by a power cycle of the Dante ASBs.

Each Audio Switching Board in the enclosure is connected via the Dante Primary Ethernet port to a common network (FIG. 67):

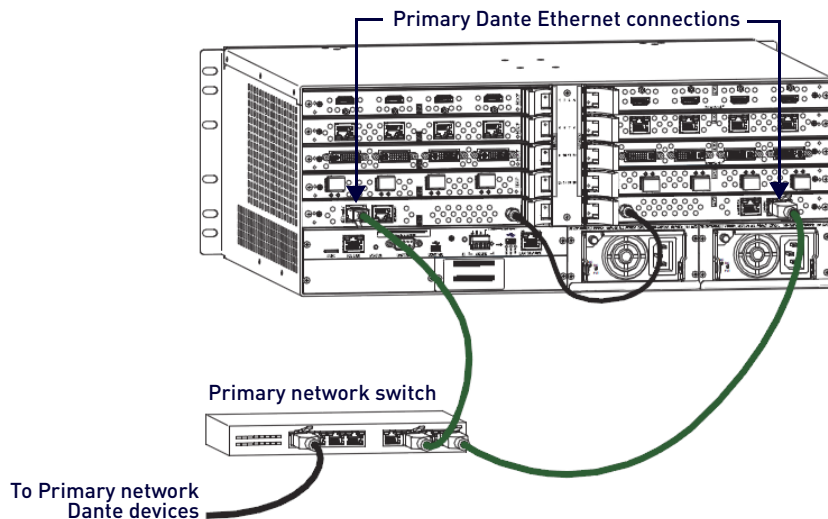

FIG. 67 Enova DGX Dante Audio Switching Boards in star topology (Enova DGX 1600 shown)

Star Topology with Redundancy

Dante ASB Input and Output boards are connected in exactly the same configuration as above, except that there is an additional connection via the Dante Secondary Ethernet port on each board to a second network. Direct control of the secondary (redundant) network is not possible while the primary network is active, though all commands sent throughout the primary network are automatically applied to the secondary network. If the primary network experiences an outage, the secondary network automatically routes to cover the outage until the primary network is brought back online. Using the star topology requires changing the configuration in Dante Controller (Network Configuration Tab > toggle Redundant/Switched) which is followed by a power cycle of the Dante ASBs.

In addition to each Dante Audio Switching Board being connected via the Dante Primary Ethernet port to a common network, each Dante ASB is connected via the Dante Secondary Ethernet port to a second network - the primary and secondary networks must not be connected (FIG. 68):

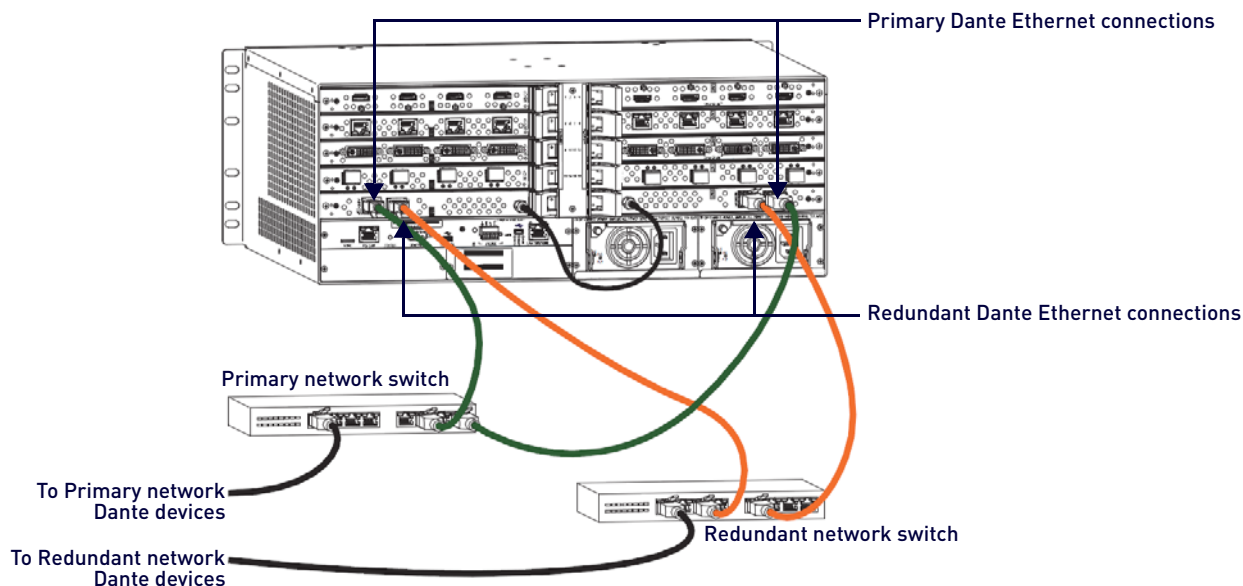

FIG. 68 Enova DGX Dante Audio Switching Boards in star topology with full redundancy (Enova DGX 1600 shown)

Dante Audio Switching Board Numbering Overlays

The Enova DGX 6400 can hold up to four Dante Audio Switching Boards (two in the lower input-side expansion board slots and two in the upper output-side expansion board slots). The Dante ASBs in the top of the enclosure work in conjunction with the Input Boards; the Dante ASBs in the bottom of the enclosure work in conjunction with the Output Boards. Overlays are provided to simplify Dante ASB connector wiring on Enova DGX 100 Series enclosures (FIG. 69):

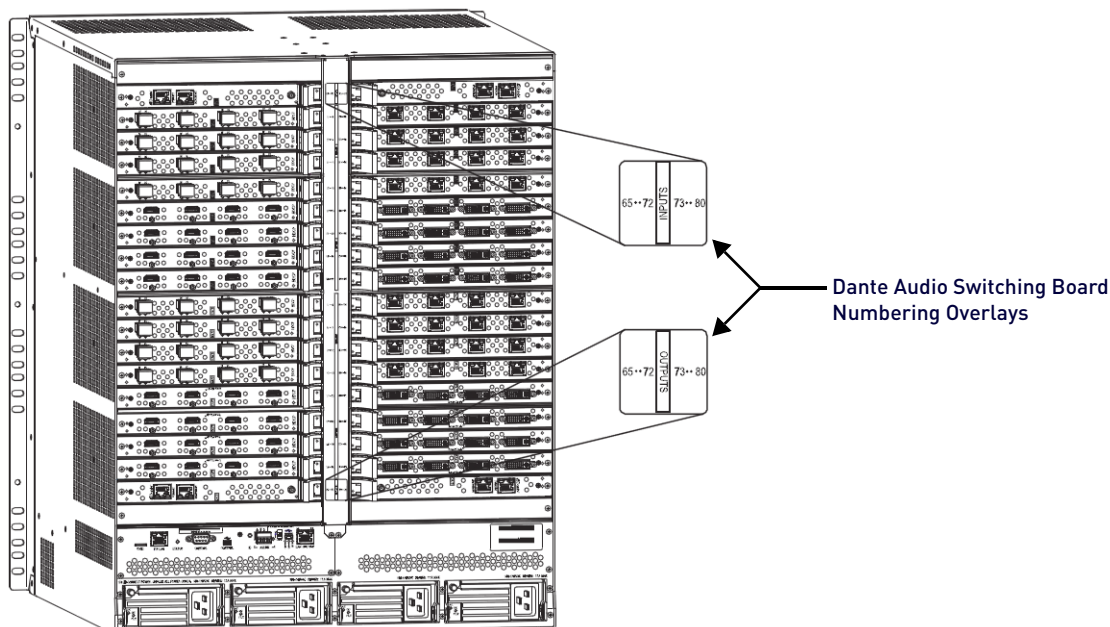

FIG. 69 Dante Audio Switching Board slot numbering overlays on Enova DGX 6400

Applying Dante ASB Overlays to Numbering Plates

1. Check the labels on the overlay to determine which system it applies to (see table below).
2. Peel the backing off the overlay and discard the backing.
3. Align the overlay carefully on the numbering plate then press firmly on the overlay to set the adhesive on the numbering plate.
4. Repeat Steps 1 through 3 as necessary for any remaining overlays.

Dante Audio Switching Board Overlay Placement

Enclosure	Audio Switching Board Numbering	Overlay Placement
Enova DGX 800	Inputs 9-16, Outputs 9-16	Vertical numbering plate (rear center) - at bottom
Enova DGX 1600	Inputs 17-24, Outputs 17-24	Vertical numbering plate (rear center) - at bottom
Enova DGX 3200	Inputs 33-40, Outputs 33-40	Horizontal numbering plate (rear top) - at left / right ends
Enova DGX 6400	Inputs 65-80, Outputs 65-80	Vertical numbering plate (rear center) - at top / bottom

Enova DGX Dante ASB to Dante Subscription Mapping

The interface from the Enova Audio Switching Matrix is fundamentally intended to be stereo (2 channel). Therefore the Dante subscription should normally be set up for both channels (Left and Right). For example, in an Enova DGX 800, to extract audio from HDMI Input 7 to Dante subscription output channels 03-LEFT and 03-RIGHT, route Input 7 to Output 11 and then make the subscription to output 03-LEFT and 03-RIGHT via Dante Control software as usual.

The following tables show the mapped relationship between the Input board's Dante subscription channel(s) and the Enova DGX stereo audio input routing number:

Enova DGX 800 Path Mapping

Enova DGX 800 Dante Audio Switching Board I/O and Dante Path Mapping			
Dante ASB Input Board		Dante ASB Output Board	
Dante Subscription (EDGX-IN)	Enova DGX ASB-DAN Input	Enova DGX ASB-DAN Output	Dante Subscription (EDGX-OUT)
Dante channels 01-LEFT,01-RIGHT	Enova Stereo Audio Input 9	Enova Stereo Audio Output 9	Dante channels 01-LEFT,01-RIGHT
Dante channels 02-LEFT,02-RIGHT	Enova Stereo Audio Input 10	Enova Stereo Audio Output 10	Dante channels 02-LEFT,02-RIGHT
Dante channels 03-LEFT,03-RIGHT	Enova Stereo Audio Input 11	Enova Stereo Audio Output 11	Dante channels 03-LEFT,03-RIGHT
Dante channels 04-LEFT,04-RIGHT	Enova Stereo Audio Input 12	Enova Stereo Audio Output 12	Dante channels 04-LEFT,04-RIGHT
Dante channels 05-LEFT,05-RIGHT	Enova Stereo Audio Input 13	Enova Stereo Audio Output 13	Dante channels 05-LEFT,05-RIGHT
Dante channels 06-LEFT,06-RIGHT	Enova Stereo Audio Input 14	Enova Stereo Audio Output 14	Dante channels 06-LEFT,06-RIGHT
Dante channels 07-LEFT,07-RIGHT	Enova Stereo Audio Input 15	Enova Stereo Audio Output 15	Dante channels 07-LEFT,07-RIGHT
Dante channels 08-LEFT,08-RIGHT	Enova Stereo Audio Input 16	Enova Stereo Audio Output 16	Dante channels 08-LEFT,08-RIGHT
	Enova Audio Input 17 (down-mix)		

Enova DGX 1600 Path Mapping

Enova DGX 1600 Dante Audio Switching Board I/O and Dante Path Mapping			
Dante ASB Input Board		Dante ASB Output Board	
Dante Subscription (EDGX-IN)	Enova DGX ASB-DAN Input	Enova DGX ASB-DAN Output	Dante Subscription (EDGX-OUT)
Dante channels 01-LEFT,01-RIGHT	Enova Stereo Audio Input 17	Enova Stereo Audio Output 17	Dante channels 01-LEFT,01-RIGHT
Dante channels 02-LEFT,02-RIGHT	Enova Stereo Audio Input 18	Enova Stereo Audio Output 18	Dante channels 02-LEFT,02-RIGHT
Dante channels 03-LEFT,03-RIGHT	Enova Stereo Audio Input 19	Enova Stereo Audio Output 19	Dante channels 03-LEFT,03-RIGHT
Dante channels 04-LEFT,04-RIGHT	Enova Stereo Audio Input 20	Enova Stereo Audio Output 20	Dante channels 04-LEFT,04-RIGHT
Dante channels 05-LEFT,05-RIGHT	Enova Stereo Audio Input 21	Enova Stereo Audio Output 21	Dante channels 05-LEFT,05-RIGHT
Dante channels 06-LEFT,06-RIGHT	Enova Stereo Audio Input 22	Enova Stereo Audio Output 22	Dante channels 06-LEFT,06-RIGHT
Dante channels 07-LEFT,07-RIGHT	Enova Stereo Audio Input 23	Enova Stereo Audio Output 23	Dante channels 07-LEFT,07-RIGHT
Dante channels 08-LEFT,08-RIGHT	Enova Stereo Audio Input 24	Enova Stereo Audio Output 24	Dante channels 08-LEFT,08-RIGHT
	Enova Audio Input 25 (down-mix)		

Enova DGX 3200 Path Mapping

Enova DGX 3200 Dante Audio Switching Board I/O and Dante Path Mapping			
Dante ASB Input Board		Dante ASB Output Board	
Dante Subscription (EDGX-IN)	Enova DGX ASB-DAN Input	Enova DGX ASB-DAN Output	Dante Subscription (EDGX-OUT)
Dante channels 01-LEFT,01-RIGHT	Enova Stereo Audio Input 33	Enova Stereo Audio Output 33	Dante channels 01-LEFT,01-RIGHT
Dante channels 02-LEFT,02-RIGHT	Enova Stereo Audio Input 34	Enova Stereo Audio Output 34	Dante channels 02-LEFT,02-RIGHT
Dante channels 03-LEFT,03-RIGHT	Enova Stereo Audio Input 35	Enova Stereo Audio Output 35	Dante channels 03-LEFT,03-RIGHT
Dante channels 04-LEFT,04-RIGHT	Enova Stereo Audio Input 36	Enova Stereo Audio Output 36	Dante channels 04-LEFT,04-RIGHT
Dante channels 05-LEFT,05-RIGHT	Enova Stereo Audio Input 37	Enova Stereo Audio Output 37	Dante channels 05-LEFT,05-RIGHT
Dante channels 06-LEFT,06-RIGHT	Enova Stereo Audio Input 38	Enova Stereo Audio Output 38	Dante channels 06-LEFT,06-RIGHT
Dante channels 07-LEFT,07-RIGHT	Enova Stereo Audio Input 39	Enova Stereo Audio Output 39	Dante channels 07-LEFT,07-RIGHT
Dante channels 08-LEFT,08-RIGHT	Enova Stereo Audio Input 40	Enova Stereo Audio Output 40	Dante channels 08-LEFT,08-RIGHT
	Enova Audio Input 41 (down-mix)		

Enova DGX 6400 Path Mapping

Enova DGX 6400 Dante Audio Switching Board I/O and Dante Path Mapping			
Dante ASB Input Board		Dante ASB Output Board	
Dante Subscription (EDGX-IN)	Enova DGX ASB-DAN Input	Enova DGX ASB-DAN Output	Dante Subscription (EDGX-OUT)
Dante channels 01-LEFT,01-RIGHT	Enova Stereo Audio Input 65	Enova Stereo Audio Output 65	Dante channels 01-LEFT,01-RIGHT
Dante channels 02-LEFT,02-RIGHT	Enova Stereo Audio Input 66	Enova Stereo Audio Output 66	Dante channels 02-LEFT,02-RIGHT
Dante channels 03-LEFT,03-RIGHT	Enova Stereo Audio Input 67	Enova Stereo Audio Output 67	Dante channels 03-LEFT,03-RIGHT
Dante channels 04-LEFT,04-RIGHT	Enova Stereo Audio Input 68	Enova Stereo Audio Output 68	Dante channels 04-LEFT,04-RIGHT
Dante channels 05-LEFT,05-RIGHT	Enova Stereo Audio Input 69	Enova Stereo Audio Output 69	Dante channels 05-LEFT,05-RIGHT
Dante channels 06-LEFT,06-RIGHT	Enova Stereo Audio Input 70	Enova Stereo Audio Output 70	Dante channels 06-LEFT,06-RIGHT
Dante channels 07-LEFT,07-RIGHT	Enova Stereo Audio Input 71	Enova Stereo Audio Output 71	Dante channels 07-LEFT,07-RIGHT
Dante channels 08-LEFT,08-RIGHT	Enova Stereo Audio Input 72	Enova Stereo Audio Output 72	Dante channels 08-LEFT,08-RIGHT
Dante channels 09-LEFT,09-RIGHT	Enova Stereo Audio Input 73	Enova Stereo Audio Output 73	Dante channels 09-LEFT,09-RIGHT
Dante channels 10-LEFT,10-RIGHT	Enova Stereo Audio Input 74	Enova Stereo Audio Output 74	Dante channels 10-LEFT,10-RIGHT
Dante channels 11-LEFT,11-RIGHT	Enova Stereo Audio Input 75	Enova Stereo Audio Output 75	Dante channels 11-LEFT,11-RIGHT
Dante channels 12-LEFT,12-RIGHT	Enova Stereo Audio Input 76	Enova Stereo Audio Output 76	Dante channels 12-LEFT,12-RIGHT
Dante channels 13-LEFT,13-RIGHT	Enova Stereo Audio Input 77	Enova Stereo Audio Output 77	Dante channels 13-LEFT,13-RIGHT
Dante channels 14-LEFT,14-RIGHT	Enova Stereo Audio Input 78	Enova Stereo Audio Output 78	Dante channels 14-LEFT,14-RIGHT
Dante channels 15-LEFT,15-RIGHT	Enova Stereo Audio Input 79	Enova Stereo Audio Output 79	Dante channels 15-LEFT,15-RIGHT
Dante channels 16-LEFT,16-RIGHT	Enova Stereo Audio Input 80	Enova Stereo Audio Output 80	Dante channels 16-LEFT,16-RIGHT
	Enova Audio Input 81 (down-mix)		

Attaching Cables

Dante Audio Switching Boards require an HSSI SMA cable (included when required) that attaches from the input board to the output board (required on all enclosure models except the Enova DGX 6400).

Dante Audio Switching Board Connectors

Dante Audio Switching Boards include two Dante Ethernet connectors (FIG. 70):

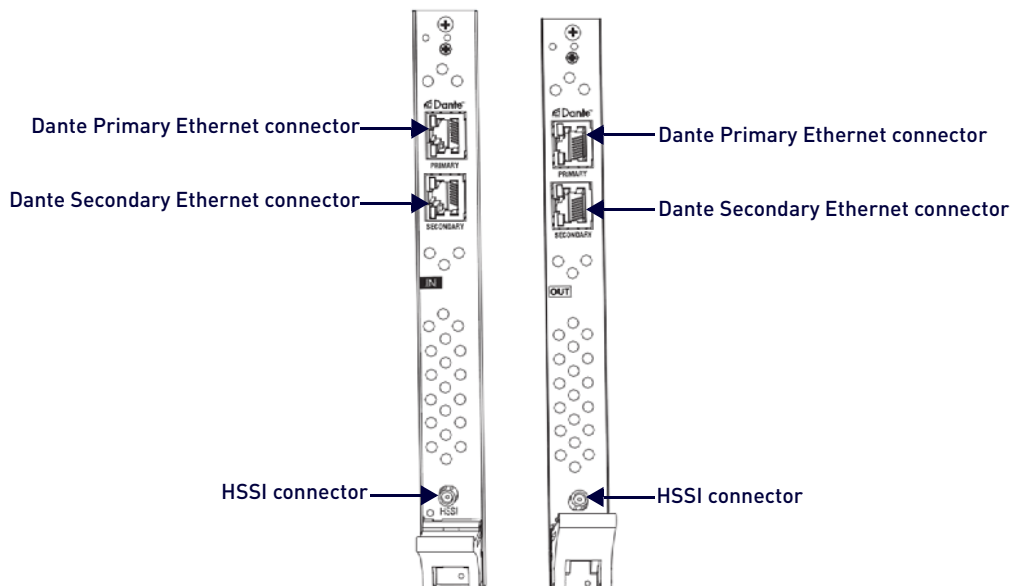

FIG. 70 Dante Audio Switching Boards - orientation and connectors

NOTE: The HSSI connector is not used on the Enova DGX 6400.

Dante Audio Switching Boards are oriented in the Enova DGX 100 Series models as follows:

- Enova DGX 800 – One each horizontal input (left) and output (right) board
- Enova DGX 1600 – One each horizontal input (left) and output (right) board
- Enova DGX 3200 – One each vertical input (left) and output (right) board
- Enova DGX 6400 – Two horizontal input boards (left and right) and two horizontal output boards (left and right)

CAUTION: Audio Switching Boards, Dante Audio Switching Boards, and Audio Insert/Extract Boards are not compatible. Do not install mixed types of expansion boards in the same enclosure. If two types of boards are present, the audio subsystem is disabled.

Dante Audio Switching Board LEDs

Dante Audio Switching Boards contain two RJ-45 ports (one Primary Dante port and one Secondary Dante port) per board (FIG. 71). Each RJ-45 port contains LEDs that indicate network connection (green) and network speed (yellow).

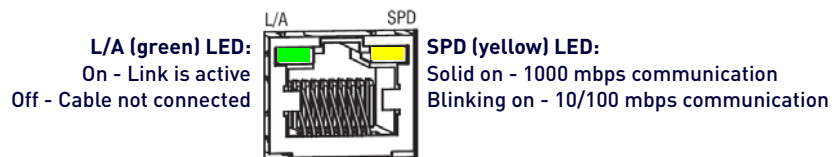

FIG. 71 Dante RJ-45 port LEDs

NOTE: Using Dante Controller's Identify Device mode (Network View>Device View>Identify button), both LEDs blink on off at 1 second intervals for 10 seconds.

Attaching the HSSI SMA (Sub-miniature version A) Cable

An HSSI (High-Speed Serial Interface) SMA cable (AMX part # 64-0051) is provided when Dante Audio Switching Boards are either purchased separately or with an enclosure. The HSSI cable attaches from the ASB input board to the ASB output board and is required on all enclosure models except the Enova DGX 6400. Do not dispose of or break this cable as Dante Audio Switching Boards will not function without it.

- While the newest Enova DGX 100 Series enclosures no longer require the HSSI cable for Dante Audio Switching Boards, it remains best practice to install the HSSI cable during initial setup of Enova DGX 800/1600/3200 systems.
- The command `?EXT_AUD` sent to 5002:1:0 responds with `TRUE` when the cable is attached and the Audio Switching Boards are fully functional.

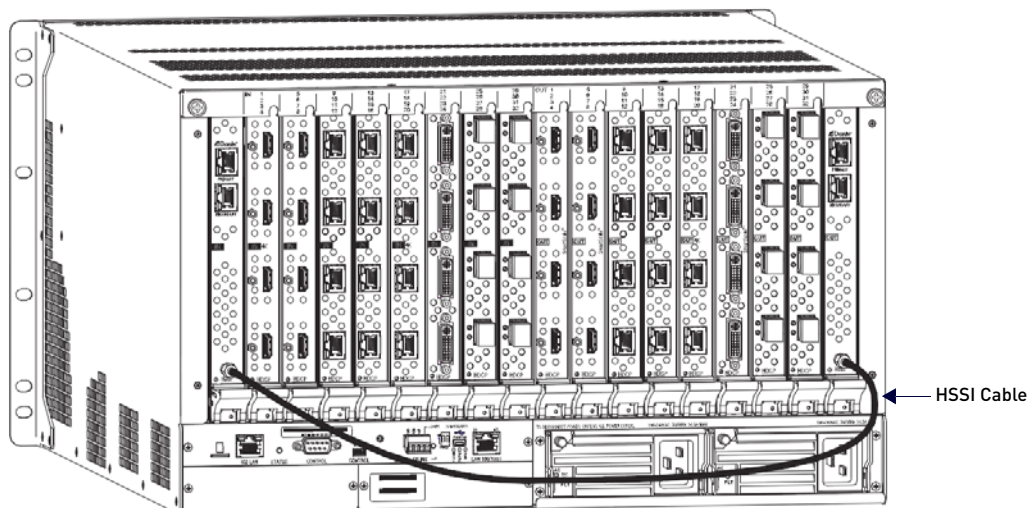

FIG. 72 Dante Audio Switching Boards with HSSI cable connected

1. Press and hold the cable connector face flat against the Audio Switching Input Board's HSSI SMA connector face.
2. Using your free hand, push cable connector's coupling nut forward until threads begin to engage between connectors.

IMPORTANT: *The cable must not be allowed to rotate while tightening the coupling nut to avoid damage to the center conductor (male pin) on the SMA connector.*

3. Rotate coupling nut clockwise until resistance is felt, being careful to avoid cross-threading coupling nut.
4. Attach free-running end of cable to Dante Audio Switching Output Board's HSSI SMA connector per Steps 1-3.
5. Test/check the routing of Dante Audio Switching Board signals (see page 161).

Routing Audio Signals

Audio Routing Capability

The audio routing capability of systems with Dante Audio Switching Boards is system dependent:

Audio Routing Capability - per System	
Enova DGX 800	16x16 audio I/Os comprised of 8 audio only I/Os and 8 video with embedded audio I/Os
Enova DGX 1600	24x24 audio I/Os comprised of 8 audio only I/Os and 16 video with embedded audio I/Os
Enova DGX 3200	40x40 audio I/Os comprised of 8 audio only I/Os and 32 video with embedded audio I/Os
Enova DGX 6400	80x80 audio I/Os comprised of 16 audio only I/Os and 64 video with embedded audio I/Os

System Configuration interface - Audio Virtual Matrix (VM 2)

In the System Configuration interface, the Audio Virtual Matrix (VM 2) is controlled by selecting the **Switch Mode: Audio** button. Virtual Matrix (VM) sizes reflect the model of the enclosure. VM 2 includes audio-only signals and audio embedded on video signals:

System Configuration interface - Audio Virtual Matrix (VM 2)	
Enova DGX 800	8x8 VMs with the exception of VM2 Audio which is 16x16
Enova DGX 1600	16x16 VMs with the exception of VM2 Audio which is 24x24
Enova DGX 3200	32x32 VMs with the exception of VM2 Audio which is 40x40
Enova DGX 6400	64x64 VMs with the exception of VM2 Audio which is 80x80

Audio Matrix I/O Paths

For routing purposes, the audio matrix I/O paths are numbered as follows:

Audio Matrix I/O Paths	
Enova DGX 800	1-8 embedded audio, 9-16 audio only, 17 down-mix audio only
Enova DGX 1600	1-16 embedded audio, 17-24 audio only, 25 down-mix audio only
Enova DGX 3200	1-32 embedded audio, 33-40 audio only, 41 down-mix audio only
Enova DGX 6400	1-64 embedded audio, 65-80 audio only, 81 down-mix audio only

- A/V and Video input and output ranges cover the basic switching size of the system: 8x8, 16x16, 32x32, or 64x64
- Audio only input and output ranges cover the embedded audio as part of the basic switching size of the system, plus the audio available on the Dante Audio Switching Boards in the expansion slots, plus the assignment of one input as a down-mixed audio path, which is routed as a separate input:

For switching audio only via the System Configuration interface, use the Audio Switch Mode (VM 2). When embedded audio is sent as audio only, each signal will be numbered according to the number of the video input or output that contains the embedded audio. Audio on the Dante Audio Switching Boards will be numbered using the numbering scheme of the video input or output number +1, +2, +3, etc. per product according to the table below.

Dante Audio Switching Boards - Routing Numbers			
Product	Board Orientation	Expansion Board Number	Connector/Routing Number
Enova DGX 800	Horizontal	Input 1	Inputs 9-16
		Output 1	Outputs 9-16
Enova DGX 1600	Horizontal	Input 1	Inputs 17-24
		Output 1	Outputs 17-24
Enova DGX 3200	Vertical	Input 1	Inputs 33-40
		Output 1	Outputs 33-40
Enova DGX 6400	Horizontal	Input 1	Inputs 65-72
		Input 2	Inputs 73-80
		Output 1	Outputs 65-72
		Output 2	Outputs 73-80

The input and output numbers in the last column in the table above are the numbers used for routing the Dante Audio Switching Board's audio paths in the Audio Switch Mode.

For example, on an Enova DGX 800: In the System Configuration interface, to route the source wired to the first connector on the Dante Audio Switching Input Board in the first input expansion slot, select the Audio Switch Mode and click Input 9. In addition, audio embedded on an HDMI video input can be routed as an embedded audio-only signal.

For example, on an Enova DGX 800: In the System Configuration interface, to route an embedded audio-only signal from the source attached to the third connector on the first HDMI Input Board, select the Audio Switch Mode and click Input 3.

Testing/Checking Audio Signal Routing

Input Board – If an embedded audio signal is being replaced on a video output signal, execute a test switch using the video signal. See the *Executing a Test Switch* section on page 70 for details.

Output Board – If audio is being pulled from a video input or output signal and sent to an auxiliary audio-only destination, check the auxiliary or supplemental audio equipment involved to be sure the audio signal is present where expected. If the system does not handle the audio in the expected manner, see "Dante Audio Switching Boards Troubleshooting" on page 162.

Digital Signal Processing (DSP)

Once the system is installed and all devices are in their final locations, the sound can be fine-tuned for optimum performance. To properly adjust the sound, signals need to be routed and volume will need to be adjusted throughout the process.

NOTE: *Before fine-tuning the system for its final location, route a few test switches to verify that the system is working correctly and to determine what type of digital signal processing adjustments are needed.*

Dante Audio Switching Boards allow for digital signal processing (e.g., input gain, volume, equalizer) on every input / output in the enclosure. All of the types of supported DSP settings (see the table that follows) can be adjusted using the System Configuration interface (see page 137). They can also be adjusted with digital signal processing SEND_COMMANDs (see page 231) or DGX_SHELL commands (see page 273). The only types of digital signal processing that are controlled via the control panel are volume, gain, and mute on embedded digital audio signals only.

Input and Output Digital Signal Processing

Input and Output Digital Signal Processing	
Digital Signal Processing	Audio Adjustment Parameters
Output Volume	-100 dB to 0 dB (attenuation)
Volume Limiter	Programmable minimum and maximum volume limits
Mute	Mute function on each output path <ul style="list-style-type: none"> When a muted output is un-muted, the output returns to its previously un-muted volume When a volume command is sent to a muted output, the output remains muted; when the output is un-muted, the volume returns at the new level
Input Gain	-24 dB to +24 dB <ul style="list-style-type: none"> Allows source signals of varying amplitudes to be equalized Inputs are set to unity gain at the factory <p>Note: <i>Make input gain adjustments before fine tuning the outputs.</i></p>
EQ Gain	-12 dB to +12 dB
Compression (Enable/Disable)	Audio inputs (when enabled) can be independently configured for the following settings: <ul style="list-style-type: none"> Attack from 1 to 2000 milliseconds Release from 10 to 5000 milliseconds Threshold of -60 dB to +0 dB Ratio 1 to 20
Delay	0 to 200 milliseconds (each audio signal independently)
10-Band Parametric Equalizer	Selectable center frequency for each band independently <ul style="list-style-type: none"> Used to boost or cut the frequencies for each output Each equalization band spans one octave and is identified by its center frequency Bands are set for a flat response (0 dB) at the factory
Preset Filter Types	Available preset filter types (apply to each band independently): Bell, Bass shelf, Treble shelf, Low pass, High pass, Band pass, Band stop,
Band Gain	-12 dB to +12 dB
Band Q	0.1 to 20
Tone	Available types of tones: Off (default), Voice, Music, Movie Note: <i>The tone adjustment is applied on top of the equalizer adjustments.</i>
Balance	Balance level can be set from -20 to +20, left to right (default value is 0)
Tone Generation (may be switched to one or more audio outputs)	Available test tones: 60 Hz, 250 Hz, 400 Hz, 1 kHz, 3 kHz, 5 kHz, 10 kHz, Pink noise, White noise

NOTE: *Configuration data is not affected by firmware upgrades.*

down-mix Audio Input

In sound recording and reproduction, down-mixing is the process by which multiple recorded paths are combined into one or more paths. In multi-track recording, multiple sound sources are recorded from separate microphones to individualized audio paths. down-mixing is the process of combining those audio paths to produce one or two paths that include all content.

Dante Audio Switching Board down-mix Input

Dante Audio Switching Output Boards provide the ability to down-mix the audio signal from one input (must be assigned as the down-mix input) to stereo audio.

The down-mixed input is fed from a single selectable embedded audio input from any Enova DGX Input Board. While the sample rate can be any valid rate, the data will be sample rate converted to 48 kHz. down-mixed audio from a single input can be switched to any or all embedded or Dante-connected audio outputs.

Supported down-mix Input Formats

- Dolby TrueHD
- Dolby Digital Plus
- Dolby Digital
- DTS-HD Master Audio
- DTS-HD High-Resolution Audio
- DTS
- 2 CH through 8 CH L-PCM

Routing the down-mix Input

The down-mix input is selected from the available audio inputs and is routed the same as any other audio input to any or all outputs (for general switching and configuration instructions, including the down-mix input, see page 130).

down-mix SEND_COMMANDS

The down-mixed audio input uses a subset of the SEND_COMMANDS available for Dante Audio Switching Boards (see below). For details on each of the SEND_COMMANDS that work with the down-mixed audio input, see the Audio Input SEND_COMMAND section on page 231.

- AUDIN_STATUS
- AUDIN_GAIN
- AUDIN_STEREO
- AUDIN_COMPRESSION
- AUDIN_COMPRESSION_ATTACK
- AUDIN_COMPRESSION_RELEASE
- AUDIN_COMPRESSION_RATIO
- AUDIN_COMPRESSION_THRESH
- ?down-mix_DOLBY_DRC
- down-mix_DOLBY_DRC
- ?down-mix_SOURCE
- down-mix_SOURCE

NOTE: *To negate a down-mix command, reroute the switch.*

Dante Audio Switching Board Troubleshooting

Switching speed or command response slows after adding Dante ASBs to the enclosure:

- Your Dante network may be attached to the Enova DGX's ICSLAN Private network. If so, the ICSLAN Port may be issuing DHCP addresses, flooding the network.
- Remove the ICSLAN from the Dante network and configure the switch on your Dante network using IGMP protocols to correctly configure your network settings (see Dante documentation at www.audinate.com).

Cannot find the Dante Audio Switching Board in Dante Controller:

- Check that the network cable is plugged in, and that the activity lights are flashing (fairly rapidly).
- Check that the correct network interfaces are selected. The selected network interfaces can be changed via the "interface selection" button in the main Dante Controller toolbar.
- Check that your network interfaces have the correct IP addresses (or set to acquire IP addresses automatically).
- Check that you have no Antivirus software installed (Dante uses 'unusual' port addresses, due to the 'usual' port addresses already being used by other common applications) - please see the Dante Controller user guide for details.
- Check that you have no firewall active - please see the Dante Controller user guide for details on how to safely configure a firewall for use in a deployed network.

To determine which physical Dante device corresponds to an entry in Dante Controller:

- Double click any device in the Network View to open the Device View, then click the Identify button. This causes LEDs on the device to flash (note that not all Dante devices support this feature).

Down-mixed audio is not present or is intermittent with good video:

- A signal containing both video and audio must have space for both signal portions. The audio signal portion lies in the blanked portion of the video signal. High Bit Rate Audio (HBRA) requires a larger than normal space in the blanked area of the signal. Video formats with reduced blanking normally provide enough space for audio signals. In a signal that combines a video format with reduced blanking and HBRA, the HBRA signal is truncated and can present as either no audio or as problematic audio (static, clicking, absent, etc.). While Enova DGX hardware supports both HBRA and reduced blanking video formats, these formats do not necessarily work with one another.
- To resolve the issue, change either the audio format to non-HBRA or change the video format to a format that does not use reduced blanking.

Dante Audio Switching Board defaults to "Embedded" rather than "Switched" audio:

- Audio Switching Boards default to Switched audio but, if the system was upgraded from Enova DGX 8/16/32/64 to 100 Series and then power cycled prior to insertion of ASB boards, the system may not recognize the correct default state.
- To resolve this issue, open the System Configuration interface and toggle the Audio Routing to its correct setting (see page 138).

If you lose audio at destinations and in Dante Virtual Soundcard / Dante Via:

- Check that all Dante hardware is powered and functioning normally.
- Stop and re-start software.

IMPORTANT: *If all Dante hardware capable of providing a Master Clock on the Dante network is removed from the network (even a short interruption), software dependent on the Master Clock for syncing will remain out-of-sync until all of the software's processes are stopped and re-started (where the software sends a fresh request to the Master Clock).*

ASB Audio Switching Boards

Overview

This chapter pertains to the following Enova DGX Audio Switching Board (ASB) sets:

- **FG1061-716** Audio Switching Board Set for the Enova DGX 800/1600 (contains 2 boards)
- **FG1061-732** Audio Switching Board Set for the Enova DGX 3200 (contains 2 boards)
- **FG1061-764** Audio Switching Board Set for the Enova DGX 6400 (contains 4 boards)

Enova DGX Audio Switching Boards (ASB) work in conjunction with HDMI, 4K HDMI, DVI, DXLink Fiber, DXLink Twisted Pair, and DXLink Twisted Pair 4K. Audio Switching Boards *must* be installed in the expansion board slots on the rear of the Enova DGX 100 Series enclosure. Each board provides eight balanced/unbalanced stereo audio line-level signals.

Audio Switching Boards support audio-only switching and switching as embedded audio on standard video input and output boards. They also support using either type of switching from the same source device to different destination devices. In addition, the embedded audio can be digitally processed (e.g., input gain, volume, equalizer).

NOTE: *Audio Switching Boards can only be purchased in board sets and must be installed in specific expansion board slots as an input and output pair, or pairs when used in an Enova DGX 6400*

Rules for System Setup

- Audio Switching Boards *must* be installed as pairs. They *will not* work unless both an input and an output board are installed in the same enclosure (if the enclosure is an **Enova DGX 6400**, two input and two output boards are required).
- When adding ASB Boards to an enclosure, be sure to use the correct board set designated for the enclosure size (see "Applicability" above).
- Enova DGX 6400 Audio Switching Boards *must* be installed in the expansion board slots (see FIG. 74 on page 165).
- Individual connectors on Audio Switching Boards can be configured for digital signal processing (see page 172).
- Audio signals can be routed from any of the standard video input board connectors (embedded audio) or from any of the terminal block connectors (audio only) on the Audio Switching Input Board to: (1) any of the standard video output board connectors, (2) any of the terminal block connectors on the Audio Switching Output Board, or (3) a combination of standard video output connectors and terminal block connectors.
- Audio Switching Boards, Dante Audio Switching Boards, and Audio Insert/Extract Boards are not compatible. Do not install mixed types of expansion boards in the same enclosure. If two types of boards are present, the audio subsystem is disabled.

For information on routing of audio signals (including the down-mixed audio input) using these boards, see page 171; for information on digital signal processing of the audio, see page 172.

IMPORTANT: *Adding Audio Switching Boards (ASB) to an Enova DGX 100 Series Switcher changes the way that audio signals are routed. With embedded audio, audio transported on a video signal, the audio must originate as 2 channel L-PCM. On the ASB external connectors, only 2 channel analog stereo audio from 2 channel L-PCM audio is supported. All other audio formats are muted before the signals are routed to output connectors (including both standard video outputs and ASB external output connectors), with the exception of one audio input signal (down-mix audio input) that can be routed to any or all outputs. All audio signals from any of the Switcher's output connectors (except down-mix audio routed outputs) are formatted as 2 channel L-PCM. For most users, this is the desired format. If you need a format on a particular input or output connector that is not supported by the Audio Switching Boards (in addition to the down-mix audio input), change the audio routing method from Switched to Embedded in the System Configuration interface's Audio Routing options (page 195).*

Enova DGX Model Specific Audio Switching Board Location

- Enova DGX 800/1600 enclosures – *Must* use one input board (in left expansion slot) and one output board (in right expansion slot). Boards are installed horizontally.
- Enova DGX 3200 enclosures – *Must* use one input board (in left expansion slot) and one output board (in right expansion slot). Boards are installed vertically.

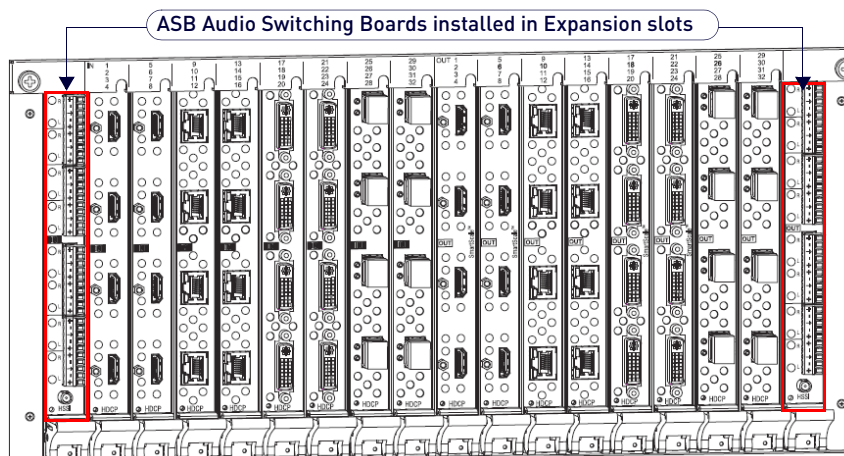

FIG. 73 ASB Audio Switching Boards - Enova DGX 3200 shown

- Enova DGX 6400 enclosures – *Must* use two input boards and two output boards in specific expansion board slots (FIG. 74). Boards are installed horizontally:

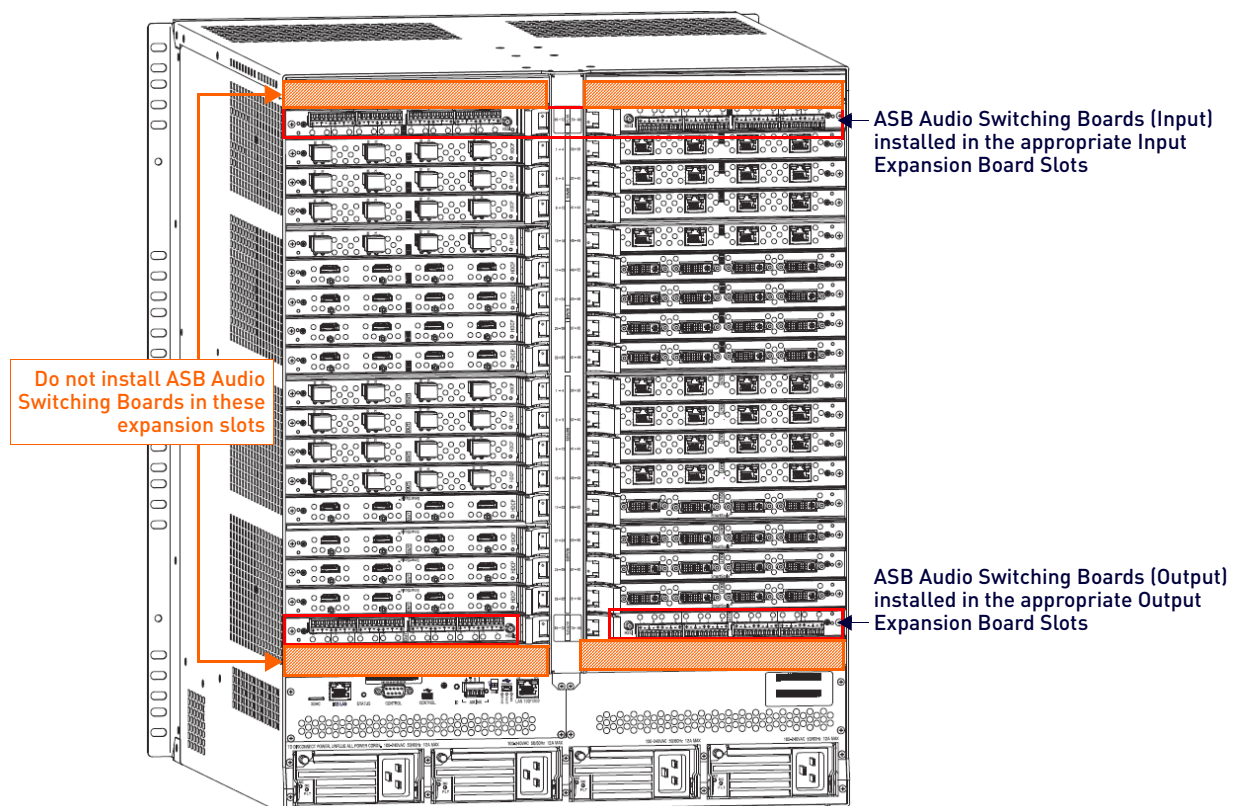

FIG. 74 ASB Audio Switching Boards - Enova DGX 6400 shown

CAUTION: Enova DGX 6400 – Audio Switching Input Boards must be installed directly above standard Input Boards in left and right slots and Output Boards must be installed directly below standard Output Boards in left and right slots. See the example in the figure above.

Enova DGX Audio Switching Boards - Specifications

Applies to Audio Switching Board sets FG1061-716, FG1061-732, and FG1061-764:

Dante Audio Switching Boards Specifications	
Compatible AMX Systems	Enova DGX 100 Series Digital Media Switchers: <ul style="list-style-type: none"> • Enova DGX 800/1600 (DGX800-ASB/DGX1600-ASB) • Enova DGX 3200 (DGX3200-ASB) • Enova DGX 6400 (DGX6400-ASB)
Compatible Enova DGX I/O Boards	<ul style="list-style-type: none"> • DGX-I-HDMI, Enova DGX HDMI Input Board (FG1058-540) • DGX-I-HDMI-4K, Enova DGX 4K HDMI Input Board (FG1061-540) • DGX-O-HDMI, Enova DGX HDMI Output Board (FG1058-550) • DGX-I-DVI, Enova DGX DVI Input Board (FG1058-600) • DGX-O-DVI, Enova DGX DVI Output Board (FG1058-610) • DGX-I-DXL, Enova DGX DXLink Twisted Pair Input Board (FG1058-570) • DGX-O-DXL, Enova DGX DXLink Twisted Pair Output Board (FG1058-580) • DGX-I-DXL-4K, Enova DGX DXLink Twisted Pair 4K Input Board (FG1061-570) • DGX-O-DXL-4K, Enova DGX DXLink Twisted Pair 4K Output Board (FG1061-580) • DGX-I-DXF-MMD, Enova DGX DXLink Multimode Fiber Input Board, Duplex (FG1058-622) • DGX-O-DXF-MMD, Enova DGX DXLink Multimode Fiber Output Board, Duplex (FG1058-632) • DGX-I-DXF-MMS, Enova DGX DXLink Multimode Fiber Input Board, Simplex (FG1058-623) • DGX-O-DXF-MMS, Enova DGX DXLink Multimode Fiber Output Board, Simplex (FG1058-633) • DGX-I-DXF-SMD, Enova DGX DXLink Single Mode Fiber Input Board, Duplex (FG1058-620) • DGX-O-DXF-SMD, Enova DGX DXLink Single Mode Fiber Output Board, Duplex (FG1058-630) • DGX-I-DXF-SMS, Enova DGX DXLink Single Mode Fiber Input Board, Simplex (FG1058-621) • DGX-O-DXF-SMS, Enova DGX DXLink Single Mode Fiber Output Board, Simplex (FG1058-631)
Audio Switching	16x16 for Enova DGX 800, 24x24 for Enova DGX 1600, 40x40 for Enova DGX 3200, 80x80 for Enova DGX 6400
Auxiliary Audio Connections	3.5 mm 10-position captive-wire terminals (4 per board); support balanced (differential) or unbalanced (single-ended) stereo audio
Embedded Digital Audio	<ul style="list-style-type: none"> • Enova DGX 800: Audio inputs on Enova DGX Input Boards for positions 1-8 and outputs on Enova DGX Output Boards for positions 1-8. • Enova DGX 1600: Audio inputs on Enova DGX Input Boards for positions 1-16 and outputs on Enova DGX Output Boards for positions 1-16. • Enova DGX 3200: Audio inputs on Enova DGX Input Boards for positions 1-32 and outputs on Enova DGX Output Boards for positions 1-32. • Enova DGX 6400: Audio inputs on Enova DGX Input Boards for positions 1-64 and outputs on Enova DGX Output Boards for positions 1-64. <p><i>Note: Embedded audio must originate as 2 channel L-PCM unless down-mixing is employed.</i></p>
down-mix	<ul style="list-style-type: none"> • down-mix Input: down-mix input fed from selectable embedded audio input from any Enova DGX Input Board. Down-mixed audio switchable to all embedded/Dante audio outputs. • down-mix input format support: Dolby TrueHD, Dolby Digital, DTS-HD Master Audio, DTS, 2 Ch through 8 Ch L-PCM <p><i>Note: Only 2 channel L-PCM audio is supported by the Dante Audio Switching Output Board unless down-mixing is employed. All other audio formats will be muted before the output connector.</i></p>

Audio Switching Boards - Inputs	
Audio Adjustments per Input (Embedded and Auxiliary Inputs)	
Audio Input Compression	<ul style="list-style-type: none"> • Independent Compression per input • Attack: 1 to 2000 ms • Release: 10 to 5000 ms • Compression Ratio: 1 to 20 • Threshold: -60 to 0 dB
Audio Input Gain Compensation	-24 dB to +24 dB, 1 dB steps
Auxiliary Analog Audio Inputs	
Input Level (Nominal)	+4 dBu (1.228 Vrms) balanced or -10 dBV (0.3162 Vrms) unbalanced
Input Level (Maximum)	+14 dBu
Input Impedance	<ul style="list-style-type: none"> • >17 kOhms balanced • >10 kOhms unbalanced
Audio Channel Crosstalk	<ul style="list-style-type: none"> • Balanced Line Inputs: -98 dB @ 0 dBV, 20 Hz to 20 kHz • Unbalanced Line Inputs: -70 dB @ 0 dBV, 20 Hz to 20 kHz

Audio Switching Boards - Outputs	
Audio Adjustments per Output (Embedded and Auxiliary Outputs)	
Audio Output Compression	<ul style="list-style-type: none"> • 10-band parametric EQ with variable center frequency, filter type and Q per band • Center Frequency: 20 Hz to 20 kHz • EQ Gain: -12 to +12 dB • Q: 0.1 to 20 • Filter Types: Bell, Bass Shelving, Treble Shelving, Low Pass, High Pass, Band Pass, Band Stop
Audio Output Sync Delay	0 to 200 ms
Balance Control	Balance level can be set from -20 to +20, left to right (default value is 0)
Audio Control per Output	Independent EQ, Volume, and balance control per output
Test Tone Generator	Single selection of test tone type available on all outputs simultaneously. Individually enabled/disabled per output – 60 Hz, 250 Hz, 400 Hz, 1 kHz, 3 kHz, 5 kHz, 10 kHz, Pink Noise, White Noise
Auxiliary Analog Audio Outputs	
Output Level (Maximum)	+17 dBu
Output Impedance	200 Ohms (line level)
Audio Frequency Response	Line: 20 Hz to 20 kHz +/-0.1 dB
Audio S/N Ratio	Line: 105 dB @ 10 dBV, AES17
Audio THD+N	Line: 0.003% @ 0 dBV, 1 kHz

System Examples

The examples below show typical uses for the audio replacement and routing functions of the Audio Switching Board. Directions for wiring the terminal block connectors are on page 169 and for cabling the HSSI SMA connector are on page 171. Enova DGX systems with Audio Switching Boards are designed to route audio through the system in three ways:

- **Embedded Audio** – An audio signal from an Audio Switching Input Board can be embedded on a video signal and then routed to any or all of the standard video output boards.
- **Audio Only** – An audio-only signal from an ASB Input Board can be routed to any or all of the ASB Output Boards.
- **All Audio** – All audio signals (embedded or audio-only) are available to route to any or all destinations.

Embedded Audio - Replacing Embedded Audio on Video Signals

The Audio Switching Boards replace embedded audio on a standard video board (HDMI shown) with an audio-only signal from an auxiliary audio source. The HDMI video signal is routed to a destination with the original video signal and the replaced embedded audio signal (FIG. 75). This behavior is enabled by default.

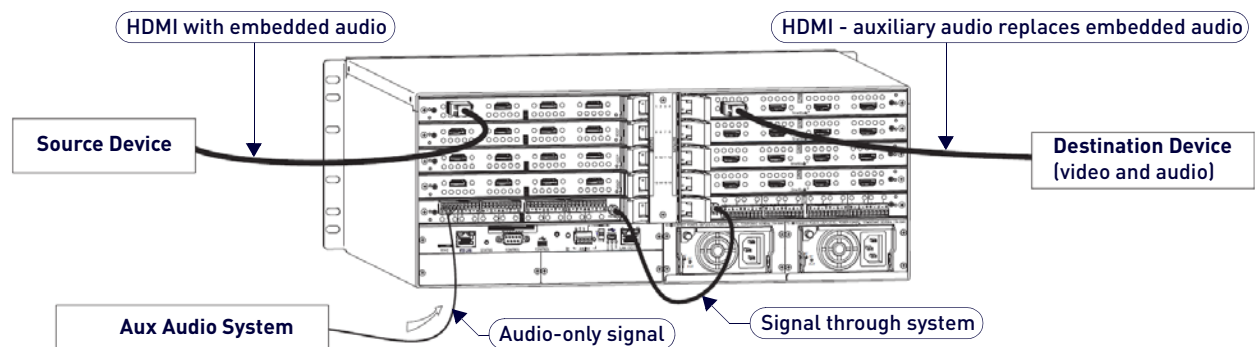

FIG. 75 Audio on the HDMI input signal replaced with auxiliary audio and routed to destination device

Audio Only - Audio Only from Source to Destination Device

The Audio Switching Input Board can route from connected sources directly to the Audio Switching Output Board and from there to connected audio destination devices (FIG. 76).

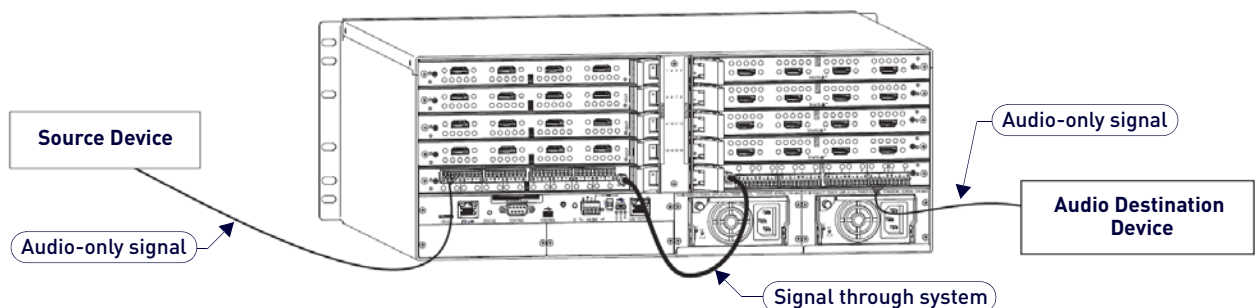

FIG. 76 Audio input signal routed to audio destination device

All Audio (Embedded or Audio Only) - Routing to Differing Types of Destination Devices

The Audio Switching Output Board can route the HDMI embedded audio signal from an HDMI Input Board to an audio-only destination (its breakaway function) while the HDMI embedded audio signal remains intact from the HDMI Output Board to another destination device or devices (FIG. 77):

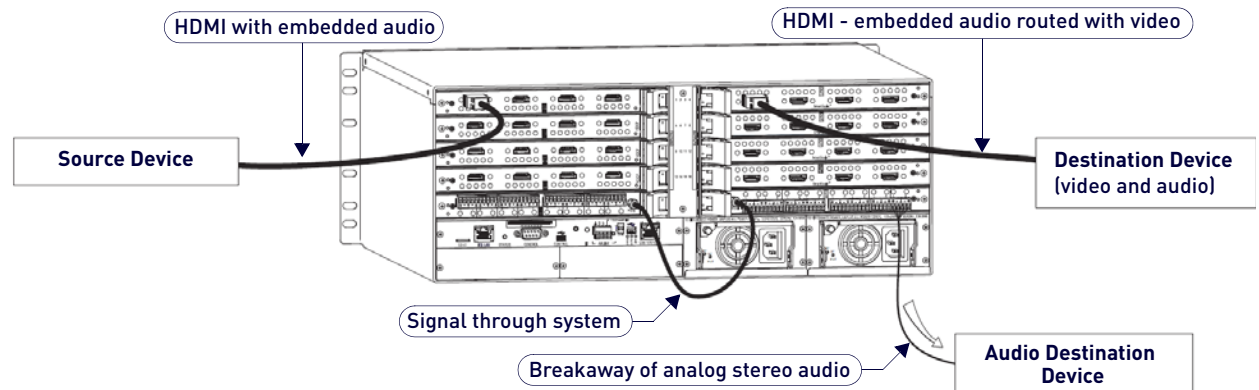

FIG. 77 Audio Switching Boards routing audio on HDMI input signal to both video destination and audio-only destination

IMPORTANT: When audio is routed as a breakaway signal from an HDMI signal, the audio also remains intact as embedded audio on the HDMI signal.

Audio Switching Board Numbering Overlays

The Enova DGX 6400 can hold up to four Audio Switching Boards (two in the lower input-side expansion board slots and two in the upper output-side expansion board slots). The Audio Switching Boards in the top of the enclosure work in conjunction with the Input Boards; the Audio Switching Boards in the bottom of the enclosure work in conjunction with the Output Boards. Overlays are provided to simplify Audio Switching Board connector wiring on the Enova DGX 100 Series enclosures that contain ASB boards (FIG. 78):

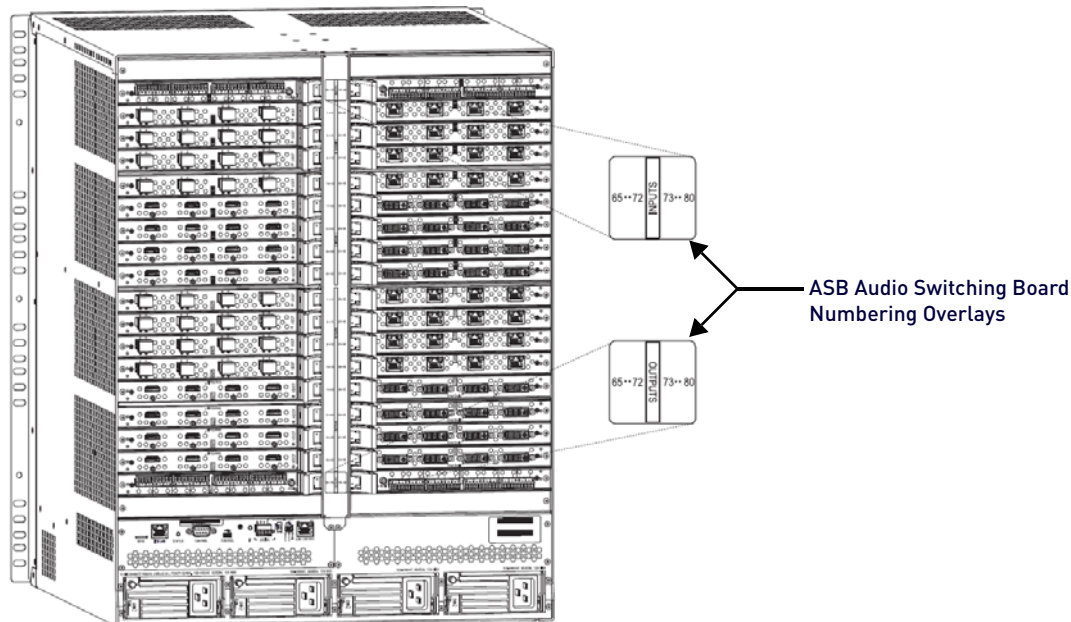

FIG. 78 ASB Audio Switching Board slot numbering overlays on Enova DGX 6400

Applying ASB Overlays to Numbering Plates

1. Check the labels on the overlay to determine which system it applies to (see table below).
2. Peel the backing off the overlay and discard the backing.
3. Align the overlay carefully on the numbering plate and then press firmly on the overlay to set the adhesive on the numbering plate.
4. Repeat Steps 1 through 3 as necessary for any remaining overlays.

Audio Switching Board Overlay Placement

Enclosure	Audio Switching Board Numbering	Overlay Placement
Enova DGX 800	Inputs 9-16, Outputs 9-16	Vertical numbering plate (rear center) - at bottom
Enova DGX 1600	Inputs 17-24, Outputs 17-24	Vertical numbering plate (rear center) - at bottom
Enova DGX 3200	Inputs 33-40, Outputs 33-40	Horizontal numbering plate (rear top) - at left / right ends
Enova DGX 6400	Inputs 65-80, Outputs 65-80	Vertical numbering plate (rear center) - at top / bottom

Attaching Wires/Cables

When attaching audio wires to terminal block audio connectors, you may find it easier to unplug the audio connectors before you start. Audio Switching Boards also require an HSSI SMA cable (included when required) that attaches from the input board to the output board (required on all enclosure models except the Enova DGX 6400). Each board provides eight balanced/unbalanced stereo audio line-level signals. For audio connector specifications, see page 166.

Audio Switching Board Connectors

Audio Switching Boards include four audio connectors. Each audio connector is a double 5-pin captive screw terminal block (L+, L-, Ground, R-, R+). Each board also includes one HSSI SMA connector (not used on the Enova DGX 6400). (FIG. 79):

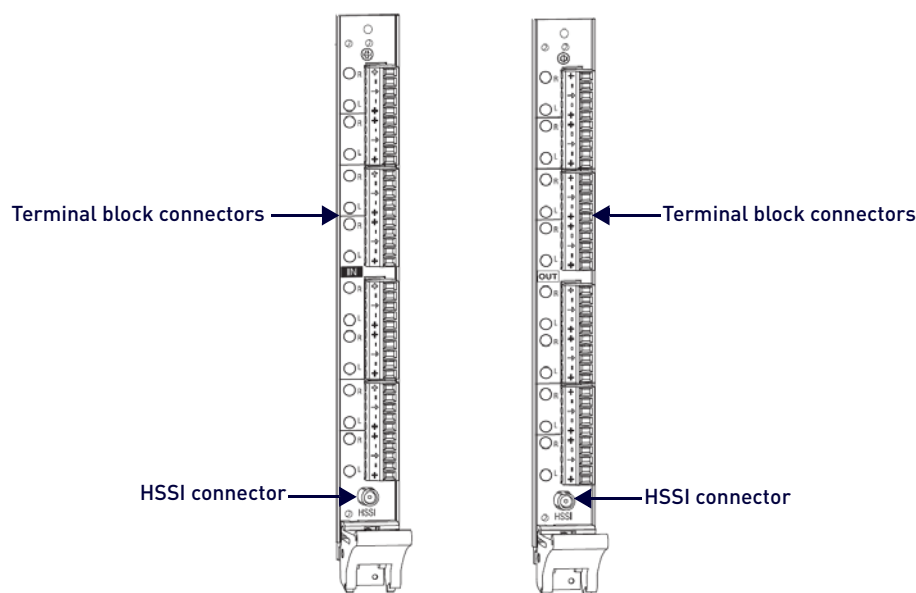

FIG. 79 Dante Audio Switching Boards - orientation and connectors

NOTE: The HSSI connector is not used on the Enova DGX 6400.

ASB Boards are oriented in the Enova DGX 100 Series models as follows:

- Enova DGX 800 – One each horizontal input (left) and output (right) board
- Enova DGX 1600 – One each horizontal input (left) and output (right) board
- Enova DGX 3200 – One each vertical input (left) and output (right) board
- Enova DGX 6400 – Two horizontal input boards (left and right) and two horizontal output boards (left and right)

CAUTION: Audio Switching Boards, Dante Audio Switching Boards, and Audio Insert/Extract Boards are not compatible. Do not install mixed types of expansion boards in the same enclosure. If two types of boards are present, the audio subsystem is disabled.

Attaching Terminal Block Audio Connectors

Important to Know When Wiring Audio Switching Board Terminal Block Connectors

- ASB Boards/connectors are positioned horizontally on the Enova DGX 800/1600/6400 and vertically on the Enova DGX 3200.
- Be sure to note the labeling: The "L" (left channel) and "R" (right channel) are each ordered: +, -, ground, -, +.

Wiring Audio Connectors

1. Loosen the captive screw on the side of the terminal block connection point.

CAUTION: Connecting ASB output left and Right channels to the same point to obtain a single channel may damage the ASB Board.

2. Insert the bare or stripped wire ends into the appropriate slots.
3. Firmly tighten the screw.

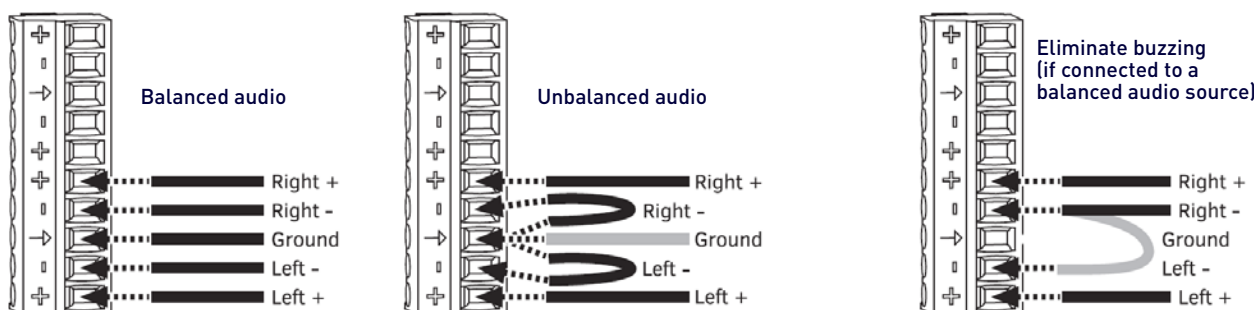

FIG. 80 Dante Audio Switching Boards - orientation and connectors

4. **Enova DGX 800/1600/3200 only** – Attach the HSSI SMA cable (see the next page).
5. Test/check the routing of Audio Switching Boards signals (see page 172).

Options for Wiring ASB Boards to Source and Destination Devices

Source and destination devices will require either balanced (differential) or unbalanced (single-ended) connections. FIG. 81 illustrates options for wiring between sources and input connectors and between output connectors and the destinations. More than one option can be used in the same system.

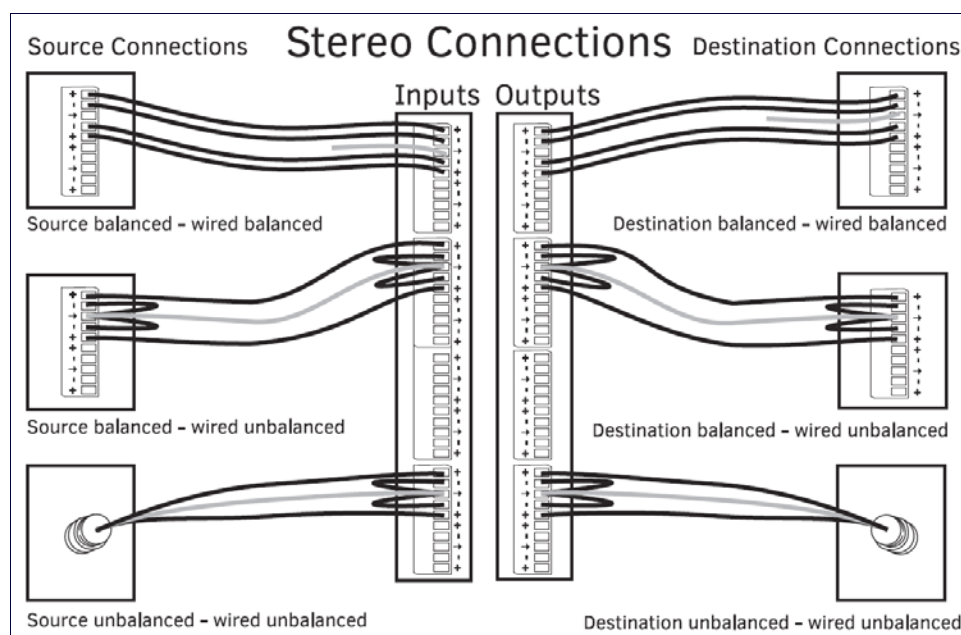

FIG. 81 Wiring from an Audio Switching Board to a variety of source and destination devices

NOTE: To minimize low frequency noise – for stereo audio signals using twisted pair wire, connect the shield (ground) only at one end (recommend receiving end as shown in FIG. 80).

Attaching the HSSI SMA (Sub-miniature version A) Cable

An HSSI (High-Speed Serial Interface) SMA cable (AMX part # 64-0051) is provided when Audio Switching Boards are either purchased separately or with an enclosure. The HSSI cable attaches from the ASB input board to the ASB output board and is required on all enclosure models except the Enova DGX 6400. Do not dispose of or break this cable as the Audio Switching Boards will not function without it.

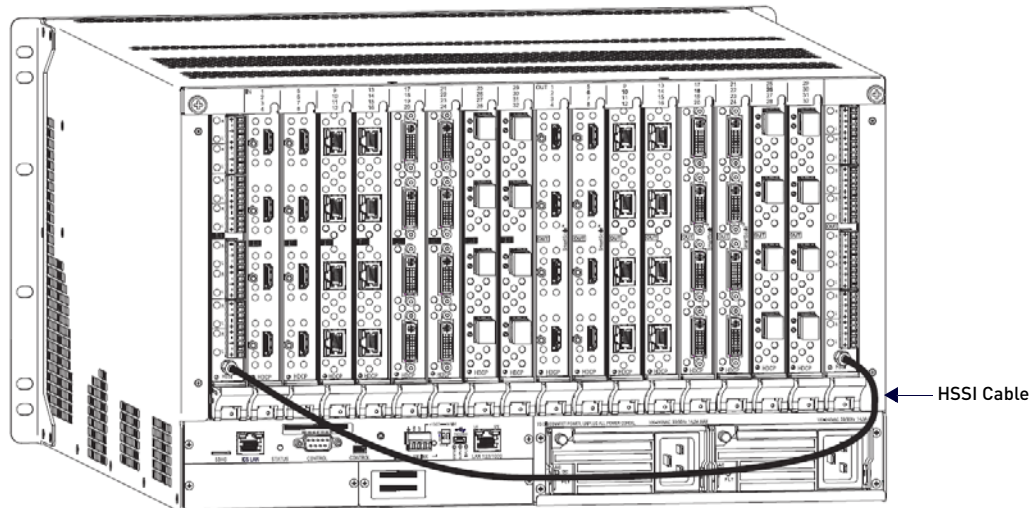

FIG. 82 ASB Audio Switching Boards with HSSI cable connected

NOTE: The command `?EXT_AUD` sent to `5002:1:0` responds with `TRUE` when the cable is attached and the Audio Switching Boards are fully functional.

1. Press and hold the cable connector face flat against the Audio Switching Input Board's HSSI SMA connector face.
2. Using your free hand, push cable connector's coupling nut forward until threads begin to engage between connectors.

IMPORTANT: The cable must not be allowed to rotate while tightening the coupling nut to avoid damage to the center conductor (male pin) on the SMA connector.

3. Rotate coupling nut clockwise until resistance is felt, being careful to avoid cross-threading coupling nut.
4. Attach free-running end of cable to Audio Switching Output Board's HSSI SMA connector per Steps 1-3.
5. Test/check the routing of Audio Switching Board signals (see page 172).

Routing Audio Signals

Audio Routing Capability

The audio routing capability of systems with Audio Switching Boards is system dependent:

Audio Routing Capability - per System	
Enova DGX 800	16x16 audio I/Os comprised of 8 audio only I/Os and 8 video with embedded audio I/Os
Enova DGX 1600	24x24 audio I/Os comprised of 8 audio only I/Os and 16 video with embedded audio I/Os
Enova DGX 3200	40x40 audio I/Os comprised of 8 audio only I/Os and 32 video with embedded audio I/Os
Enova DGX 6400	80x80 audio I/Os comprised of 16 audio only I/Os and 64 video with embedded audio I/Os

System Configuration interface - Audio Virtual Matrix (VM 2)

In the System Configuration interface, the Audio Virtual Matrix (VM 2) is controlled by selecting the **Switch Mode: Audio** button. Virtual Matrix (VM) sizes reflect the model of the enclosure. VM 2 includes audio-only signals and audio embedded on video signals:

System Configuration interface - Audio Virtual Matrix (VM 2)	
Enova DGX 800	8x8 VMs with the exception of VM2 Audio which is 16x16
Enova DGX 1600	16x16 VMs with the exception of VM2 Audio which is 24x24
Enova DGX 3200	32x32 VMs with the exception of VM2 Audio which is 40x40
Enova DGX 6400	64x64 VMs with the exception of VM2 Audio which is 80x80

Audio Matrix I/O Paths

For routing purposes, the audio matrix I/O channels are numbered as follows:

- A/V and Video input and output ranges cover the basic switching size of the system: 8x8, 16x16, 32x32, or 64x64
- Audio only input and output ranges cover the embedded audio as part of the basic switching size of the system, plus the audio available on the Audio Switching Boards (ASB) in the expansion slots, plus the assignment of one input as a down-mixed audio channel, which is routed as a separate input:

Audio Matrix I/O Paths	
Enova DGX 800	1-8 embedded audio, 9-16 audio only, 17 down-mix audio only
Enova DGX 1600	1-16 embedded audio, 17-24 audio only, 25 down-mix audio only
Enova DGX 3200	1-32 embedded audio, 33-40 audio only, 41 down-mix audio only
Enova DGX 6400	1-64 embedded audio, 65-80 audio only, 81 down-mix audio only

For switching audio only via the System Configuration interface, use the Audio Switch Mode (VM 2). When embedded audio is sent as audio only, each signal will be numbered according to the number of the video input or output that contains the embedded audio. Audio on the Audio Switching Boards will be numbered using the numbering scheme of the video input or output number +1, +2, +3, etc. per product according to the table below:

Dante Audio Switching Boards - Routing Numbers			
Product	Board Orientation	Expansion Board Number	Connector/Routing Number
Enova DGX 800	Horizontal	Input 1	Inputs 9-16
		Output 1	Outputs 9-16
Enova DGX 1600	Horizontal	Input 1	Inputs 17-24
		Output 1	Outputs 17-24
Enova DGX 3200	Vertical	Input 1	Inputs 33-40
		Output 1	Outputs 33-40
Enova DGX 6400	Horizontal	Input 1	Inputs 65-72
		Input 2	Inputs 73-80
		Output 1	Outputs 65-72
		Output 2	Outputs 73-80

The input and output numbers in the last column in the table above are the numbers used for routing the Audio Switching Board's audio channels in the Audio Switch Mode.

For example, on an Enova DGX 800: In the System Configuration interface, to route the source wired to the first connector on the Audio Switching Input Board in the first input expansion slot, select the Audio Switch Mode and click Input 9.

In addition, audio embedded on an HDMI video input can be routed as an embedded audio-only signal.

For example, on an Enova DGX 800: In the System Configuration interface, to route an embedded audio-only signal from the source attached to the third connector on the first HDMI Input Board, select the Audio Switch Mode and click Input 3.

Testing/Checking Audio Signal Routing

Input Board – If an embedded audio signal is being replaced on a video output signal, execute a test switch using the video signal. See the *Executing a Test Switch* section on page 70 for details.

Output Board – If audio is being pulled from a video input or output signal and sent to an auxiliary audio-only destination, check the auxiliary or supplemental audio equipment involved to be sure the audio signal is present where expected. If the system does not handle the audio in the expected manner, see "Audio Switching Boards Troubleshooting" on page 174.

Digital Signal Processing (DSP)

Once the system is installed and all devices are in their final locations, the sound can be fine-tuned for optimum performance. To properly adjust the sound, signals need to be routed and volume will need to be adjusted throughout the process.

NOTE: *Before fine-tuning the system for its final location, route a few test switches to verify that the system is working correctly and to determine what type of digital signal processing adjustments are needed.*

Audio Switching Boards allow for digital signal processing (e.g., input gain, volume, equalizer) on every input /output in the enclosure.

All of the types of supported DSP settings (see the table that follows) can be adjusted using the System Configuration interface (see page 137). They can also be adjusted with digital signal processing SEND_COMMANDs (see page 231) or DGX_SHELL commands (see page 273).

NOTE: *The only types of digital signal processing that can occur using the control panel are volume, gain, and mute on the embedded digital audio signals only (see page 255).*

Input and Output Digital Signal Processing

Input and Output Digital Signal Processing	
Digital Signal Processing	Audio Adjustment Parameters
Output Volume	-100 dB to 0 dB (attenuation)
Volume Limiter	Programmable minimum and maximum volume limits
Mute	Mute function on each output path <ul style="list-style-type: none"> When a muted output is un-muted, the output returns to its previously un-muted volume When a volume command is sent to a muted output, the output remains muted; when the output is un-muted, the volume returns at the new level
Input Gain	-24 dB to +24 dB <ul style="list-style-type: none"> Allows source signals of varying amplitudes to be equalized Inputs are set to unity gain at the factory <p>Note: Make input gain adjustments before fine tuning the outputs.</p>
EQ Gain	-12 dB to +12 dB
Compression (Enable/Disable)	Audio inputs (when enabled) can be independently configured for the following settings: <ul style="list-style-type: none"> Attack from 1 to 2000 milliseconds Release from 10 to 5000 milliseconds Threshold of -60 dB to +0 dB Ratio 1 to 20
Delay	0 to 200 milliseconds (each audio signal independently)
10-Band Parametric Equalizer	Selectable center frequency for each band independently <ul style="list-style-type: none"> Used to boost or cut the frequencies for each output Each equalization band spans one octave and is identified by its center frequency Bands are set for a flat response (0 dB) at the factory
Preset Filter Types	Available preset filter types (apply to each band independently): Bell, Bass shelf, Treble shelf, Low pass, High pass, Band pass, Band stop,
Band Gain	-12 dB to +12 dB
Band Q	0.1 to 20
Tone	Available types of tones: Off (default), Voice, Music, Movie Note: The tone adjustment is applied on top of the equalizer adjustments.
Balance	Balance level can be set from -20 to +20, left to right (default value is 0)
Tone Generation (may be switched to one or more audio outputs)	Available test tones: 60 Hz, 250 Hz, 400 Hz, 1 kHz, 3 kHz, 5 kHz, 10 kHz, Pink noise, White noise

NOTE: Configuration data is not affected by firmware upgrades.

Stereo Audio

Audio on Audio Switching Boards can be processed as a stereo audio pair. Stereo audio input channels are paired (left and right) to present the grouped output on both output channels (left and right).

down-mix Audio Input

In sound recording and reproduction, down-mixing is the process by which multiple recorded channels are combined into one or more channels.

In multi-track recording, multiple sound sources are recorded from separate microphones to individualized audio channels. down-mixing is the process of combining those audio channels to produce one or two channels that include all content.

Audio Switching Board down-mix Input

Audio Switching Output Boards provide the ability to down-mix the audio signal from one HDMI input (must be assigned as the down-mix input) to stereo audio. While the sample rate can be any valid rate, the data will be sample rate converted to 48 kHz. The resulting audio can be routed to any or all of the analog or digital audio outputs.

The down-mixed input is fed from a single selectable embedded audio input from any Enova DGX Input Board. down-mixed audio from a single input can be switched to any or all embedded or auxiliary audio outputs.

Supported down-mix Input Formats

- Dolby TrueHD
- Dolby Digital Plus
- Dolby Digital
- DTS-HD Master Audio
- DTS-HD High-Resolution Audio
- DTS
- 2 CH through 8 CH L-PCM

Routing the down-mix Input

The down-mix input is selected from the available audio inputs and is routed the same as any other audio input to any or all outputs (for general switching and configuration instructions, including the down-mix input, see page 130).

down-mix SEND_COMMANDs

The down-mixed audio input uses a subset of the SEND_COMMANDs available for Audio Switching Boards (see below). For details on each of the SEND_COMMANDs that work with the down-mixed audio input, see the Audio Input SEND_COMMAND section on page 231.

- AUDIN_STATUS
- AUDIN_GAIN
- AUDIN_STEREO
- AUDIN_COMPRESSION
- AUDIN_COMPRESSION_ATTACK
- AUDIN_COMPRESSION_RELEASE
- AUDIN_COMPRESSION_RATIO
- AUDIN_COMPRESSION_THRESH

NOTE: *To negate a down-mix command, reroute the switch.*

Audio Switching Board Troubleshooting

If the audio is not present or is not at the expected destination:

- You may need to re-wire to a different connector (see the section on "Audio Routing Capability" on page 171).
- Check to be sure all the "Rules for System Setup" on page 164 have been followed.
- Verify that the Audio Switching Board is seated correctly by removing and re-seating (see page 266) and then test/check the board's functionality again.

If audio signal output format (2 channel L-PCM) is different than the required output format:

- You may route one input to any or all outputs as Dolby TrueHD, Dolby Digital, DTS-HD Master Audio, DTS, or 2 CH through 8 CH L-PCM format by selecting that input as the down-mix Input (see page 130).

- or -

- You may change the output format by disabling the extraction/insertion of the signal by Audio Switching Boards and allow the input signal to be passed through the system as embedded audio on a video signal (see page 143).

If audio buzzes when connected to a balanced audio input device:

- Wire the Audio Switching Board (ASB) connector as follows (see wiring example on the right in FIG. 80 on page 170):

ASB L+ to device L+

ASB R+ to device R+

ASB ground not connected

ASB R- to device R-

Jumper from ASB R- to ASB L-

If down-mixed audio is not present or is intermittent with good video:

- A signal containing both video and audio must have space for both signal portions. The audio signal portion lies in the blanked portion of the video signal. High Bit Rate Audio (HBRA) requires a larger than normal space in the blanked area of the signal. Video formats with reduced blanking normally provide enough space for audio signals. In a signal that combines a video format with reduced blanking and HBRA, the HBRA signal is truncated and can present as either no audio or as problematic audio (static, clicking, absent, etc.). While Enova DGX hardware supports both HBRA and reduced blanking video formats, these formats do not necessarily work with one another.
- To resolve the issue, change either the audio format to non-HBRA or change the video format to a format that does not use reduced blanking.

If the Audio Switching Board defaults to "Embedded" rather than "Switched" audio:

- Audio Switching Boards default to Switched audio but, if the system was upgraded from Enova DGX 8/16/32/64 to 100 Series and then power cycled prior to insertion of ASB boards, the system may not recognize the correct default state.
- To resolve this issue, open the System Configuration interface and toggle the Audio Routing to its correct setting (see page 171).

AIE Audio Insert/Extract Boards

Overview

This chapter pertains to the Enova DGX Audio Insert/Extract (AIE) Board (FG1058-705), which supports analog stereo audio. The Enova DGX Audio Insert/Extract Board works in conjunction with HDMI, 4K HDMI, DVI, DXLink Twisted Pair, DXLink Twisted Pair 4K, and DXLink Fiber Input or Output Boards. The AIE Board can be installed in any of the expansion board slots on the rear of the Enova DGX enclosure. The AIE Board can provide audio insertion and/or extraction functionality for either the input or output boards. The board's DIP switches must be set per the individual system's requirements.

The configuration process requires removing the board from the enclosure and setting its DIP switches (for details, see page 180). By default, the AIE Board is set with the extract/insert function enabled. In addition, the connectors default to "extract" audio.

NOTE: *Setting the DIP switches is the only mechanism for configuring the Audio Insert/Extract Board to either insert or extract audio. Therefore, setting the switches (which requires removal of the board from the enclosure) should be done at the time of installation.*

The Enova DGX 800/1600/3200 holds up to two AIE expansion boards (FIG. 83). The Enova DGX 6400 holds up to eight AIE expansion boards:

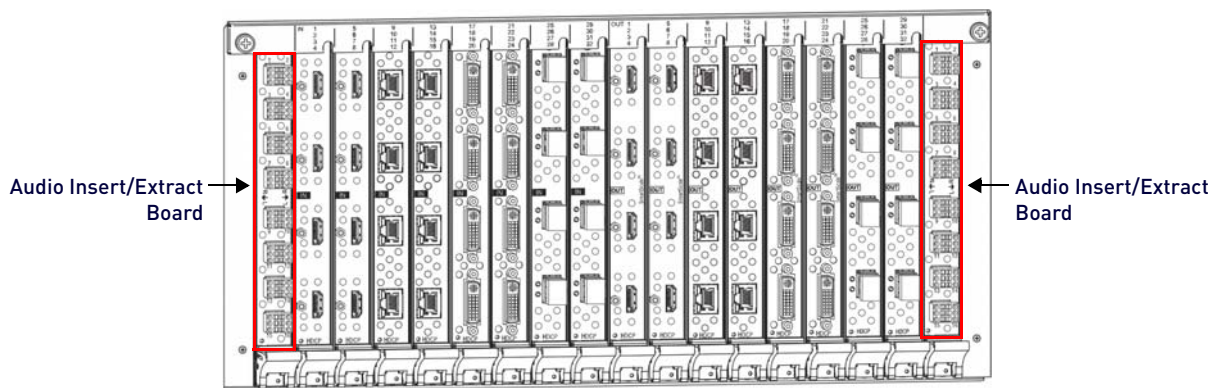

FIG. 83 AIE Audio Insert/Extract Boards installed in Enova DGX 3200 [Expansion Slots]

NOTE: *Enova DGX 800 only: AIE Board connectors 1-8 in the left and right expansion board slots correspond to standard connectors 1-8 on the input and output boards respectively. AIE connectors 9-16 are inoperable.*

Embedded audio signals switch with the video channels. Through the use of the Audio Insert/Extract Board, embedded audio can be extracted and external audio matrix switches can be executed (using a separately purchased audio matrix switcher like the Precis DSP) and then reinserted post-switch on the output side. For complete information on the Audio Insert/Extract Board, see page 183.

Rules for System Setup

- Individual connectors on an AIE Board in either expansion slot can be configured by setting the DIP switches to insert or extract audio (default = "Enable/Extract").
- If an AIE connector is set to "Disable," then it *must* also be set to "Extract."
- When audio is "extracted" from an HDMI signal, the audio signal is not only sent to separate audio equipment but also remains intact as embedded audio on the HDMI signal which is handled by the Enova DGX Switcher.
- When audio is "inserted" onto an HDMI signal, the audio signal replaces the embedded audio on the HDMI signal which is handled by the Enova DGX Switcher.
- Left expansion board slot (Enova DGX 800/1600/3200) and top expansion board slots (Enova DGX 6400) – AIE Board connectors correspond numerically to the standard input connectors. The audio signal on AIE Input 1 is either inserted or extracted onto/from standard Input 1 (2 works with 2, 3 works with 3, etc).

For example, when AIE Input 1 in the left expansion board slot is set to insert and then you route HDMI Input 1, the audio signal for AIE Input 1 is embedded on the HDMI signal.

- Right expansion board slot (Enova DGX 800/1600/3200) and bottom expansion board slots (Enova DGX 6400) – AIE Board connectors correspond numerically to the standard output connectors. The audio signal on AIE Output 1 is either inserted or extracted onto/from standard Output 1 (2 works with 2, 3 works with 3, etc.).
- The audio is always inserted or extracted as analog stereo audio at line level.
- Insert/Extract settings provide unity gain to and from the digital domain.

IMPORTANT: *The AIE Boards do not form an independent switching matrix. When an AIE Board is used on the input side, audio signals cannot be controlled separately, but must either switch with the HDMI as embedded audio (insert function) or are sent to supplemental audio equipment (extract function). When an AIE Board is used on the output side, audio signals have already been switched as embedded audio with HDMI and can be either replaced or extracted, depending on which function is set.*

CAUTION: Audio Switching Boards, Dante Audio Switching Boards, and Audio Insert/Extract Boards are not compatible. Do not install mixed types of expansion boards in the same enclosure. If two types of boards are present, the audio subsystem is disabled.

Enova DGX Model Specific AIE Notes

- **Enova DGX 800 only** – Depending on location, AIE Board connectors 1-8 correspond to standard input or output connectors 1-8. Connectors 9-16 are inoperable.
- **Enova DGX 3200 only** – AIE Boards *will not* work in conjunction with standard input and output connectors 17-32, which are on the boards in the last four input and last four output board slots. Remaining standard board slots should be reserved for input/output boards without audio insert/extract needs.
- **Enova DGX 6400 only** – Numbering overlays are provided for AIE Boards to simplify wiring (see page 181). In the Enova DGX 6400, AIE Boards in the top portion of the enclosure work with input boards that are also located in the top portion of the enclosure. AIE Boards in the bottom portion of the enclosure work with output boards that are also located in the bottom portion of the enclosure.

Enova DGX Audio Insert/Extract Boards - Specifications

Applies to Audio Insert/Extract Board FG1058-705.

Enova DGX Local Analog Audio Specifications	
Audio Insertion	
Audio Signal Type	<ul style="list-style-type: none"> • Enova DGX 800: Analog stereo, up to 8 channels per enclosure • Enova DGX 1600/3200: Analog stereo, up to 16 channels per enclosure • Enova DGX 6400: Analog stereo, up to 64 channels per enclosure
Analog Input Level (max.)	+3 dBu, unbalanced
Input Impedance	10 kohms
Analog to Digital Conversion	48 kHz sample rate, 24-bit
Analog to Digital Reference Level	+3 dBu = 0 dBfs
Optimal Analog Audio Operating Range	-30 dBu to +2 dBu
Connectors	8 pluggable, dual three-position, terminal blocks each containing two single-ended stereo contacts (supports 28 to 18 AWG)
Audio Extraction	
Audio Signal Type	<ul style="list-style-type: none"> • Enova DGX 800: Analog stereo, up to 8 channels per enclosure • Enova DGX 1600/3200: Analog stereo, up to 16 channels per enclosure • Enova DGX 6400: Analog stereo, up to 64 channels per enclosure
Audio Signal Type Support	Requires 2 CH L-PCM (32, 44.1, 48, 88.2, 96, 176.4, and 192 kHz at bit depths of 16, 20, and 24)
Analog Output Level (max.)	+2.8 dBu, unbalanced, >=5 kohms
Output Frequency Response	<+/-0.3 dB, 20 Hz to 20 kHz
Audio Output THD+N	<0.04%, 1 kHz, -10 dBu to +2.8 dBu
Audio Output SNR	>95 dB, 20 Hz to 20 kHz, Vin = +3 dBu
Digital to Analog Resolution	24 bit, 2 Channel (stereo audio)
Digital to Analog Reference Level	0 dBfs = +3 dBu
Optimal Digital Audio Operating Range	-30 dBfs to -2 dBfs
Audio Synchronization	Progressive and interlaced video formats @ 60 Hz frame rate: Audio is actively delayed to match video within 6.7 ms leading up to 9.3 ms lagging
Connector	8 pluggable, dual three-position, terminal blocks each containing two single-ended stereo contacts (supports 28 to 18 AWG)

NOTE: Only 2 channel L-PCM audio is supported from the AIE extraction port. Multi-channel (>2 channel) L-PCM formats will pass incomplete audio if extracted (only 2 of the multiple channels will be extracted). All other audio formats will be muted at the extraction port.

System Examples

The examples below show some uses for the insertion/extraction functionality on the AIE Board. Individual connectors on an AIE Board can be set to insert or extract audio onto/from their numerically corresponding standard inputs/outputs.

NOTE: The Enova DGX 6400 enclosure's AIE Boards are located top and bottom on the rear. Therefore, this section's references to left and right expansion board slots correspond to the top and bottom expansion board slots respectively on the Enova DGX 6400.

AIE Board in Left Expansion Board Slot - Extract Function

Extracted audio remains intact from standard input to standard output but is also sent on to an auxiliary audio system for further distribution (FIG. 84):

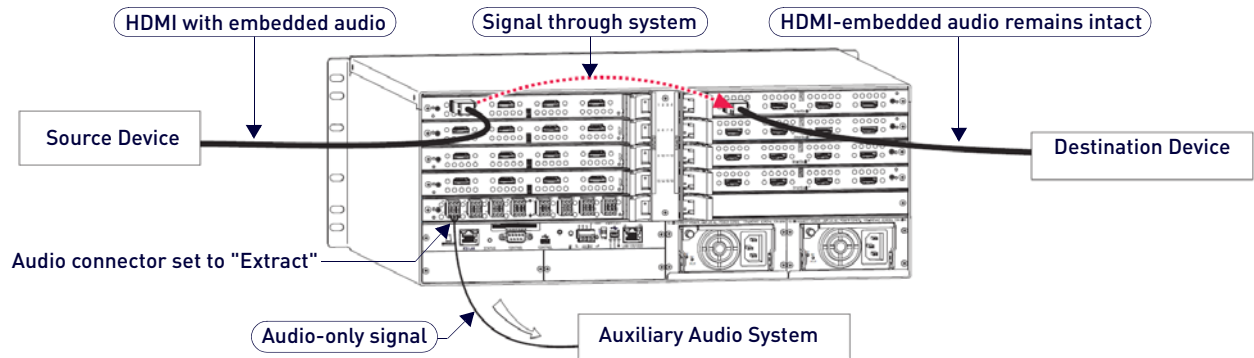

FIG. 84 Audio extracted from HDMI input signal and sent to auxiliary audio system

AIE Board in Left Expansion Board Slot - Insert Function

Inserted audio is received separately from PC source, embedded onto the HDMI signal, and routed from standard input through standard output(s) to destination(s) as an HDMI signal with embedded audio (FIG. 85):

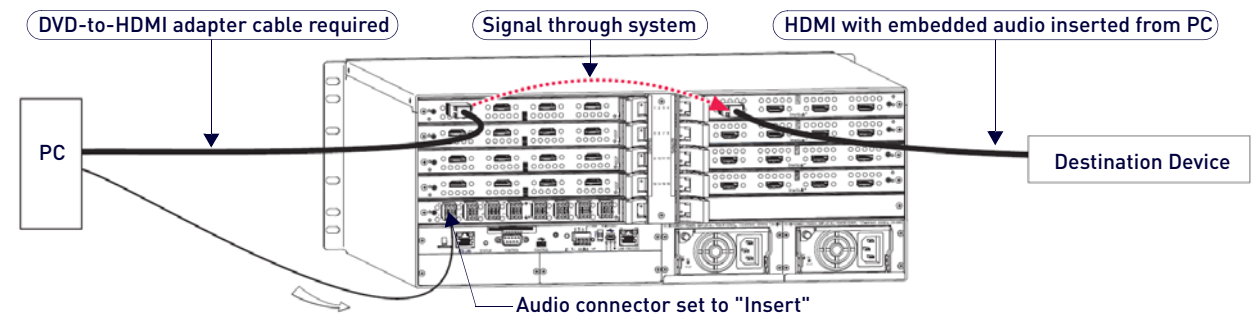

FIG. 85 Audio inserted onto HDMI input signal

AIE Board in Right Expansion Board Slot - Insert Function

Inserted audio from auxiliary audio system replaces embedded audio on HDMI signal and is sent to the destination device (FIG. 86):

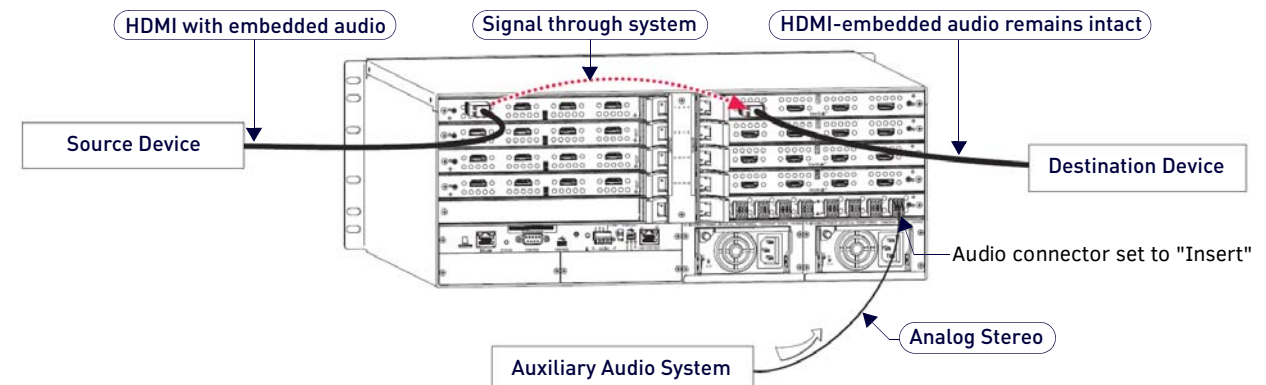

FIG. 86 Audio inserted onto HDMI output signal

AIE Board in Right Expansion Board Slot - Extract Function

Audio is extracted by the AIE Board on the output side for use in supplemental audio equipment as well as remaining intact as HDMI with embedded audio from the output to the destination device (FIG. 87):

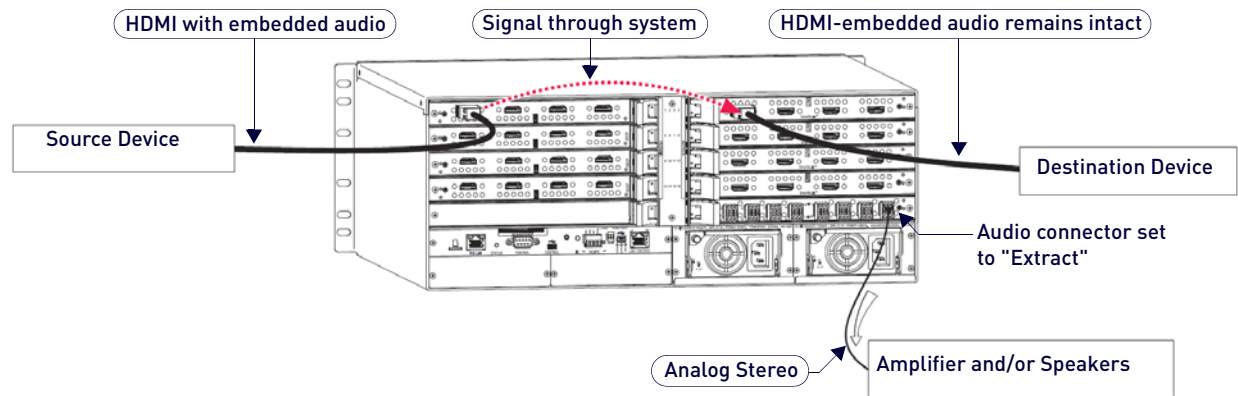

FIG. 87 Audio extracted from HDMI output signal

AIE Boards in Both Expansion Board Slots - Insert and Extract Functions

- On left – embedded audio is extracted from standard input side and is sent on for audio processing.
- On right – inserted audio replaces embedded audio on HDMI signal and is sent to the destination device (FIG. 88):

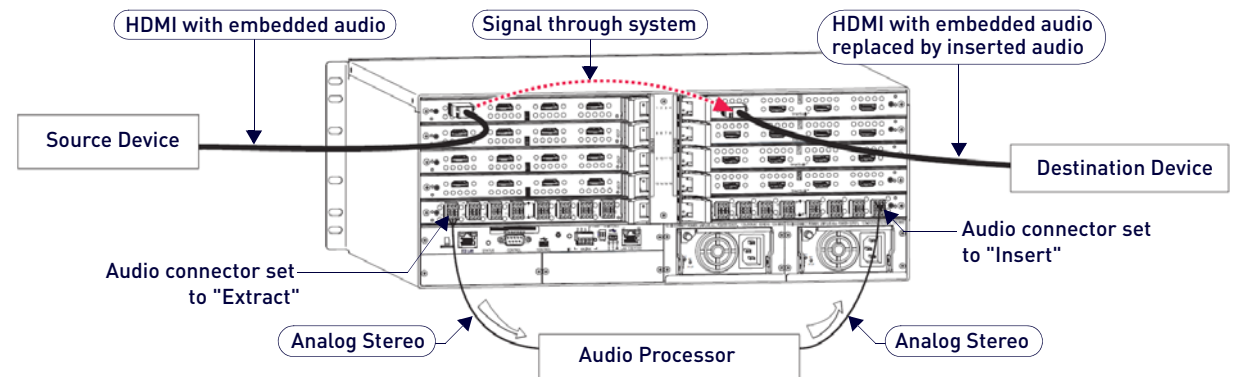

FIG. 88 Audio extracted from HDMI input signal and inserted onto HDMI output signal(s)

- When audio is routed through a separate Audio Matrix Switcher, the audio can be inserted back into the original system on multiple audio insert/extract connectors.
- When audio is "extracted" from an HDMI signal, the audio also remains intact as embedded audio on the HDMI signal.

Setting Audio Connectors to Insert or Extract

Setting AIE functionality to insert or extract audio requires removing the AIE Board, setting the DIP switches, and reinstalling the board.

- If the factory default of enable/extract meets all of the system's needs, this process is not necessary.
- Setting the DIP switches is the only mechanism for configuring the AIE Board's insert/extract functionality. Therefore, setting the switches (which requires removal of the board from the enclosure) needs to be done at the time of installation setup.

Removing an AIE Board

CAUTION: AIE Boards have an EMI (Electromagnetic Interference) gasket along one edge of the faceplate. Handle boards carefully to avoid dislodging or damaging the gasket on the board being handled and the gasket on the adjacent board or blank plate.

NOTE: If an AIE connector is set to "Disable," then it must also be set to "Extract."

1. Power down the enclosure (the AIE board is *not* hot-swappable).
2. **Enova DGX 3200 only** – Loosen the captive screw on each end of the numbering plate above the boards, and set the plate aside (FIG. 89):

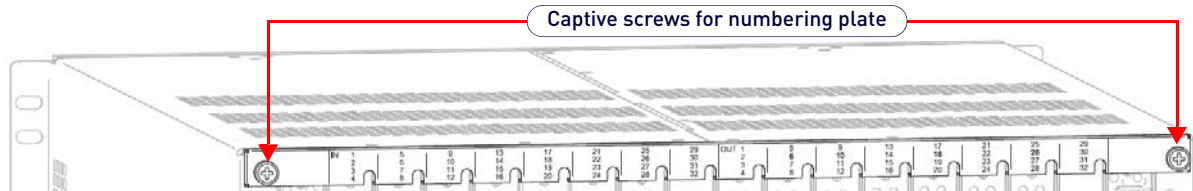

FIG. 89 Enova DGX 3200 only - two captive screws hold numbering plate above boards

3. Remove the pan head screw that holds the AIE Board in place.
4. Push on the board's extractor handle as far as it will go (about a 45° angle). With the handle extended, carefully pull the board straight out of the expansion slot (FIG. 90):

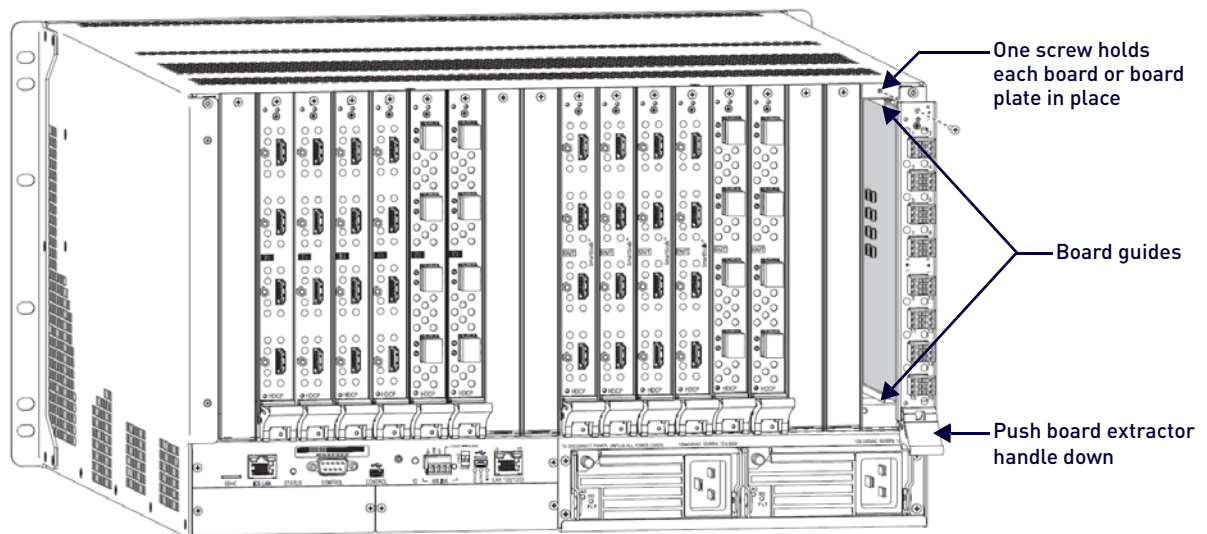

FIG. 90 Remove screw, push board extractor handle down, then pull board straight out (Enova DGX 3200 shown)

5. Set the Dip switches according to the information on the following page, and then reinstall the board according to the directions on page 180.

Setting the DIP Switches

IMPORTANT: When an AIE connector is set to insert audio, audio on the corresponding video signal will always be replaced with the input from the AIE connector. When the AIE connector does not have a valid audio signal to insert, "no signal" is the input that will be inserted – resulting in no sound.

The individual AIE connectors on the AIE Board must have their DIP switches set according to how the audio for each connector is to be used in the system.

Each board has two DIP switches per AIE connector with the corresponding AIE connector number displayed vertically between the switches, labeled "Channel Setting" (FIG. 91):

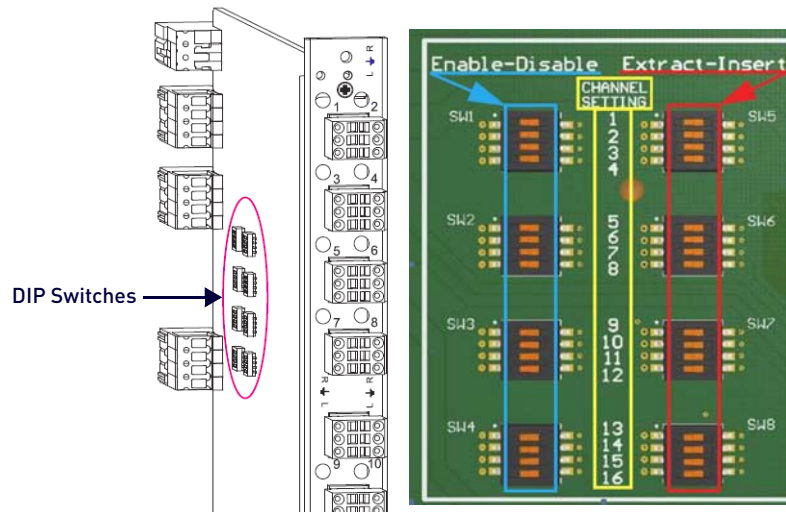

FIG. 91 Flip DIP switches to change settings

The DIP switch on the left is used for enabling or disabling the extract/insert functionality. The DIP switch on the right can be set to either "extract audio from" or "insert audio onto" the signal routed on numerically corresponding standard input or output connectors.

NOTE: Write down the setting for each connector before reinstalling the AIE Board into the Enova DGX enclosure. This will make verifying correct audio switching (see page 182) easier.

IMPORTANT: When disabling extraction/insertion functionality for connectors on the AIE board, use the DIP switch settings "Disable/Extract"; do not use the settings "Disable/Insert."

Enable/Disable DIP Switches

- Located on the left (see blue rectangle in FIG. 91).
- To enable, flip left. Enable must be selected for the insert/extract function to work.
- To disable, flip right. Disable turns off the insert/extract function for that port.

Extract/Insert DIP Switches

- Located on the right (see red rectangle in FIG. 91).
- To extract audio, flip left. The AIE connector will pull the embedded audio signal off the corresponding standard input or output connector's signal (the embedded audio remains intact on the HDMI signal).
- To insert audio, flip right. The AIE connector will insert the connected audio signal onto the corresponding standard input or output connector's signal.

NOTE: When shipped from the factory, the DIP switches are set to "Enable" and "Extract."

Reinstalling an AIE Board

CAUTION: AIE Boards have an EMI (Electromagnetic Interference) gasket along one edge of the faceplate. Handle boards carefully to avoid dislodging or damaging the gasket on the board being handled and the gasket on the adjacent board or blank plate.

CAUTION: Do not try to install an AIE Board in any of the standard input or output board slots. (Standard board slots are indicated by the numbers on the numbering plate that is above the slots on an Enova DGX 3200 and between the input and output slots on an Enova DGX 800/1600/6400.) An AIE Board can only be installed in an I/O expansion board slot.

1. **Enova DGX 3200** – With the board's extractor handle in the extended (unlocked) position, line up the board's edges on the board guides that are along the top and bottom of the expansion slot.
- or -

Enova DGX 800/1600 /6400 – With the board's extractor handle in the extended (unlocked) position, line up the board's edges on the board guides that are along the left and right of the expansion slot. Note that boards on the input side have guides at the top of the slot and that guides for boards on the output side are at the bottom of the slot due to their reversed orientation in the enclosure.

2. Begin pushing the AIE Board into the expansion slot until the extractor handle starts to engage the metal extractor plate (the extractor handle moves into its folded position). When the extractor handle starts to lift, flip the handle toward the center of the board until it snaps into its folded (locked) position, which firmly seats the board.
3. Insert and tighten the screw (removed previously) that holds the board in place.
4. **Enova DGX 3200 only** – When wiring is complete and functionality is checked, replace the connector numbering plate that was removed previously.
5. Re-apply power to the enclosure.

IMPORTANT: *If for any reason an I/O expansion board slot is left empty, be sure to attach a blank plate to cover the empty slot prior to re-applying power to the enclosure.*

Enova DGX 6400 Only - AIE Board Numbering Overlays

The Enova DGX 6400 can hold up to eight AIE Boards (four on the upper rear of the enclosure and four on the lower rear). The AIE Boards in the upper slots work in conjunction with the Input Boards; the AIE Boards in the lower slots work in conjunction with the Output Boards.

Because all AIE boards are numbered 1 through 16, overlays are provided to simplify AIE connector wiring on the Enova DGX 6400. The overlays provided include: two each for the faceplates for connectors 1-16, 17-32, 33-48, and 49-64. The numbers on the overlays (when installed per the instructions below) directly correlate to the input and output connectors.

IMPORTANT: *The orientation of the AIE Boards in the right expansion board slots places the lowest connector number for these boards on the far right (e.g., the overlay for the board in the top right slot will read left-to-right as 48 though 33).*

NOTE: *The audio connectors will need to be removed before applying the overlays.*

Applying Overlays to AIE Board Faceplates

1. Check the numbering on the overlay to determine which board it applies to (see FIG. 93 on page 182).
2. Peel the backing off the overlay and discard the backing.

NOTE: *For Step 3, start at the screw end and work across to the extractor handle end.*
3. Align the overlay carefully on the AIE Board's faceplate and then press firmly on the overlay to set the adhesive on the faceplate.
4. Repeat Steps 1 through 3 as necessary for the remaining overlays (FIG. 92):

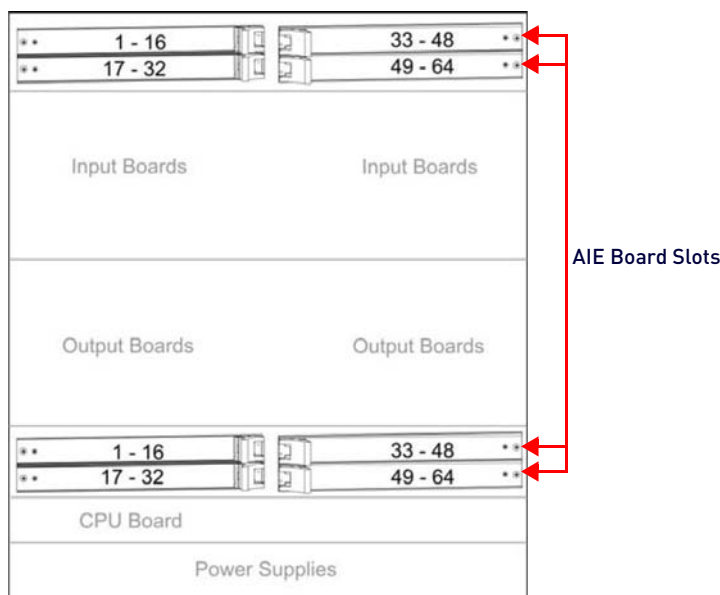

FIG. 92 AIE Board slot numbering on Enova DGX 6400

Attaching Wires

When attaching audio wires, you may find it easier to unplug the audio connectors before you start. For connector details, see Audio Specifications on page 176.

Wiring AIE Boards

Audio boards and connectors are positioned vertically on the Enova DGX 3200 and horizontally on the Enova DGX 800/1600/6400. Be sure to note the labeling for the wiring on the "R" (right channel) and the "L" (left channel) wires.

NOTE: *Enova DGX 800/1600/6400 only – the orientation of Audio Insert/Extract Board in the right expansion slot places the number 1 audio connector on the far right of the board.*

CAUTION: *Connecting AIE output left and Right channels to the same point to obtain a single channel may damage the AIE Board.*

NOTE: If wiring the audio connectors to balanced audio input devices, see page 183 for options.

Wiring Audio Connectors

1. Press a very small tip screwdriver (or a T-pin) into the square hole to release the tension clamp.
2. Insert the wire into the round hole.
3. Remove the screwdriver from the square hole so that the clamp places tension on the wire (FIG. 93):

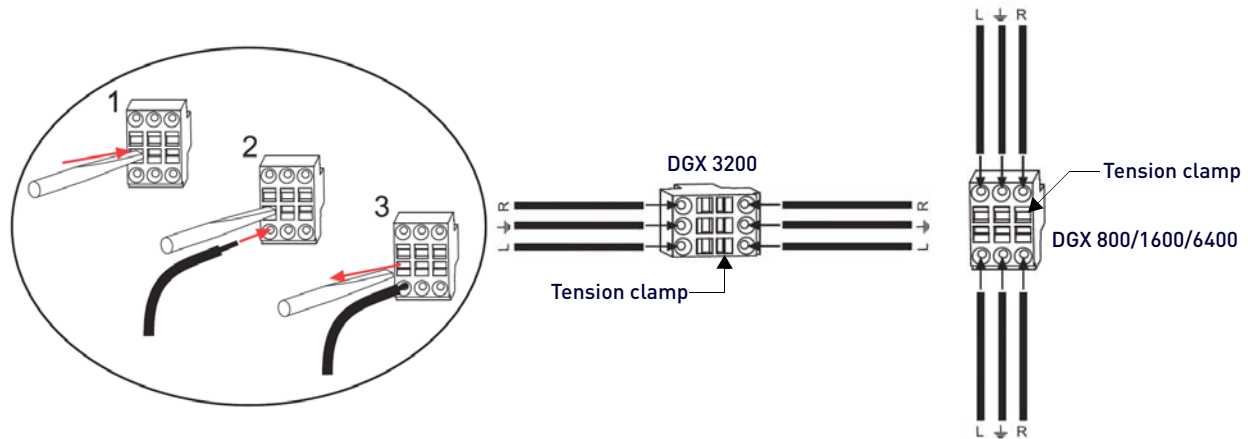

FIG. 93 Audio wiring for AIE Board

NOTE: Insert a T-pin in each of the 3 tension clamps on one side before inserting wires.

4. Test/check the Insert/Extract functionality (see below).

Testing/Checking the Insert/Extract Functionality

Insertion – If the DIP switch setting results in being inserted onto the corresponding video input or output signal, execute a test switch using the video signal. See the *Executing a Test Switch* section on page 70 for details.

Extraction – If the DIP switch setting results in audio being extracted from a video input or output signal, check the auxiliary or supplemental audio equipment involved to be sure the audio signal is present where expected.

If the system does not handle the audio in the expected manner, see "AIE Board Troubleshooting" on page 182.

AIE Board Troubleshooting

Problem - Audio is not present or is not at expected destination device.

Possible Solution #1 - Re-wire to a different connector:

- To verify input and/or output connection, check the connector numbers on the AIE Boards. The AIE connector numbers correspond directly to the numbers for the standard input or output connectors that they insert audio into or extract audio from. AIE 1 works with standard Input 1, AIE 2 works with standard Input 2, etc.
- Enova DGX 800 only - Depending on location, AIE Board connectors 1-8 correspond to standard input or output connectors 1-8. Connectors 9-16 are inoperable.
- Enova DGX 3200 only - Remember that the AIE Boards *will not* work with connectors 17-32, which are on the boards in the last four input and last four output board slots.

Possible Solution #2 - Re-install board:

- Verify that the AIE Board is seated correctly by repeating the re-installation procedure.
- Test/check the insert/extract functionality again.

Problem – Connecting to balanced audio input device results in extracted audio buzzing.

Solution – Re-wire audio connections:

- Wire the AIE connector as follows: AIE L to device L+; AIE R to device R+; AIE ground to device R-; and a jumper from device R- to device L- (see FIG. 94 below).

Problem – AIE extracted audio from an HDMI output drops out over time. Probably due to upstream unstable/garbage video introduced onto the HDMI output port with no sink connected.

Solution – Connect a sink to the HDMI output port:

- Verify the cause by sending the DGX_SHELL commands: `power OFF EXPOUT` followed by `power ON EXPOUT`. If the audio signal recovers, not having a sink connected to the HDMI output port was likely the cause.
- Connect a sink with a valid EDID to the open HDMI output port. The sink can be something like an EDID emulator or a monitor. Optionally, you can loop back the HDMI output port to an unused HDMI input port.

The problem is resolved when the audio no longer drops out.

Options for Wiring AIE to Balanced Audio Input Device

CAUTION: Connecting AIE output left and Right channels to the same point to obtain a single channel may damage the AIE Board.

Standard Wiring

FIG. 94 indicates the standard way to wire an AIE connector to a balanced audio input device:

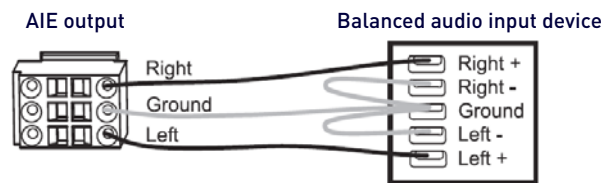

FIG. 94 Standard wiring from AIE to balanced audio input device

If Necessary – Wiring to Eliminate Buzzing

The wiring in FIG. 95 can be used if the extracted audio buzzes when connected to a balanced audio input device:

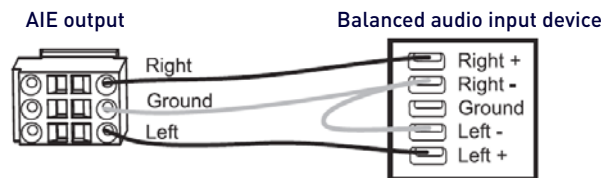

FIG. 95 Wiring from AIE to balanced audio input device if buzzing occurs

System Configuration Interface

Overview

The System Configuration Interface is an on-board web configuration tool containing a set of web pages that can be used during setup to manage your system's network, security, and system needs, as well as configure its inputs and outputs while executing switches.

This chapter covers the interface's Enova DGX Switcher Configuration pages: *Switching*, *Configuration*, and *Status*. These three pages are accessed from the Switcher drop-down list on the main menu bar of the System Configuration interface. The remaining menu options are covered in the *Web Console & Programming Guide* at www.amx.com (located on the product pages for Enova DGX 100 Series Switchers).

The examples provided assume an Enova DGX 100 Series Switcher is connected to a LAN via its LAN 100/1000 port (see page 70) and that the System Configuration interface has been accessed (see page 74).

As of NX Series (x200) Master firmware version 1.6.150, the Enova DGX 100 Series Switchers introduce support for pre-qualification of switches to prevent switching signals of higher band-width than the downstream portions of the system are capable of supporting. See Legend Page section to understand the ways in which Pre-Qualification feature indicates pre-qualification mismatches via the System Configuration Interface.

Accessing the System Configuration Interface

To access the interface after initial setup, simply type the integrated Master's IP address in the address bar of the browser and press the Enter key (FIG. 96):

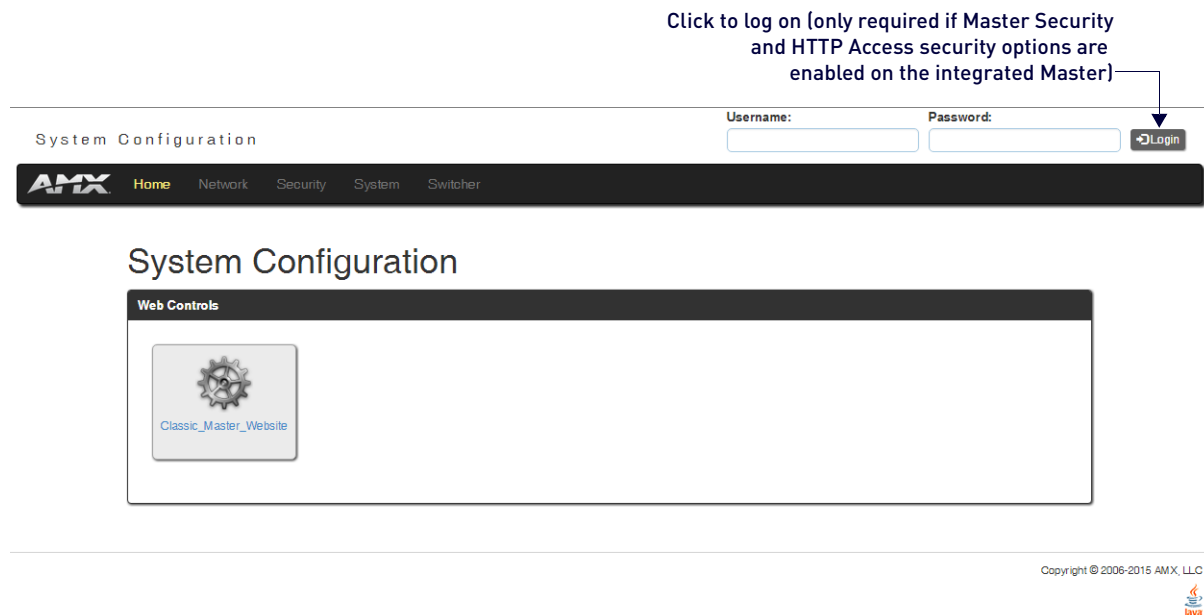

FIG. 96 System Configuration Home page

NOTE: The IP address is available through the Control Panel's LCD menu: *Function/Setup Options/Master Info/IP Address*.

Username and Password

The Username and Password fields at the top right of the interface allow Users and Administrators to access system security functions. The default Username for the interface is "administrator" and the default Password is "password." After initial setup, defaults should be changed to ensure system security.

System Configuration Interface Tips

- For optimal display of interface features use an HTML5 browser (such as Google Chrome).
- Use the most current version of browser software available.
- Some devices run on a secured file-system. As such, file-system operations (e.g., Load and Save operations) may not be supported by the device's default capabilities and may require downloading a file manager application.
- When selecting Inputs and Outputs for switches – you may select an input followed by multiple outputs, but only one input is selectable if you select an output first.
- Inputs and Outputs can only have one name each, regardless of whether the name is set via the Video tab or the Audio tab in the Configuration page (or via NetLinX SEND_COMMANDs VIDIN_NAME, VIDOUT_NAME, AUDIN_NAME, AUDOUT_NAME).

- Information represented in the System Configuration interface is provided through both synchronous and asynchronous communication. The interface should be refreshed after making changes to the system, if the interface session has been open but unchanged for over an hour, or at any point information does not appear to be correct.

Menu Bar

The menu bar at the top of the UI contains the following menu items:

Home	Access the Web Controls options page
Network	Access the IPv4 Setup, IPv6 Setup, and Date/Time pages
Security	Access the General, Users, Groups, and LDAP pages
System	Access the Info and Devices pages
Modules	Access the Device Options, Bindings, User-Defined Devices, and Active Devices pages
Switcher	Access the (Enova DGX Switcher Configuration) Switching, Configuration, and Status pages

Home Page

The Home page provides options for Web Control (e.g., RMS Config, Virtual keypad, Modero Touch Panel, and Classic Master Website).

From the main menu's **Switcher** drop-down list, you can access the *Switching*, *Configuration*, and *Status* pages whose functionality is described in the remainder of this chapter, which applies to all current Enova DGX 100 Series Switchers (all contain integrated NetLinX NX Masters).

Switching Page

The Switching page is used to route the system's inputs to its outputs during system setup.

Each input and output can be labeled by filling in the Input Name or Output Name field on the Configuration page.

NOTE: *The one exception to this statement is the audio input "down-mix" button, which cannot be renamed.*

The number of available video and audio inputs and outputs depends on the Enova DGX 100 Series model and the number and type of boards it contains.

Switching Page Components

The Switching Page Components are described below (FIG. 97):

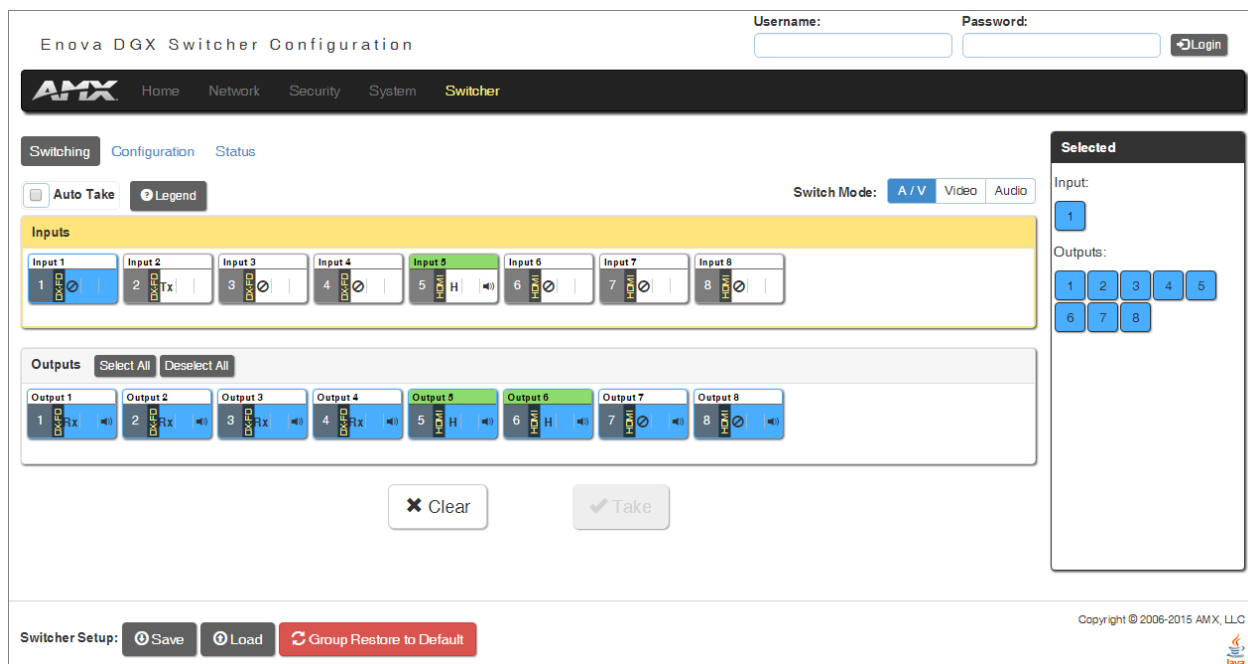

FIG. 97 Switching page

Switching Page Components	
Auto Take button (deselected by default)	When checked, this button persists the Auto Take function and remains illuminated until unchecked. Once an input or output is selected, a click on an output for the input or on an input for an output will execute a switch. This allows for quick cycling through several inputs for a selected output. Note that when a button is selected, it also appears in the Configuration page with signal details (for button/signal details, click the Legend button).
Legend button	Click to open an additional browser tab (Audio/Video Legend) which displays the legend key with details regarding the state of the input (source) and output (destination) connections (FIG. 98). The browser tab opens in a tearaway tab/window that can be dragged and dropped as a standalone desktop window for side-by-side reference with the Switcher/Configuration pages.
Switch Mode buttons	Click the A/V (default), Video, or Audio button to select the type of signal to be switched. These buttons correspond to the available video and audio Virtual Matrices (VMs) in the system. <ul style="list-style-type: none"> Switch Mode buttons are only accessible with Audio Switching Boards (ASB or ASB-DAN) in the enclosure. See the <i>Switch Mode</i> section on page 188 for details.
Inputs section	This section contains buttons for each of the available input signals (per selected Switch Mode) in the system. Click the input button that needs to be switched. Scroll bars on the right-hand side provide access to any inputs on large systems which are not currently visible.
down-mix button	The Audio Switch Mode must be selected before the down-mix button displays. <ul style="list-style-type: none"> The input source used for the down-mix signal is selected on the Configuration page. For information on the down-mix function, see page 181.
Outputs section	This section contains buttons for each of the available output signals in the system. Click the output button(s) that needs to receive the signal from the currently selected input button. Note that when the currently selected button is an output, it also appears in the Configuration page with signal details (for button/signal details, click the Legend button). Scroll bars on the right-hand side provide access to any outputs on large systems which are not currently visible.
Select All / Deselect All buttons	These buttons appear only after an input is selected. Click as necessary to select or deselect all output buttons.
Clear button	Click to de-select all inputs and outputs (if selected, the Auto Take button state persists) and clear routing status in the Configuration pane. Note that the Clear button <i>does not</i> disconnect switches. After the Clear button is selected and the input or one of the outputs already routed is selected, the buttons turn blue to indicate current status. Selecting an output will show status for the input routed to it, not the other outputs also routed from the same input.
Take button	Click to execute the switch for the selected input and output(s). After the switch is made, the current content in the Switching and Configuration pages persists until further action is taken. Note that the Take button is grayed out until one input and one or more outputs have been selected for routing; once these conditions are met, the Take button becomes active. After the Take button is clicked, all of the buttons clear their status.
Selected status bar (non-editable)	This status bar provides quick visual confirmation of input and output selections and their status (blue = currently routed; yellow = ready to route, waiting further action; blue outline = currently routed, but deselected in preparation to disconnect).
Switcher Setup button options	Switcher Setup button options are available on both the Switching page and the Configuration page.
Save and Load buttons – after a system has been set up per the installation's requirements, the configuration values for the entire switcher's state (i.e., system settings and routing, video and audio settings, channel names, custom EDIDs, etc.) can be saved and reloaded at any time. The file is saved as a managed content (non-editable) .xdg file with XML and bin data. This file may be reloaded onto the system it was saved from or loaded onto an identical system or backup system.	
Save button	To save a configuration, click the Save button (when the Save button is clicked, there is no direct indication that the file is being saved). The CPU begins collecting all of the available system data (may take > 2 minutes) and then packages the file for download. Depending on the browser used in the process, the download may either appear with a Save As dialog box or be saved directly into your Downloads folder. The default file name is "defaultYYYY-MM-DD.xdg."
Load button	To load a configuration, click the Load button. A Warning appears indicating that the action will override all of the current configuration values and reboot the switcher. Click Yes and select the saved configuration (.xdg) file from the dialog box. Click Open to begin the file upload. The file take approximately 30 seconds to load then performs a full system reboot (which takes 3-5 minutes, depending on enclosure size).
Note: While a configuration can be saved at any time, loading a configuration requires the majority of the available system resources, without which portions of the load may fail. For this reason, we recommend disabling code and active switches when loading a configuration. Also, a file should only be loaded onto a system that matches the configuration of the saved file. If the system receiving the file does not match the original system, incongruous information (e.g., a DXLink Fiber Input Board is present when the configuration file tries to load HDMI Input Board information) will be skipped.	
Group Restore to Default button	Click to open the <i>Warning</i> dialog (FIG. 99), which requires you to select an A/V Group and an I/O Group to restore to their factory default settings.

Color-Coded Switch Selection and Switching Orientation

Yellow buttons indicate they have been selected but not switched; blue buttons indicate an already routed switch.

NOTE: When disconnecting switches, selecting an input or an output in an already routed switch will turn the button from blue to white, but will leave a thin blue line around the button to indicate it is still active until Take is pressed.

From a cleared state, switching is accomplished from either an input-orientation or an output-orientation depending on whether an input or an output is selected first.

When an input is selected first, the Inputs title bar turns yellow (see FIG. 97 on page 185) and "input-orientation switching" is enabled. Multiple outputs can then be selected for the input followed by Take to execute the switch(es).

When an output is selected first, the Outputs title bar turns yellow and "output-orientation switching" is enabled. A single input can then be selected for the output followed by Take to execute the switch.

NOTE: Pressing Clear before pressing Take allows you to start over.

NOTE: The default selection (input button highlighted blue) for the Switching pane is Input 1, which also appears in the Input section of the vertical "Selected" bar to the right. All output buttons that the default selection is routed to are highlighted and also appear in the Outputs section of the Selected bar.

Legend Page

The Legend page displays the legend key with details regarding the state of the input (source) and output (destination) connections (FIG. 98).

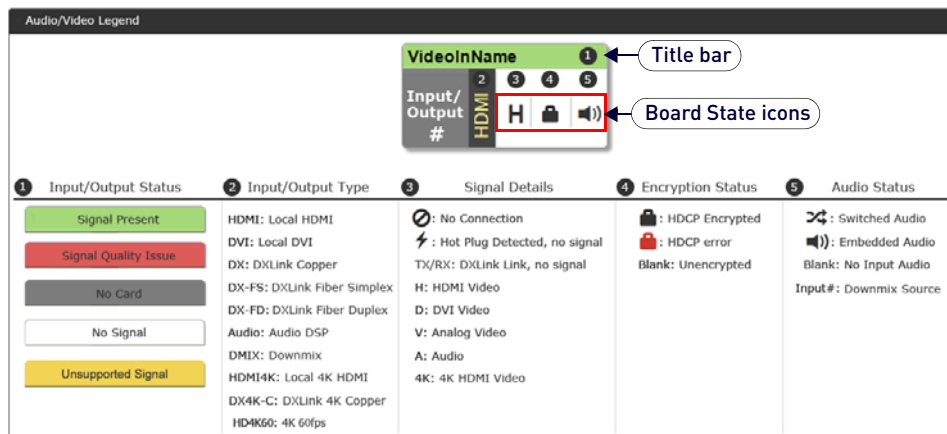

FIG. 98 Legend page

- Unsupported Signal** (amber) on a routed path indicates that the Pre-Qualification system has determined that for the current input video format or DRM/HDCP requirement, all of the hardware components in the path to a specific output do not support its video tier. The Pre-Qualification system blocks the input from being sent to that output. The video tiers are as follows:
 - 1.2k – video formats up to HDMI 1.3a
 - 2.4k30 – 4k video formats that can be passed with HDMI 1.4 (up to HDCP 1.4 and HDCP 2.2 non-Premium)
 - 3.4k60 – 4k video formats that require HDMI 2.0 (up to HDCP 1.4 and HDCP 2.2 Premium or non-Premium)

NOTE: This evaluation does *not* include 3rd party sink capabilities based on EDID data.

NOTE: The *Unsupported Signal* status will only show if a signal is routed *and* a sink is present on the output.
- The 4K icon indicates video images higher than 2048 pixels wide. In some cases, certain 3D video formats (e.g., side-by-side) will indicate they are 4K formats.
- If the enclosure does not include a full set of input/output boards, input and output buttons for connectors that are not available display with a gray Title bar (i.e., No Card).
- The label on the title bar can be edited in the Input or Output Name field on the Configuration page .

Group Restore to Default - Warning dialog

Click the **Group Restore to Default** button to open the Warning dialog, which requires you to select an A/V Group and an I/O Group to restore to their factory default settings (FIG. 99):

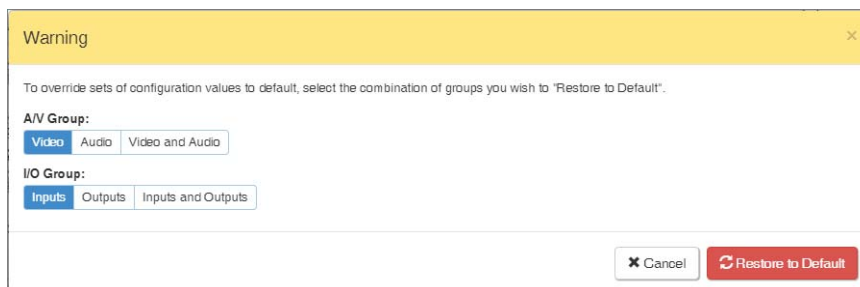

FIG. 99 Group Restore to Default - Warning dialog

NOTE: Group Restore Default applies to *all* of the channels of the selected groups, e.g. the selection options of AV Group Video and I/O Group Inputs will restore all the video options of all inputs to their default setting. If you wish to only restore a single channel and/or a sub-set of channel, you should use the Restore to Default button on the channel's Configuration Page.

Switch Mode

The Switch Mode buttons allow you to choose between switching Audio follow Video (A/V), Video (with embedded audio), or Audio only.

IMPORTANT: Support for the Audio Switch Mode (VM 2) requires Audio Switching Boards in the enclosure.

- A/V and Video input and output ranges cover the basic switching size of the system: 8x8, 16x16, 32x32, or 64x64
- Audio only input and output ranges cover the embedded audio as part of the basic switching size of the system, plus the audio available on the Audio Switching Boards (ASB and ASB-DAN) in the expansion slots, plus the assignment of one input as a down-mixed audio channel:

Enova DGX 800: 1-8 embedded audio, 9-16 audio only, 17 down-mix audio only

Enova DGX 1600: 1-16 embedded audio, 17-24 audio only, 25 down-mix audio only

Enova DGX 3200: 1-32 embedded audio, 33-40 audio only, 41 down-mix audio only

Enova DGX 6400: 1-64 embedded audio, 65-80 audio only, 81 down-mix audio only

Executing a Switch

To execute a switch, click the **Switch Mode** button (otherwise the switch will default to A/V), an **Input** button, an **Output** button(s), and the **Take** button. This is input-oriented switching (also known as one-to-many switching).

NOTE: If you select an output button first (output-oriented switching, which can only be one-to-one switching), you must select an input button next followed by the Take button, i.e., you cannot select additional outputs before you select the input. If you select an output button first and then the input button, the only way to select multiple outputs is to click the Clear button and click the input button followed by the output buttons.

- To **deselect** (clear status) an input button that has already been selected, click another input button *or* click Clear.
- To **deselect** (clear status) a single output button that has already been selected (before an input button), click another output button *or* Click Clear.
- To **clear status** of an input and any or all output buttons, click Clear.
- To **disconnect** all currently selected outputs for an input, click the Deselect All button followed by clicking Take.
- To **execute** a switch with a down-mixed signal the Audio Switch Mode must be selected and the input used for the down-mix signal must be selected on the Configuration page. Click the down-mix button, click the output(s), and click Take.

NOTE: Audio Switching Boards must be present for this functionality to work.

Configuring/Switching the Down-mix Signal

When the system contains Audio Switching Boards (ASB or ASB-DAN), *one* embedded audio signal can be down-mixed and routed at any given time.

NOTE: Signal must be Dolby Digital, Dolby TrueHD, DTS, DTS-HD Master Audio, or 2 CH through 8 CH L-PCM.

When Audio Switch Mode is selected, the "down-mix" input automatically displays as the last analog audio input+1. The down-mix Input number for each of the Enova 100 Series models is shown in the following table.

Down-mix Input #	
Enova DGX 800	17
Enova DGX 1600	25
Enova DGX 3200	41
Enova DGX 6400	81

NOTE: The table above also applies to Enova 8/16/32/64 enclosures that have been upgraded with an Enova DGX 100 Series CPU and that contain Audio Switching Boards (ASB and ASB-DAN).

To designate the source to be routed on the down-mix Input, (in the Configuration page) click the down-mix button in the Switching pane on the left and select the input from the down-mix Source drop-down list in the Configuration pane on the right (FIG. 100):

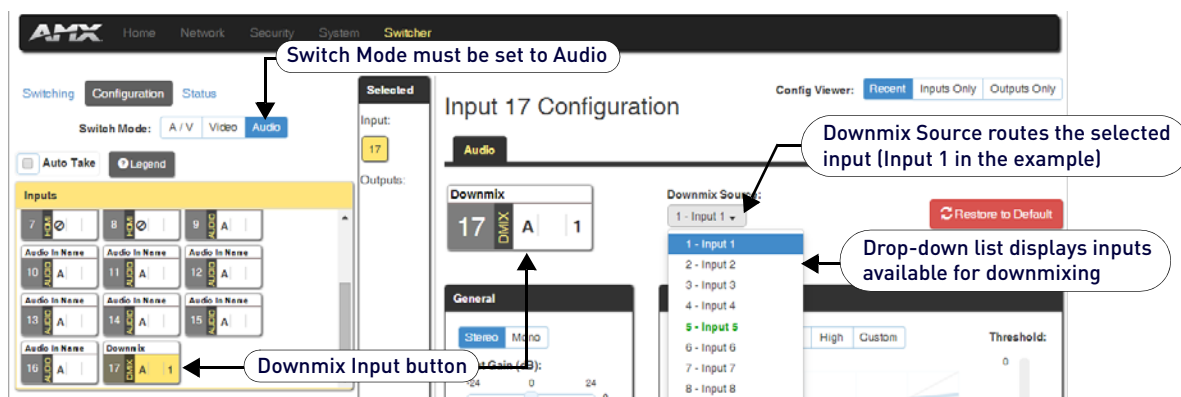

FIG. 100 Down-mix Input Ready To Switch or Configure

Designating an Input for Down-mixing (Configuration page)

1. In the Switching pane on the left, select **Audio Switch Mode**. The down-mix button displays at the end of the input buttons.
2. Select the **down-mix** button.
3. In the Configuration pane on the right, select the input from the down-mix Source drop-down list. The down-mix signal is ready to apply any of the configuration options or to execute switches.
4. To use a different input source for down-mixing, repeat Steps 1-3.

NOTE: Only one input can be down-mixed at a time.

Configuration Page

The Configuration page is used to configure inputs and outputs in the system. The most recently selected input or output displays in the Configuration page in accordance with the currently selected Config Viewer button (Recent, Inputs Only, or Outputs Only). The Configuration page displays the Switching page components compressed on the left.

Any changes made in the Configuration page occur instantaneously on the attached devices. In addition, when you select an input or an output on the left, the options on the right side of the page change to reflect the current settings. Configuration is not affected by power loss, restarting the enclosure, or upgrading the firmware.

Note that the components are active, i.e., they can be used for all switching functionality without needing to return to the full Switching page (FIG. 101):

NOTE: The number of available video and audio inputs and outputs depends on the Enova DGX 100 Series model and the number and type of boards it contains.

Configuration Page Components

The Configuration Page Components are described below (FIG. 101):

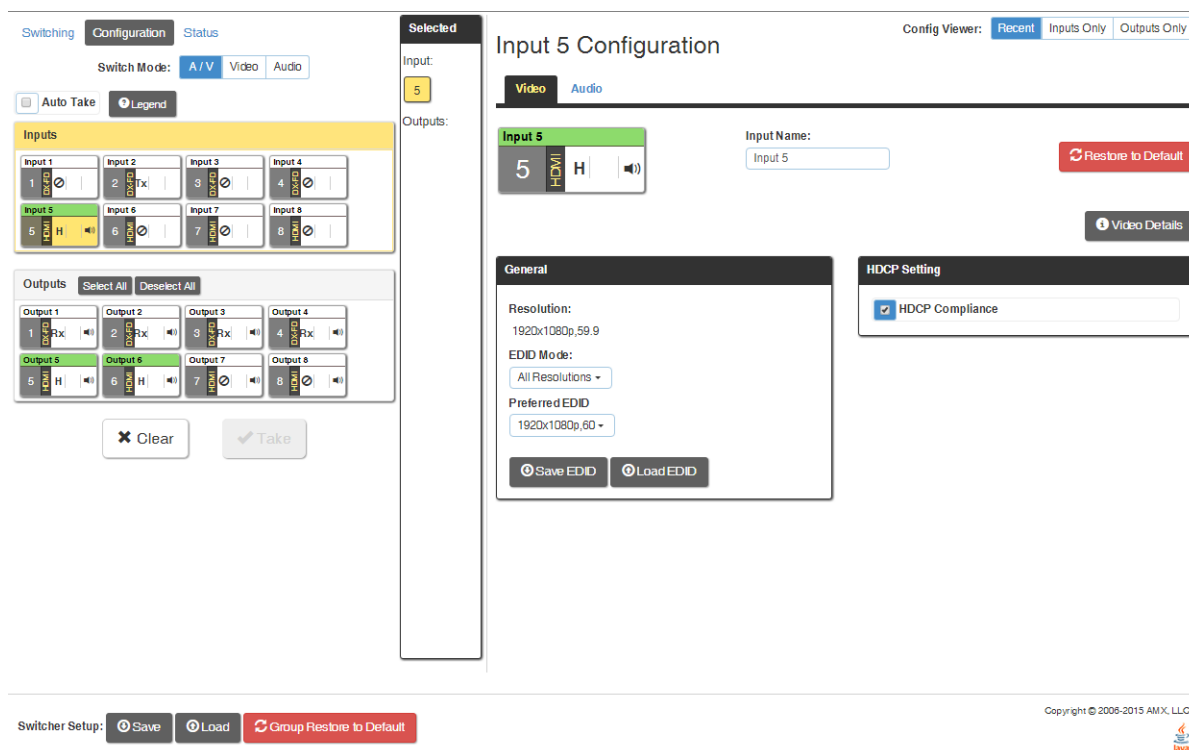
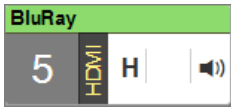
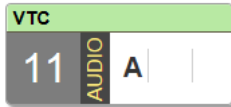

FIG. 101 Configuration page

Configuration Page Components	
Switching page components	All of the components from the Switching page are compressed and displayed (for details, see previous section on the "Switching Page").
Input and Output buttons	Selected individually for configuration.
Input # or Output # Configuration	The heading above the Video and Audio tabs changes according to the input or output currently selected for configuration.
Video and Audio tabs	Click these tabs to configure the video or audio signal that is selected in the Switching view (default = Video). The signal will be either input or output depending on the Config Viewer button selection. The setting options vary depending on the signal.

Configuration Page Components (Cont.)	
Config Viewer buttons	<p>The Recent, Inputs Only, and Outputs Only buttons allow you to choose the source or destination signal to be configured. Settings for the current Config Viewer remain when leaving the page and reactivate upon return. When the Recent button is clicked, the last selected input or output and its settings display. If no inputs or outputs are selected before opening the page, then the information will be cleared.</p> <ul style="list-style-type: none"> When the Inputs Only button is selected, clicking an output button in the Switching components will result in blank Configuration information; the same is true for selecting the Outputs Only button and then clicking an input button. When selecting a signal to configure, the Config Viewer button selection, Inputs Only or Outputs Only, must correspond to the input or output button selected. <p>Selecting any video or audio signal button will display corresponding information as follows:</p>
Input or Output button	<p>An enlargement of the button selected under Switching (or from the Switching page) appears on the Configuration side with the source name and number, plus signal details. For an explanation of the button's details, click the Legend button).</p> <div style="display: flex; justify-content: space-around; align-items: center;"> <div style="text-align: center;">  <p>Video button</p> </div> <div style="text-align: center;">  <p>Audio button</p> </div> </div>
Input Name or Output Name field	<p>Use to label the buttons in the Switching pane (and on the Switching page). Type the name in the field and press Enter on the keyboard.</p> <ul style="list-style-type: none"> Input and Output Names do not allow spaces. Either omit spaces (e.g., Input1, TV12, GameRoom) or use an underscore in place of a space (e.g., Input_1, TV_12, Game_Room). For ease of access, we suggest creating Input and Output Names using a naming convention with the port number followed by a unique name, i.e. "<port#><name>," using 31 characters or less.
Restore to Default (red) button	<p>Click to open the Warning dialog, which requires you to select the Yes button to restore the currently selected input or output to its factory default settings:</p> <div style="border: 1px solid #ccc; padding: 10px; background-color: #fff;"> <p style="background-color: #fff9c4; padding: 5px;">Warning ✕</p> <p>This will override configuration values to default. Do you wish to restore this port's audio input configuration?</p> <div style="text-align: right; margin-top: 10px;"> <input type="button" value="✕ No"/> <input checked="" type="button" value="✔ Yes"/> </div> </div>
Video Details or Audio Details button	<p>Click to display additional video or audio details for inputs or outputs, depending on current selection (video: colorSpace, flags, pixelclock, etc.; audio: CTS Value, N Value, Audio Mute State, etc.). Examples of both Video Input and Output Details are shown in FIG. 102. Audio details are similar.</p>
Video, DXLink, and Audio settings	<p>The settings section of the Configuration page changes depending on the type of signal, whether it is an input or an output, and whether a DXLink unit is attached. A variety of interface controls are used to change the settings (e.g., buttons, sliders, drop-down lists) depending on the values involved. Details for these settings follow this section.</p>
Switcher Setup button options are available on both the Switching and the Configuration pages.	

Video Input and Output Details Windows

Video and audio flag names and descriptions (as presented in the Video Input and Output Details Windows - FIG. 102) are provided below:

Video Input Details	Video Output Details																																																								
<table border="0"> <tr> <td>Port:</td> <td>5</td> <td>Flags:</td> <td>1079</td> </tr> <tr> <td>Horizontal Active:</td> <td>1920</td> <td>Vertical Active:</td> <td>1080</td> </tr> <tr> <td>FieldRate:</td> <td>5999</td> <td>Color Depth:</td> <td>8</td> </tr> <tr> <td>Colorspace:</td> <td>0</td> <td>Colorimetry:</td> <td>0</td> </tr> <tr> <td>Ext. Colorimetry:</td> <td>0</td> <td>Replication:</td> <td>1</td> </tr> <tr> <td>VIC:</td> <td>16</td> <td>Pixel Clock:</td> <td>14800000</td> </tr> <tr> <td>Horizontal Frequency:</td> <td>67490</td> <td>Source Channel:</td> <td>0</td> </tr> </table>	Port:	5	Flags:	1079	Horizontal Active:	1920	Vertical Active:	1080	FieldRate:	5999	Color Depth:	8	Colorspace:	0	Colorimetry:	0	Ext. Colorimetry:	0	Replication:	1	VIC:	16	Pixel Clock:	14800000	Horizontal Frequency:	67490	Source Channel:	0	<table border="0"> <tr> <td>Port:</td> <td>5</td> <td>Flag:</td> <td>1143</td> </tr> <tr> <td>Horizontal Active:</td> <td>1280</td> <td>Vertical Active:</td> <td>720</td> </tr> <tr> <td>FieldRate:</td> <td>6009</td> <td>Color Depth:</td> <td>8</td> </tr> <tr> <td>Colorspace:</td> <td>0</td> <td>Colorimetry:</td> <td>0</td> </tr> <tr> <td>Ext. Colorimetry:</td> <td>0</td> <td>Replication:</td> <td>0</td> </tr> <tr> <td>VIC:</td> <td>0</td> <td>Pixel Clock:</td> <td>7400000</td> </tr> <tr> <td>Horizontal Frequency:</td> <td>45068</td> <td>Source Channel:</td> <td>1</td> </tr> </table>	Port:	5	Flag:	1143	Horizontal Active:	1280	Vertical Active:	720	FieldRate:	6009	Color Depth:	8	Colorspace:	0	Colorimetry:	0	Ext. Colorimetry:	0	Replication:	0	VIC:	0	Pixel Clock:	7400000	Horizontal Frequency:	45068	Source Channel:	1
Port:	5	Flags:	1079																																																						
Horizontal Active:	1920	Vertical Active:	1080																																																						
FieldRate:	5999	Color Depth:	8																																																						
Colorspace:	0	Colorimetry:	0																																																						
Ext. Colorimetry:	0	Replication:	1																																																						
VIC:	16	Pixel Clock:	14800000																																																						
Horizontal Frequency:	67490	Source Channel:	0																																																						
Port:	5	Flag:	1143																																																						
Horizontal Active:	1280	Vertical Active:	720																																																						
FieldRate:	6009	Color Depth:	8																																																						
Colorspace:	0	Colorimetry:	0																																																						
Ext. Colorimetry:	0	Replication:	0																																																						
VIC:	0	Pixel Clock:	7400000																																																						
Horizontal Frequency:	45068	Source Channel:	1																																																						

FIG. 102 Video Input Details and Video Output Details Windows

NOTE: The Output Video Details provided by the System Configuration interface correspond to information at the output board prior to scaling, not what is sent to the destination display.

Video Input Window - Video Flag Information	
Flag Text	Indicates
NoVideo	No video signal present, or signal is unstable
EmbAud	Embedded audio data (ASP or HBR) and ACR data present
Invalid	Video signal detail(s) are unreliable or unavailable
HDMI	Video mode set to HDMI
NotHDCP	HDCP not supported
FRun	Free Run video present
HDCP	HDCP content present
HDCPErr	HDCP sub-system currently failing authentication
3D	3D video present
I	Interlaced video present
NoCable	Video cable not detected
Analog	Analog video source
Scrambled	TDMS stream is scrambled: Video Tier 3 signal requires HDMI 2.0 capable components throughout the video path
Premium	Video containing HDCP 2.2 Premium Content: requires HDCP 2.2 compliant components throughout the video path
Unsupported	Video route to channel exceeds output channel hardware's supported video format tier

Audio Input Window - Video Flag Information	
Flag Text	Indicates
NoAudio	No audio signal present, or signal is unstable
EmbAud	Embedded audio data (ASP or HBR) and ACR data present
Invalid	Audio signal detail(s) are unreliable or unavailable
Mute	Audio is Muted
UInj	Upstream injected audio present
LInj	Local injected audio present
FRun	Free Run video present
LPCM	Audio signal is L-PCM
InvCHST	No audio or distorted audio
Mono	Audio signal is Mono

HDR Colorimetry Information			
Color Space	Colorimetry	Ext. Colorimetry	Type
RGB	Extended	6	BT.2020 RGB
YCbCr	Extended	6	BT.2020 YCbCr
YCbCr	Extended	5	BT.2020 YCbCrCrc

Video Settings

Video settings display when the Switch Mode is A/V or Video, the Video tabbed view is selected, and a specific input or output is selected.

Inputs Only - General

FIG. 103 Video Settings - Inputs Only - General

Video Settings - Inputs Only - General	
Resolution	Displays the detected input Resolution (read-only)
EDID Mode	In the drop-down list, select the EDID (<i>All Resolutions, Wide-Screen, Full-Screen, 4K or 4K60</i>) to be presented to the source
Preferred EDID	In the drop-down list, select the specific resolution/refresh rate to be presented as the preferred resolution to the source
HDR (4k60 boards only)	Drop-down list options are <i>None</i> or <i>HDR10</i> .
Save EDID button	Use to save a copy of the EDID from the selected display to your PC/tablet device
Load EDID button	Use to load a saved EDID to the selected input from your PC or device (EDID files are available in the AMX EDID Library or they can be saved from a specific input or output.)

NOTE: When EDID Mode/All Resolutions is selected, the Preferred EDID drop-down list includes both standard EDIDs and Video Information Code (VIC) EDIDs (denoted by either a "p" or an "i"). For a complete list of VIC EDIDs for your input boards see the "EDID Resolutions Supported through Local DDC" section of the applicable board chapter.

Inputs Only - HDCP Setting

FIG. 104 Video Settings - Inputs Only - General

Video Settings - Inputs Only - HDCP Setting	
HDCP Compliance	Click enable/disable HDCP compliance. When disabled, this serves to notify the source that HDCP encrypted content is not allowed so that it will not try to send encrypted content. For additional EDID configuration information, see page 199.

Outputs Only - General

FIG. 105 Video Settings - Outputs Only - General

Video Settings - Outputs Only - General	
Scaling (Mode)	Click the button for the desired Scaling mode (Auto, Manual, or Bypass).
Resolution	For outputs with a scaler - In the drop-down list, select the output resolution/refresh rate to be used by the scaler; select the "Show only EDID Display Supported (DS)" check box if desired. For outputs without a scaler: The resolutions shown is the resolution coming in and being passed through to the output.
Aspect Ratio	Click either Maintain or Stretch (Zoom and Anamorphic are also available for DXLink outputs)
Save EDID	Click to save a copy of the EDID from the connected display to your PC/tablet device

NOTE: The scaler may not support all of the Display Supported resolutions. If not, select a scaled resolution from the larger list of DGX supported resolutions.

Setting a Manual Override for a Scaled Output

1. Select the *Manual* button.
2. From the Resolution drop-down list, select the resolution/refresh rate.

NOTE: Click the *Show only EDID Display Supported (DS)* check box to narrow the drop-down list to show only those resolution/refresh rate options marked DS (Display Supported).

Display Settings

FIG. 106 Display Settings

Video Settings - Display Settings	
Video Mute	Click the check box to mute the video
Video Freeze	Click the check box to freeze the video
Test Pattern	In the drop-down list, select Off, Color Bar, Gray Ramp, SMPTE Bar, HiLo Trak, Pluge, or X-Hatch
Blank Color	In the drop-down list, select Black or Blue
Allow Display Sleep	Click the check box to allow the display to go to sleep after the specified time in seconds in the "Display Sleep Delay(s)" field
Display Sleep Delay(s)	Enter the delay in seconds that the display will remain awake after the video route has been disconnected or the input signal is removed. Note: While most monitors handle the sleep function well, some monitors continually attempt to wake up, resulting in constant or intermittent screen blanking when no video is present. For the video output attached to the problematic monitor, either uncheck the Allow Display Sleep option and set the Blank Color or set <code>VIDOUT_SLEEP-DISABLE</code> and <code>VIDOUT_BLANK-<color></code> (see page 228).

On-Screen Display

The screenshot shows the 'On-Screen Display' configuration window. At the top, there is a header 'On-Screen Display'. Below it, there is a checkbox labeled 'Enable OSD' which is checked. Underneath, there are two dropdown menus: 'OSD Color' is set to 'Blue' and 'OSD Position' is set to 'Bottom Right'.

FIG. 107 On-Screen Display

Video Settings - On-Screen Display	
Enable OSD	Click check box to enable/disable
OSD Color	In the drop-down list, select Black, Blue, White, or Yellow
OSD Position	In the drop-down list, select Top Left, Top Right, Bottom Left, or Bottom Right

Image Adjustments

The screenshot shows the 'Image Adjustments' configuration window. It features two horizontal slider bars. The first is labeled 'Brightness' and has a range from 0 to 100, with a slider knob positioned at 50. The second is labeled 'Contrast' and also has a range from 0 to 100, with a slider knob positioned at 50.

FIG. 108 Image Adjustments

Video Settings - Image Adjustments	
Brightness	Use the slider bar to adjust (range: 0 to 100)
Contrast	Use the slider bar to adjust (range: 0 to 100)

DXLink Video Settings

DXLink specific video settings display when a DXLink Twisted Pair or DXLink Fiber Transmitter or Receiver (or other DXLink equipment) is connected to the selected input or output. These settings display in addition to the normal video settings for the input or output described in the previous section. The Video tabbed view *must* be selected.

- Video Priority – click either the HDMI, Analog, or Manual button.
- AV Source – click Analog or Digital.
- Video Type – non-editable.
- DXLink Details button – click to display additional settings for the DXLink Transmitter (FIG. 109)

DXLink (Twisted Pair or Fiber) Transmitters (for selected video input)

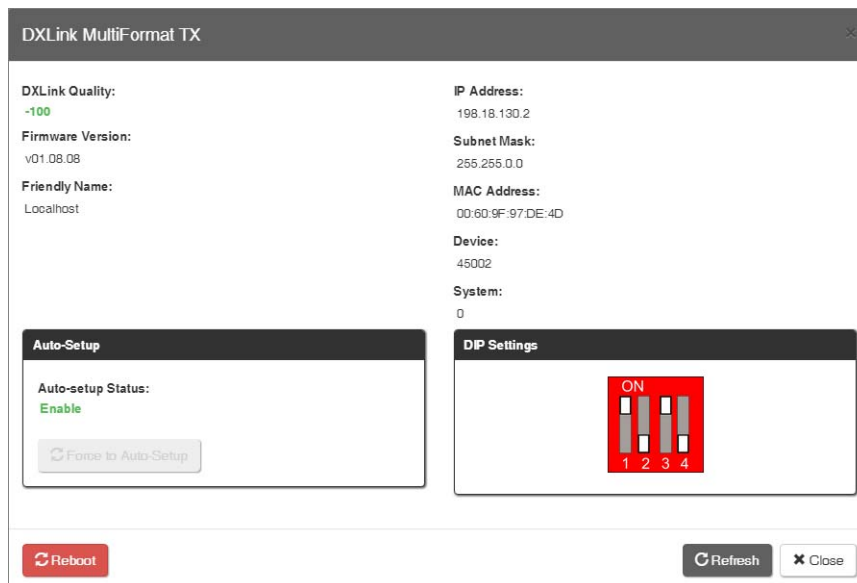

FIG. 109 DXLink (Twisted Pair or Fiber) Transmitters

DXLink Transmitters Settings	
DXLink Quality	green = good, red = poor <ul style="list-style-type: none"> • DXLink Twisted Pair quality range is from -100 to 0 with the best quality at -100 and the worst quality at 0. • DXLink Fiber quality range is from 0 to -100 with the best quality at 0 and the worst quality at -100.
Firmware Version	current version
Friendly Name	current name
IP Address	for auto-setup, displays integrated Master's IP address
Subnet Mask	current setting
D. P. S.	current setting
MAC Address	current setting
Auto-Setup	Status (Enable/Disable) and Force to Auto-setup button
DIP Settings	indicates settings on DIP switch
Reboot button	reboots TX
Refresh button	updates status of TX settings
VGA Settings (DXLink Twisted Pair only)	use sliders to adjust Phase, Horizontal Shift, and Vertical Shift settings.

IMPORTANT: The DXLink settings *are not* asynchronous. To obtain the latest information, the Refresh button in the dialog box that opens when the DXLink Details button is clicked must be clicked.

NOTE: The 4k wall plate transmitter will only show the DxLink Details button which will only provide DxLink Quality data.

DXLink (Twisted Pair or Fiber) Receivers (for selected video output)

- DXLink Details button – click to display additional settings for the DXLink Receiver (FIG. 110).

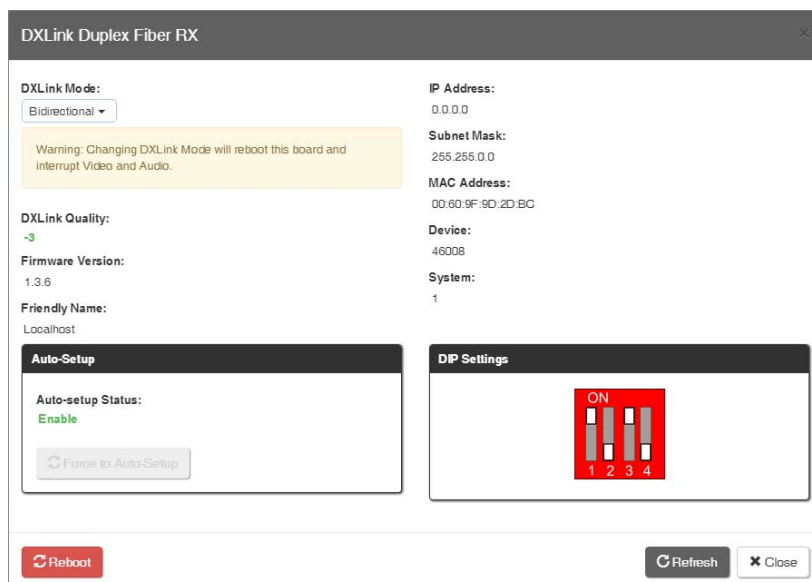

FIG. 110 DXLink (Twisted Pair or Fiber) Receivers

DXLink Receivers Settings	
DXLink Quality	green = good, red = poor <ul style="list-style-type: none"> • DXLink Twisted Pair quality range is from -100 to 0 with the best quality at -100 and the worst quality at 0. • DXLink Fiber quality range is from 0 to -100 with the best quality at 0 and the worst quality at -100.
Firmware Version	current version
Friendly Name	current name
IP Address	for auto-setup, displays integrated Master's IP address
Subnet Mask	current setting
D. P. S.	current setting
MAC Address	current setting
Auto-Setup	Status (Enable/Disable) and Force to Auto-setup button
DIP Settings	indicates settings on DIP switch
Reboot button	reboots RX
Refresh button	updates status of RX settings

Audio Settings

Audio settings display when the Switch Mode is A/V or Audio, the Audio tabbed view is selected, and a specific input or output is selected. The audio settings can be used to configure any digital signal processing required for the audio signal that is selected in the Switching view.

Inputs Only - General

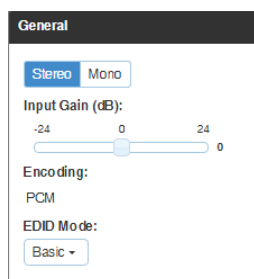

FIG. 111 Audio Settings - Inputs Only - General

Audio Settings - Inputs Only - General	
Stereo or Mono buttons	Setting this option to "Mono" audio on the input results in the left channel being sent to both the left and right output channels.
Input Gain (dB)	use the slider bar to adjust (-24 dB to +24 dB),
Encoding	PCM (read only)
EDID Mode	from the drop-down list, select the mode (Basic, PCM 2-Channel, PCM Multi-Channel, Dolby Digital, Dolby Digital + DTS, Dolby Digital + MPEG, Dolby Digital + AAC, Dolby TrueHD, Dolby Atmos, Dolby Digital Plus, or DTS HD Master Audio).

Compression

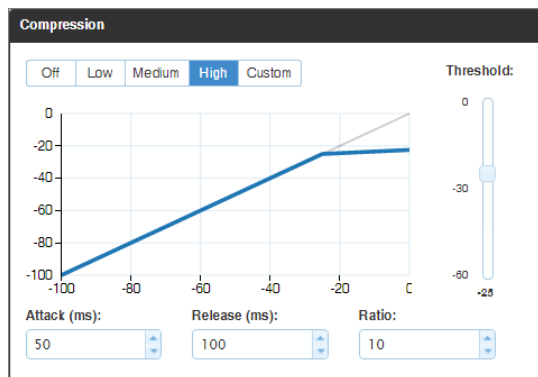

FIG. 112 Compression

Audio Settings - Compression	
Buttons at top	Click Off, Low, Medium, High, or Custom. Note: When in Low, Medium, or High, changes to any of the other Compression settings will automatically change the Compressor mode to Custom.
Threshold	Use the slider bar to adjust (range: 0 to -60).
Attack (ms),Release (ms),Ratio	Adjust the values in the boxes (either enter values or use the arrows)

Outputs Only - General

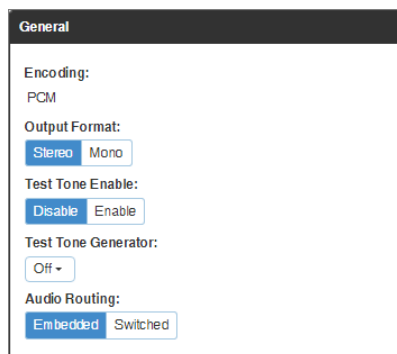

FIG. 113 Audio Settings - Outputs Only - General

Audio Settings - Outputs Only - General	
Encoding	PCM (read only)
Output Format	click Stereo or Mono. Note: Setting this option to "Mono" audio on the output results in the left and right channels being combined and sent to both the left and right output channels equally.
Test Tone Enable	click Disable or Enable.
Test Tone Generator	from the drop-down list, select Off, 60Hz, 250Hz, 400Hz, 1kHz, 3kHz, 5kHz, 10kHz, Pink Noise, or White Noise.
Audio Routing	click Embedded or Switched. Note: With Audio Switching Boards in the system, Audio Routing defaults to Switched.

Levels & Delay

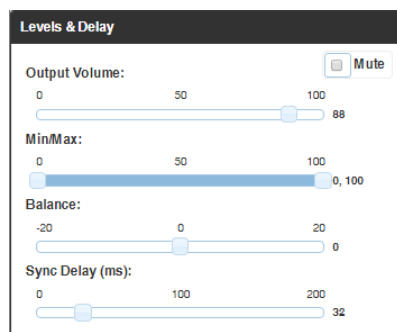

FIG. 114 Levels & Delay

Audio Settings - Levels & Delay	
Mute	click Mute if desired. Note: Changing the volume level will not un-mute the signal; however, the new volume level is saved and when the Mute button is deselected, the volume returns at the new level.
Output Volume	(0 to 100)
Min/Max	(0 to 100)
Balance	(-20 to 20, left to right)
Sync Delay (ms)	(0 to 200)

10-Band Parametric Equalizer

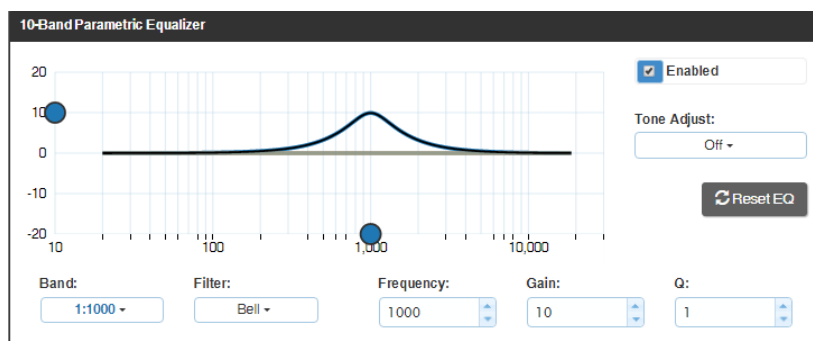

FIG. 115 10-Band Parametric Equalizer

Audio Settings - 10-Band Parametric Equalizer	
Enabled	this check box must be selected before the Equalizer options are available. Note: On reboot, the Enabled box always returns to the checked (default) state. To disable the Equalizer options over a reboot, set the "y" (vertical) vertex to 0 (zero).
Tone Adjust	use the drop-down box to select: Off, Voice, Music, or Movie (Tone Adjust is applied on top of any equalizer adjustments).
Reset EQ	Click to reset the all of the Equalizer values.
Blue Handles	Use the sliders (blue handles) to adjust Equalizer values.
Equalizer Drop-down menus	The following drop-down lists can also be used to adjust Equalizer values. <ul style="list-style-type: none"> Band – numbered from 1 to 10. Filter – the options are Bell, Band Pass, Band Stop, High Pass, Low Pass, Treble Shelf, and Bass Shelf. Frequency – the adjustment range is from 20 to 20000 (Hz). Gain – the adjustment range is from -12 to 12. Q – the adjustment range depends on the filter selected: <ul style="list-style-type: none"> Bell = 0.1 to 20 Band Pass = 0.1 to 20 Band Stop = 0.1 to 20 High Pass = 0.5 to 1.4 Low Pass = 0.5 to 1.4 Treble Shelf = 0.5 to 1 Bass Shelf = 0.5 to 1

DXLink Audio Settings

DXLink specific audio settings display when a DXLink Twisted Pair or DXLink Fiber Transmitter or Receiver (or other DXLink equipment) is connected to the selected input or output. These settings display in addition to the normal audio settings for the input or output described in the previous section. The Audio tabbed view *must* be selected.

DXLink (Twisted Pair or Fiber) Transmitter (for selected audio input)

FIG. 116 DXLink (Twisted Pair or Fiber) Transmitter Settings

DXLink Transmitters Settings	
Audio Priority	Click either the Auto or Manual button.
Audio Source	Click either the HDMI, SPDIF, or Analog button
DXLink Details button	Click to display additional settings for the DXLink Transmitter.

NOTE: The 4k wall plate transmitter will only show the DxLink Details button which will only provide DxLink Quality data.

DXLink TX Details

FIG. 117 DXLink Transmitters Details

DXLink Transmitters Details	
DXLink Quality	green = good; red = poor; number indicates degree or lack of quality
Firmware Version	current version
Friendly Name	current name
IP Address	for auto-setup, displays integrated Master's IP address
Subnet Mask	current setting
D. P. S.	current setting
MAC Address	current setting
Auto-Setup	Status (Enable/Disable) and Force to Auto-setup button
DIP Settings	indicates settings on DIP switch
Reboot button	reboots TX
Refresh button	updates status of TX settings

DXLink (Twisted Pair or Fiber) Receivers (for selected audio output)

FIG. 118 DXLink (Twisted Pair or Fiber) Transmitter Settings

DXLink Receivers Settings	
Active Output	Click either the HDMI, Analog, or All button.
DXLink Details button	Click to display additional settings for the DXLink Receiver

DXLink RX Details

FIG. 119 DXLink Receivers Details

DXLink Receivers Details	
DXLink Quality	green = good; red = poor; number indicates degree or lack of quality
Firmware Version	current version
Friendly Name	current name
IP Address	for auto-setup, displays integrated Master's IP address
Subnet Mask	current setting
D. P. S.	current setting
MAC Address	current setting
Auto-Setup	Status (Enable/Disable) and Force to Auto-Setup button
DIP Settings	indicates settings on DIP switch
Reboot button	reboots RX
Refresh button	updates status of RX settings

EDID Configuration

NOTE: Because signals routed through HDMI, DVI, DXLink Twisted Pair, and DXLink Fiber Boards in an Enova DGX 100 Series Switcher normally produce a quality image, you will not need the information in this section unless the installation has special EDID requirements.

A default EDID (Extended Display Identification Data) is stored on the input boards and/or Transmitters. This EDID, which gets presented to the source, includes all necessary timings, audio and video format support, and preferred resolutions for best performance.

Setting an Enova Standard EDID For an Input

1. From Configuration page / Switch Mode (on the left), click the Video button.
2. Check to be sure the Config Viewer on the top right is set to Inputs Only.
3. From the Switching pane on the left, select the video input.
4. Under General settings from the EDID Mode drop-down list, select the mode (*All Resolutions, Wide-Screen, Full-Screen, 4K, 4K60 or Custom*). This will load the Enova Standard EDID of that type.
5. If an alternate preferred resolution is desired, select the Preferred EDID from the drop-down list of resolutions/refresh rates.

Setting a Custom EDID from an Output Sink

1. From Configuration page / Switch Mode (on the left), click the Video button.
2. Check to be sure the Config Viewer on the top right is set to Outputs Only.
3. From the Switching pane on the left, select the video output.
4. Return to the Input Configuration Page, use the *Load EDID* button to fetch the saved EDID from your PC and load in onto the input.

Setting the EDID Mode For an Audio Input

1. From Configuration page / Switch Mode (on the left), click the Audio button.
2. Check to be sure the Config Viewer on the top right is set to Inputs Only.
3. From the Switching page components on the left, select the audio input.

Under General settings from the EDID Mode drop-down list, select the mode: Basic, PCM 2-Channel, PCM Multi-Channel, Dolby Digital, Dolby Digital + DTS, Dolby Digital + MPEG, Dolby Digital + AAC, Dolby TrueHD, DTS HD Master, Dolby Atmos, or Dolby Digital Plus.

Loading and Saving EDIDs

For custom EDIDs, click the Load EDID button and browse for the .edid file on your device/computer. Once the EDID is loaded, make any necessary changes and use the Save EDID button to save the altered .edid file to your device/computer.

NOTE: Some devices run on a secured file-system. As such, file-system operations (e.g., Load and Save operations) may not be supported by the device's default capabilities and may require downloading a file manager application.

Status Page

The Status page is used to check a number of the switcher's components and their states. The components (from top to bottom of page) display status for Alarms, the Chassis, the Master CPU Board, Input and Output Boards, and Input and Output Expansion Audio Boards. A quick glance at this page will indicate whether the system is running okay (green text will state OK) or if any thing is failing (red text will state FAIL.)

IMPORTANT: The Status page settings are not asynchronous. To obtain the latest information, the Refresh button must be clicked.

The example in FIG. 120 is based on an Enova DGX 3200 Switcher with two each standard Input and Output Boards, as well as two Expansion Audio Boards.

The screenshot displays the 'Status' page of the Enova DGX Switcher Configuration interface. The page is organized into several sections, each with a table of component status. Annotations on the left and right sides point to specific elements:

- System Auto-Setup:** Points to the 'System Auto-Setup' button.
- Alarms:** Points to the 'Fan Alarm: OK', 'Power Alarm: FAIL', and 'Temperature Alarm: OK' indicators, which are highlighted with a red circle.
- Refresh:** Points to the 'Refresh' button at the top right.
- Chassis:** Points to the 'AMX Enera DGX 400 (FC1000-00) Chassis' section.
- Master CPU (MCPU) Board:** Points to the 'Main CPU Board' table.
- Input Boards:** Points to the 'Input Boards' table.
- Output Boards:** Points to the 'Output Boards' table.
- Input Audio Expansion Boards:** Points to the 'Input Expansion Audio Boards' table.
- Output Audio Expansion Boards:** Points to the 'Output Expansion Audio Boards' table.
- Refresh:** Points to the 'Refresh' button at the bottom right.

The tables provide detailed status for each component, including fields for Slot, Status, Type, PG, Version, Temperature, Temp Alarm, Power Alarm, and a Reboot button.

FIG. 120 Status Page

Status Page Components	
System Auto-Setup check box	Select to place the system in auto-setup mode (i.e., the mode wherein the system requires only a single IP address for the integrated Master, and each endpoint is automatically configured for communication via a private LAN hosted by the integrated Master). The following must be adhered to when using auto-setup mode (default): <ul style="list-style-type: none"> • Endpoints <i>must</i> be set to DHCP Mode (default) • Endpoints <i>must</i> use NDP Master connection mode (default) • Endpoints <i>must not</i> be currently bound (traditional NetLinx binding) to a Master • Endpoints DIP switch setting for Toggle #3 (network connectivity) is ignored while in auto-setup mode Some devices run on a secured file-system. As such, file-system operations (e.g., Load and Save operations) may not be supported by the device's default capabilities and may require downloading a file manager application.
Alarms	If any are red, consult the individual Fan, Power, and Temperature components on the page to help pinpoint the problem.
Refresh button	If necessary, use the Refresh button to view system status changes.
Chassis	This section contains readouts for individual fan speeds, individual power supply status, and the current temperature of the chassis (shown in degrees Celsius). Each readout displays in a color to convey statuses of OK , Fail , or no problems detected (black). Fan speed information is displayed by individual fans (Fan #) and the fan assembly where each fan is located (FAN ASM #). Power supply and temperature information is available in each switcher's General Specifications table in the "Product Overview and General Specifications" chapter.
Master CPU (MCP) Board	This section displays information for Status, Model number of the integrated Master, FG (part) number, Version, Temperature (actual degrees in Celsius with OK or FAIL status), and Power (OK or FAIL status).
Input and Output Board	This section gives detailed information for each input or output board in the enclosure: Slot, Status, Type, FG (part) number, Version, Temperature (actual degrees in Celsius with OK or FAIL status), and Power (OK or FAIL status). A red Reboot button at the right cycles power to the individual board.
Input and Output Audio Expansion Boards	This section gives detailed information for each expansion input or output board in the enclosure: Slot, Status, Type, FG (part) number, Version, Temperature (actual degrees in Celsius with OK or FAIL status), and Power (OK or FAIL status). A red Reboot button at the right cycles power to the individual board.
Switcher Setup (Save, Load, and Group Restore to Default) buttons	After a system has been set up per the installation's requirements, the configuration can be saved and reloaded onto another system(s) or backup system(s) for reuse. The Group Restore to Default button returns the system to its last previously saved state. This button will restore control values to default (initial) values. (This Restore button performs the same function for the entire system as the Configuration page's Restore to Default button does for individual inputs or outputs.)
Refresh button	If necessary, use the Refresh button to view system status changes.

System Configuration Interface Tips

- To change the network connection type from DHCP (default) to Static IP – navigate to Network/IPv4 Setup; click on Specific IP Address; enter values into the IP Address, Subnet Mask, and Gateway fields; then click Accept.
- To enable/disable auto-setup – navigate to Switcher/Status; click the System Auto-Setup check box to add a check mark (enabled) or remove a check mark (disabled).
- To route audio without the benefit of audio options available via the interface – navigate to Switcher/Configuration; select Audio Switch Mode; select Outputs Only in the Config Viewer options; select the desired output; select Switched Audio Routing from the General options.

NetLinx Studio

Overview

Each Enova DGX 100 Series Switcher contains an integrated NetLinx NX Central Controller (Master). Control for Enova DGX 100 Series Switchers is provided through several methods:

- Enova DGX Switcher Configuration (an onboard web configurator) – See the *Switching, Configuration, and Status* chapter (page 127)
- NetLinx Studio – See below
- SEND_COMMANDs – See the NetLinx Programming chapter (page 211)
- Control panel – See the Control Panel Operation chapter (page 246)
- DGX_SHELL Commands – See Appendix C–DGX_SHELL Commands (page 273)
- BCS Commands – See the *Basic Control Structure (BCS) Protocol Programming Guide* at www.amx.com

NOTE: When routing audio to or from Audio Switching Board connectors using BCS (Basic Control Structure protocol), switching audio must be executed on Level 2 (see the BCS Programming Guide at www.amx.com).

This chapter focuses on control via NetLinx Studio, AMX's programming, organization, and support software. This chapter provides NetLinx Studio information for the Network Administrator during initial setup.

- Installing NetLinx Studio
- Connecting to a Master
- Enabling control characters

Additional information for NetLinx Studio is covered in *WebConsole & Programming Guide - NX-Series Controllers* at www.amx.com.

NOTE: Instructions on traditional NetLinx binding of DXLink Fiber and DXLink Twisted Pair Transmitters and Receivers are available within those products' Hardware Reference Manuals.

NOTE: Additional support for NetLinx code development is available through the "Language Reference Guide – NetLinx Programming Language" at www.amx.com.

Installing NetLinx Studio and Connecting to a Master

System Requirements

Minimum web browser requirements – Microsoft Internet Explorer 7.0 or later, Mozilla Firefox 3.6.8 or later, or any other web browser compatible with these browsers.

NOTE: User experience may differ due to browser support for HTML5.

NOTE: Best practices for control of the integrated Master include using the most up-to-date version of control software.

Installing NetLinx Studio

1. Download NetLinx Studio from www.amx.com/products/NetLinxStudio.asp (requires login permissions).
2. Extract the downloaded files (files are compressed).
3. Run NetLinx Studio Setup.
4. **Optional** – review the NetLinx Studio ReadMe file.
5. Launch NetLinx Studio.

NOTE: The steps below assume that the Enova DGX is powered on and connected to the public LAN via the LAN 100/1000 port on the enclosure's CPU.

Connecting To a NetLinx Master

1. Launch NetLinx Studio.
2. From the Settings Menu, select Workspace Communication Settings. The Workspace Communication Settings dialog opens.
3. Click Default Settings. The Communication Settings dialog opens.
4. Select the Network tab.

If the system is displayed in the list – select the system, click the Select button, and then skip to Step 6.

- or -

If the system is not in the list – click the Listen for Masters button. The Listen for Masters dialog opens.
5. Click the Start Listening button. When the system appears in the list, click the Stop Listening button, select the system, and click the Select to Add button. Click Exit.
6. In the Communication Settings dialog, select the system and click the Select button.
7. Click OK to exit the Communication Settings dialog. Click OK to exit the Workspace Communication Settings dialog.
8. Right-click in the Workspace Bar and select Refresh System OnLine Tree. The Workspace Bar refreshes with the system displayed.

Confirming Board Versions

Enova DGX enclosures and boards typically ship with the latest firmware available. If the firmware on any board installed in the enclosure does not match the firmware version the enclosure expects, a firmware mismatch occurs. To resolve a firmware mismatch, the latest available firmware .kit file (which contains firmware for both boards and enclosure) must be sent to the enclosure.

Confirm Board Versions

1. Launch NetLinx Studio and connect to the DGX Master.
2. Open the OnLine Tree tab, right-click in the Workspace Bar field and select Refresh System Online Tree.
3. Expand the 5002 device and confirm compatible board versions (or mismatch).
4. If a mismatch is present, send the latest firmware .kit file to the enclosure.

Sending a Firmware .kit File to the Enclosure

1. Navigate to your system's product page and download and unzip the "Enova DGX 100 Series Enclosure Firmware" .zip file.
2. Launch NetLinx Studio and navigate to the OnLine Tree.
3. Right-click on the 5002 device and select Firmware Transfer.
4. Click the Browse button and navigate to the downloaded file target directory.
5. Select the file for the Enova DGX from the Files list. Click Send.
 - a. During the switcher's upgrade process, the 5002 device stays offline and the control panel and System Configuration interface (System/Devices/Switcher Update Status) display upgrade status messages.
 - b. Once the upgrade is complete, the 5002 device comes back online and the System Configuration interface upgrade status reports that the system is rebooting.

Enabling Control Characters in a Terminal or Telnet Session

Control characters (non-alphabet characters) are not enabled by default, and so must be enabled in order to use them in terminal sessions (including Telnet).

1. Launch NetLinx Studio.
2. From the Settings Menu, select Preferences. The Preferences dialog opens.
3. On the left side of the dialog box, select Terminal - TELNET Windows.
4. On the right side of the dialog box (near the top), check the box to Send Ctrl characters to port.
5. Click OK.

NetLinx Studio Tips

- To launch the System Configuration interface from NetLinx Studio – right-click on the integrated Master and select Web Control Page/Launch Web Control Page via either NetLinx Studio or your default browser.
- To launch a Telnet session from NetLinx Studio – right-click on the integrated Master and select TELNET Window/Launch TELNET Window via either NetLinx Studio or a User Defined Program.
- To launch a terminal session from NetLinx Studio – select Tools/Terminal Session and configure the connection for either serial or USB settings.
- To discover the integrated Master's IP address from NetLinx Studio – right-click on the integrated Master and select Show Device Properties.
- To set AxLink device numbers from NetLinx Studio – select Tools/DIP Switch... and then make selections from the DIP Switch 2.0 applet. For more information on AxLink Devices, see the section "Attaching an AxLink Device" on page 76.

Integrated Master - NetLinx Programming

Overview

IMPORTANT: The `SEND_COMMANDS` listed in this chapter are for the Switcher, Video Input and Output Boards, and Audio Switching Input and Output Boards. For information on using NetLinx Studio, the System Configuration interface, and additional NetLinx commands, see the "WebConsole & Programming Guide – NX-Series Controllers" (available at www.amx.com).

The integrated NetLinx Master on the Enova DGX Switcher recognizes `SEND_COMMANDS`. Use NetLinx Studio (v4.0 or later is required) to send these commands to the Enova DGX Switcher, or use these commands in standard compiled NetLinx Programming code running on the integrated NetLinx Master.

The Device in <Device:Port:System> is the Enova DGX enclosure's device number (see "Device Numbering" below).

NOTE: If a single Master control point is desired for multiple Enova DGX enclosures, write the NetLinx code to provide the connection between the Masters.

Device Numbering

The NX Master number (00000) and the Device ID number (default 05002) are listed in NetLinx Studio's OnLine Tree (FIG. 121). The Device number is also listed in the System Configuration interface (under System/Devices).

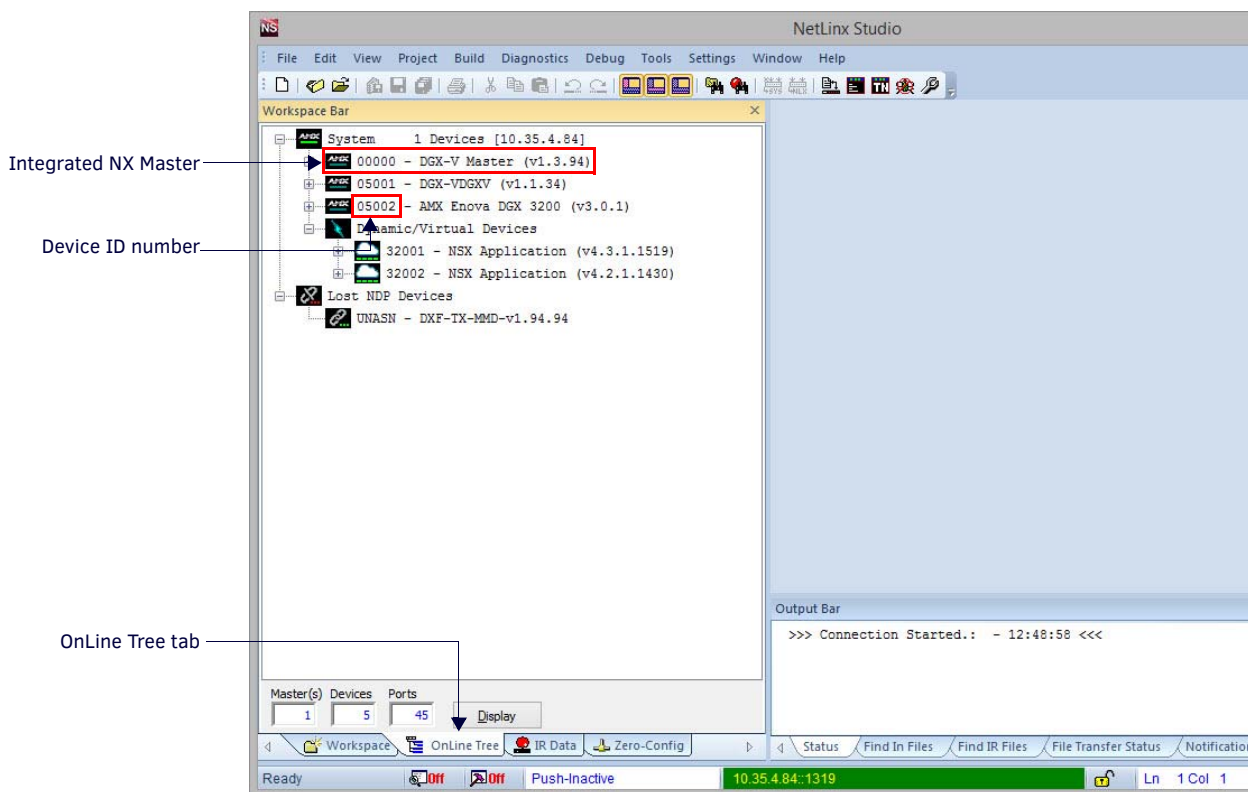

FIG. 121 NetLinx Studio OnLine Tree - indicating Master number and device number and ports for Enova DGX

NOTE: For additional information on using NetLinx Studio, refer to the "Instruction Manual – NetLinx Studio" (at www.amx.com).

NOTE: For NetLinx programming purposes, each AxLink device must be assigned a unique number to locate that device on the bus. The range for AxLink device numbers is 1-255.

IMPORTANT: Best practices for using `SEND_COMMANDS` with DXLink endpoints include sending commands to the specific input or output port of the Enova DGX switcher (e.g., 5002:4:0 for input/output channel 4).

Enclosure Port Mapping

Enova DGX 800 Port Mapping

Input Port Mapping		
Port #	Description	Address
1	Audio/Video Input 1	5002:1:0
2	Audio/Video Input 2	5002:2:0
3	Audio/Video Input 3	5002:3:0
4	Audio/Video Input 4	5002:4:0
5	Audio/Video Input 5	5002:5:0
6	Audio/Video Input 6	5002:6:0
7	Audio/Video Input 7	5002:7:0
8	Audio/Video Input 8	5002:8:0
9	Audio Input 9	5002:9:0
10	Audio Input 10	5002:10:0
11	Audio Input 11	5002:11:0
12	Audio Input 12	5002:12:0
13	Audio Input 13	5002:13:0
14	Audio Input 14	5002:14:0
15	Audio Input 15	5002:15:0
16	Audio Input 16	5002:16:0
17	down-mix Input 17	5002:17:0

Output Port Mapping		
Port #	Description	Address
1	Audio/Video Output 1	5002:1:0
2	Audio/Video Output 2	5002:2:0
3	Audio/Video Output 3	5002:3:0
4	Audio/Video Output 4	5002:4:0
5	Audio/Video Output 5	5002:5:0
6	Audio/Video Output 6	5002:6:0
7	Audio/Video Output 7	5002:7:0
8	Audio/Video Output 8	5002:8:0
9	Audio Output 9	5002:9:0
10	Audio Output 10	5002:10:0
11	Audio Output 11	5002:11:0
12	Audio Output 12	5002:12:0
13	Audio Output 13	5002:13:0
14	Audio Output 14	5002:14:0
15	Audio Output 15	5002:15:0
16	Audio Output 16	5002:16:0

Enova DGX 1600 Port Mapping

Input Port Mapping		
Port #	Description	Address
1	Audio/Video Input 1	5002:1:0
2	Audio/Video Input 2	5002:2:0
3	Audio/Video Input 3	5002:3:0
4	Audio/Video Input 4	5002:4:0
5	Audio/Video Input 5	5002:5:0
6	Audio/Video Input 6	5002:6:0
7	Audio/Video Input 7	5002:7:0
8	Audio/Video Input 8	5002:8:0
9	Audio/Video Input 9	5002:9:0
10	Audio/Video Input 10	5002:10:0
11	Audio/Video Input 11	5002:11:0
12	Audio/Video Input 12	5002:12:0
13	Audio/Video Input 13	5002:13:0
14	Audio/Video Input 14	5002:14:0
15	Audio/Video Input 15	5002:15:0
16	Audio/Video Input 16	5002:16:0
17	Audio Input 17	5002:17:0
18	Audio Input 18	5002:18:0
19	Audio Input 19	5002:19:0
20	Audio Input 20	5002:20:0
21	Audio Input 21	5002:21:0
22	Audio Input 22	5002:22:0
23	Audio Input 23	5002:23:0
24	Audio Input 24	5002:24:0
25	down-mix Input 25	5002:25:0

Output Port Mapping		
Port #	Description	Address
1	Audio/Video Output 1	5002:1:0
2	Audio/Video Output 2	5002:2:0
3	Audio/Video Output 3	5002:3:0
4	Audio/Video Output 4	5002:4:0
5	Audio/Video Output 5	5002:5:0
6	Audio/Video Output 6	5002:6:0
7	Audio/Video Output 7	5002:7:0
8	Audio/Video Output 8	5002:8:0
9	Audio/Video Output 9	5002:9:0
10	Audio/Video Output 10	5002:10:0
11	Audio/Video Output 11	5002:11:0
12	Audio/Video Output 12	5002:12:0
13	Audio/Video Output 13	5002:13:0
14	Audio/Video Output 14	5002:14:0
15	Audio/Video Output 15	5002:15:0
16	Audio/Video Output 16	5002:16:0
17	Audio Output 17	5002:17:0
18	Audio Output 18	5002:18:0
19	Audio Output 19	5002:19:0
20	Audio Output 20	5002:20:0
21	Audio Output 21	5002:21:0
22	Audio Output 22	5002:22:0
23	Audio Output 23	5002:23:0
24	Audio Output 24	5002:24:0

Enova DGX 3200 Port Mapping

Input Port Mapping		
Port #	Description	Address
1	Audio/Video Input 1	5002:1:0
2	Audio/Video Input 2	5002:2:0
3	Audio/Video Input 3	5002:3:0
4	Audio/Video Input 4	5002:4:0
5	Audio/Video Input 5	5002:5:0
6	Audio/Video Input 6	5002:6:0
7	Audio/Video Input 7	5002:7:0
8	Audio/Video Input 8	5002:8:0
9	Audio/Video Input 9	5002:9:0
10	Audio/Video Input 10	5002:10:0
11	Audio/Video Input 11	5002:11:0
12	Audio/Video Input 12	5002:12:0
13	Audio/Video Input 13	5002:13:0
14	Audio/Video Input 14	5002:14:0
15	Audio/Video Input 15	5002:15:0
16	Audio/Video Input 16	5002:16:0
17	Audio/Video Input 17	5002:17:0
18	Audio/Video Input 18	5002:18:0
19	Audio/Video Input 19	5002:19:0
20	Audio/Video Input 20	5002:20:0
21	Audio/Video Input 21	5002:21:0
22	Audio/Video Input 22	5002:22:0
23	Audio/Video Input 23	5002:23:0
24	Audio/Video Input 24	5002:24:0
25	Audio/Video Input 25	5002:25:0
26	Audio/Video Input 26	5002:26:0
27	Audio/Video Input 27	5002:27:0
28	Audio/Video Input 28	5002:28:0
29	Audio/Video Input 29	5002:29:0
30	Audio/Video Input 30	5002:30:0
31	Audio/Video Input 31	5002:31:0
32	Audio/Video Input 32	5002:32:0
33	Audio Input 33	5002:33:0
34	Audio Input 34	5002:34:0
35	Audio Input 35	5002:35:0
36	Audio Input 36	5002:36:0
37	Audio Input 37	5002:37:0
38	Audio Input 38	5002:38:0
39	Audio Input 39	5002:39:0
40	Audio Input 40	5002:40:0
41	down-mix Input 41	5002:41:0

Output Port Mapping		
Port #	Description	Address
1	Audio/Video Output 1	5002:1:0
2	Audio/Video Output 2	5002:2:0
3	Audio/Video Output 3	5002:3:0
4	Audio/Video Output 4	5002:4:0
5	Audio/Video Output 5	5002:5:0
6	Audio/Video Output 6	5002:6:0
7	Audio/Video Output 7	5002:7:0
8	Audio/Video Output 8	5002:8:0
9	Audio/Video Output 9	5002:9:0
10	Audio/Video Output 10	5002:10:0
11	Audio/Video Output 11	5002:11:0
12	Audio/Video Output 12	5002:12:0
13	Audio/Video Output 13	5002:13:0
14	Audio/Video Output 14	5002:14:0
15	Audio/Video Output 15	5002:15:0
16	Audio/Video Output 16	5002:16:0
17	Audio/Video Output 17	5002:17:0
18	Audio/Video Output 18	5002:18:0
19	Audio/Video Output 19	5002:19:0
20	Audio/Video Output 20	5002:20:0
21	Audio/Video Output 21	5002:21:0
22	Audio/Video Output 22	5002:22:0
23	Audio/Video Output 23	5002:23:0
24	Audio/Video Output 24	5002:24:0
25	Audio/Video Output 25	5002:25:0
26	Audio/Video Output 26	5002:26:0
27	Audio/Video Output 27	5002:27:0
28	Audio/Video Output 28	5002:28:0
29	Audio/Video Output 29	5002:29:0
30	Audio/Video Output 30	5002:30:0
31	Audio/Video Output 31	5002:31:0
32	Audio/Video Output 32	5002:32:0
33	Audio Output 33	5002:33:0
34	Audio Output 34	5002:34:0
35	Audio Output 35	5002:35:0
36	Audio Output 36	5002:36:0
37	Audio Output 37	5002:37:0
38	Audio Output 38	5002:38:0
39	Audio Output 39	5002:39:0
40	Audio Output 40	5002:40:0

Enova DGX 6400 Port Mapping

Input Port Mapping		
Port #	Description	Address
1	Audio/Video Input 1	5002:1:0
2	Audio/Video Input 2	5002:2:0
3	Audio/Video Input 3	5002:3:0
4	Audio/Video Input 4	5002:4:0
5	Audio/Video Input 5	5002:5:0
6	Audio/Video Input 6	5002:6:0
7	Audio/Video Input 7	5002:7:0
8	Audio/Video Input 8	5002:8:0
9	Audio/Video Input 9	5002:9:0
10	Audio/Video Input 10	5002:10:0
11	Audio/Video Input 11	5002:11:0
12	Audio/Video Input 12	5002:12:0
13	Audio/Video Input 13	5002:13:0
14	Audio/Video Input 14	5002:14:0
15	Audio/Video Input 15	5002:15:0
16	Audio/Video Input 16	5002:16:0
17	Audio/Video Input 17	5002:17:0
18	Audio/Video Input 18	5002:18:0
19	Audio/Video Input 19	5002:19:0
20	Audio/Video Input 20	5002:20:0
21	Audio/Video Input 21	5002:21:0
22	Audio/Video Input 22	5002:22:0
23	Audio/Video Input 23	5002:23:0
24	Audio/Video Input 24	5002:24:0
25	Audio/Video Input 25	5002:25:0
26	Audio/Video Input 26	5002:26:0
27	Audio/Video Input 27	5002:27:0
28	Audio/Video Input 28	5002:28:0
29	Audio/Video Input 29	5002:29:0
30	Audio/Video Input 30	5002:30:0
31	Audio/Video Input 31	5002:31:0
32	Audio/Video Input 32	5002:32:0
33	Audio/Video Input 33	5002:33:0
34	Audio/Video Input 34	5002:34:0
35	Audio/Video Input 35	5002:35:0
36	Audio/Video Input 36	5002:36:0
37	Audio/Video Input 37	5002:37:0
38	Audio/Video Input 38	5002:38:0
39	Audio/Video Input 39	5002:39:0
40	Audio/Video Input 40	5002:40:0
41	Audio/Video Input 41	5002:41:0
42	Audio/Video Input 42	5002:42:0
43	Audio/Video Input 43	5002:43:0
44	Audio/Video Input 44	5002:44:0
45	Audio/Video Input 45	5002:45:0
46	Audio/Video Input 46	5002:46:0
47	Audio/Video Input 47	5002:47:0
48	Audio/Video Input 48	5002:48:0
49	Audio/Video Input 49	5002:49:0
50	Audio/Video Input 50	5002:50:0
51	Audio/Video Input 51	5002:51:0
52	Audio/Video Input 52	5002:52:0
53	Audio/Video Input 53	5002:53:0
54	Audio/Video Input 54	5002:54:0
55	Audio/Video Input 55	5002:55:0
56	Audio/Video Input 56	5002:56:0
57	Audio/Video Input 57	5002:57:0
58	Audio/Video Input 58	5002:58:0
59	Audio/Video Input 59	5002:59:0

Output Port Mapping		
Port #	Description	Address
1	Audio/Video Output 1	5002:1:0
2	Audio/Video Output 2	5002:2:0
3	Audio/Video Output 3	5002:3:0
4	Audio/Video Output 4	5002:4:0
5	Audio/Video Output 5	5002:5:0
6	Audio/Video Output 6	5002:6:0
7	Audio/Video Output 7	5002:7:0
8	Audio/Video Output 8	5002:8:0
9	Audio/Video Output 9	5002:9:0
10	Audio/Video Output 10	5002:10:0
11	Audio/Video Output 11	5002:11:0
12	Audio/Video Output 12	5002:12:0
13	Audio/Video Output 13	5002:13:0
14	Audio/Video Output 14	5002:14:0
15	Audio/Video Output 15	5002:15:0
16	Audio/Video Output 16	5002:16:0
17	Audio/Video Output 17	5002:17:0
18	Audio/Video Output 18	5002:18:0
19	Audio/Video Output 19	5002:19:0
20	Audio/Video Output 20	5002:20:0
21	Audio/Video Output 21	5002:21:0
22	Audio/Video Output 22	5002:22:0
23	Audio/Video Output 23	5002:23:0
24	Audio/Video Output 24	5002:24:0
25	Audio/Video Output 25	5002:25:0
26	Audio/Video Output 26	5002:26:0
27	Audio/Video Output 27	5002:27:0
28	Audio/Video Output 28	5002:28:0
29	Audio/Video Output 29	5002:29:0
30	Audio/Video Output 30	5002:30:0
31	Audio/Video Output 31	5002:31:0
32	Audio/Video Output 32	5002:32:0
33	Audio/Video Output 33	5002:33:0
34	Audio/Video Output 34	5002:34:0
35	Audio/Video Output 35	5002:35:0
36	Audio/Video Output 36	5002:36:0
37	Audio/Video Output 37	5002:37:0
38	Audio/Video Output 38	5002:38:0
39	Audio/Video Output 39	5002:39:0
40	Audio/Video Output 40	5002:40:0
41	Audio/Video Output 41	5002:41:0
42	Audio/Video Output 42	5002:42:0
43	Audio/Video Output 43	5002:43:0
44	Audio/Video Output 44	5002:44:0
45	Audio/Video Output 45	5002:45:0
46	Audio/Video Output 46	5002:46:0
47	Audio/Video Output 47	5002:47:0
48	Audio/Video Output 48	5002:48:0
49	Audio/Video Output 49	5002:49:0
50	Audio/Video Output 50	5002:50:0
51	Audio/Video Output 51	5002:51:0
52	Audio/Video Output 52	5002:52:0
53	Audio/Video Output 53	5002:53:0
54	Audio/Video Output 54	5002:54:0
55	Audio/Video Output 55	5002:55:0
56	Audio/Video Output 56	5002:56:0
57	Audio/Video Output 57	5002:57:0
58	Audio/Video Output 58	5002:58:0
59	Audio/Video Output 59	5002:59:0

Input Port Mapping		
60	Audio/Video Input 60	5002:60:0
61	Audio/Video Input 61	5002:61:0
62	Audio/Video Input 62	5002:62:0
63	Audio/Video Input 63	5002:63:0
64	Audio/Video Input 64	5002:64:0
65	Audio Input 65	5002:65:0
66	Audio Input 66	5002:66:0
67	Audio Input 67	5002:67:0
68	Audio Input 68	5002:68:0
69	Audio Input 69	5002:69:0
70	Audio Input 70	5002:70:0
71	Audio Input 71	5002:71:0
72	Audio Input 72	5002:72:0
73	Audio Input 73	5002:73:0
74	Audio Input 74	5002:74:0
75	Audio Input 75	5002:75:0
76	Audio Input 76	5002:76:0
77	Audio Input 77	5002:77:0
78	Audio Input 78	5002:78:0
79	Audio Input 79	5002:79:0
80	Audio Input 80	5002:80:0
81	down-mix Input 81	5002:81:0

Output Port Mapping		
60	Audio/Video Output 60	5002:60:0
61	Audio/Video Output 61	5002:61:0
62	Audio/Video Output 62	5002:62:0
63	Audio/Video Output 63	5002:63:0
64	Audio/Video Output 64	5002:64:0
65	Audio Output 65	5002:65:0
66	Audio Output 66	5002:66:0
67	Audio Output 67	5002:67:0
68	Audio Output 68	5002:68:0
69	Audio Output 69	5002:69:0
70	Audio Output 70	5002:70:0
71	Audio Output 71	5002:71:0
72	Audio Output 72	5002:72:0
73	Audio Output 73	5002:73:0
74	Audio Output 74	5002:74:0
75	Audio Output 75	5002:75:0
76	Audio Output 76	5002:76:0
77	Audio Output 77	5002:77:0
78	Audio Output 78	5002:78:0
79	Audio Output 79	5002:79:0
80	Audio Output 80	5002:80:0

NetLinx Channels and Levels

NetLinx Channels

NetLinx Channels				
Channel	Type	Usage	Ports	Description
Output Audio (Switched Audio Only)				
24	CMD	Pulse, ON/OFF	All A/V & ASB Outputs	Volume Up
25	CMD	Pulse, ON/OFF	All A/V & ASB Outputs	Volume Down
26	CMD	Pulse	All A/V & ASB Outputs	Volume Mute Toggle
199	CMD, FDBK	ON/OFF	All A/V & ASB Outputs	Volume Mute
164	CMD	Pulse, ON/OFF	All A/V & ASB Outputs	Balance Ramp Up
165	CMD	Pulse, ON/OFF	All A/V & ASB Outputs	Balance Ramp Down
DXLink TX VGA Input Video				
83	CMD	Pulse, ON/OFF	DXLink TX VGA Inputs	Video In Phase Up
84	CMD	Pulse, ON/OFF	DXLink TX VGA Inputs	Video In Phase Down
132	CMD	Pulse, ON/OFF	DXLink TX VGA Inputs	Video In V Shift Up
133	CMD	Pulse, ON/OFF	DXLink TX VGA Inputs	Video In V Shift Down
134	CMD	Pulse, ON/OFF	DXLink TX VGA Inputs	Video In H Shift Up
135	CMD	Pulse, ON/OFF	DXLink TX VGA Inputs	Video In H Shift Down
Output Video				
210	CMD, FDBK	ON/OFF	All A/V Outputs	Video Mute
213	CMD, FDBK	ON/OFF	All A/V Outputs	Video Freeze
234	CMD, FDBK	ON/OFF	All A/V Outputs	On-Screen Display (OSD)
System Alarm Status				
216	FDBK	N/A	Responds on 5002:1:0	Fan Alarm Status
217	FDBK	N/A	Responds on 5002:1:0	Temperature Alarm Status
218	FDBK	N/A	Responds on 5002:1:0	Power Alarm Status

NetLinx Levels

NetLinx Levels			
Level	Ports	Range	Function
Input Audio			
5	All A/V & ASB Inputs	-24 to 24	-24 dB to 24 dB
Output Audio (Switched Audio Only)			
1	All A/V & ASB Outputs	0 to 100	Output Volume
2	All A/V & ASB Outputs	-20 to 20	Output Balance
31	All A/V & ASB Outputs	-12 to 12	Audio EQ Band 1
32	All A/V & ASB Outputs	-12 to 12	Audio EQ Band 2
33	All A/V & ASB Outputs	-12 to 12	Audio EQ Band 3
34	All A/V & ASB Outputs	-12 to 12	Audio EQ Band 4
35	All A/V & ASB Outputs	-12 to 12	Audio EQ Band 5
36	All A/V & ASB Outputs	-12 to 12	Audio EQ Band 6
37	All A/V & ASB Outputs	-12 to 12	Audio EQ Band 7
38	All A/V & ASB Outputs	-12 to 12	Audio EQ Band 8
39	All A/V & ASB Outputs	-12 to 12	Audio EQ Band 9
40	All A/V & ASB Outputs	-12 to 12	Audio EQ Band 10
DXLink TX VGA Input Video			
17	DXLink TX VGA Inputs	-50 to 50	Video Input Horizontal Shift
19	DXLink TX VGA Inputs	-10 to 10	Video Input Vertical Shift
Output Video			
20	All A/V Outputs	0 to 100	Video Output Brightness
22	All A/V Outputs	0 to 100	Video Output Contrast
Output Switching Levels			
50	All A/V Outputs	0 to Max Input	Video Switching; Level 50 for each output will be a value from 0 to Highest Video Input Port indicating which video input is switched to that output. Changing the value of this level results in a video switch.
51	All A/V & ASB Outputs	0 to Max Input	Audio Switching; Level 51 for each output will be a value from 0 to Highest Audio Input Port indicating which audio input is switched to that output. Changing the value of this level results in an audio switch.

Digital Media Switchers: SEND_COMMANDs

IMPORTANT: The *SEND_COMMANDs* listed in this section are for the switcher only. For additional information on NetLinx commands used in conjunction with this product, see "WebConsole & Programming Guide – NX-Series Controllers" (available at www.amx.com).

Note the following port information:

- Commands derive their port addressing from the target D:P:S (Device:Port:System).
- To distinguish the functionality of signal input and output ports from the overlapped device port numbers, *the signal input and output numbers are part of the command's action.*
- Video (with/without AIE) input and output ranges:
 - Enova DGX 800: 1-8
 - Enova DGX 1600: 1-16
 - Enova DGX 3200: 1-32
 - Enova DGX 6400: 1-64

NOTE: Because the Audio Insert/Extract Board can be set to insert/extract audio into/out of video inputs or outputs, the audio signals from these boards switch as embedded audio in conjunction with the corresponding video signals.
- Audio Switching Board (ASB and ASB-DAN) input and output ranges**:

NOTE: Audio Switching Board (ASB and ASB-DAN) signal routing is accomplished via *SEND_COMMANDs* (see below), via the System Configuration interface (see page 127), or as embedded audio only via the control panel (see page 246).

 - Enova DGX 800: 1-8 embedded audio, 9-16 audio only
 - Enova DGX 1600: 1-16 embedded audio, 17-24 audio only
 - Enova DGX 3200: 1-32 embedded audio, 33-40 audio only
 - Enova DGX 6400: 1-64 embedded audio, 65-80 audio only

NOTE: For each system, one port is available as an additional input for down-mix. The down-mix port number follows sequentially after the last audio only port (e.g., an Enova DGX 800 Switcher's down-mix port is port number 17).

NOTE: All text is based on a Unicode index.

Switcher SEND_COMMANDS

Switcher SEND_COMMANDS	
Command	Description
AI<input>O<output>	<p>Switches audio input port <input> to audio output port <output>. This command is only available when ASB boards are in the system and correctly installed (HSSI cable connected for Enova DGX 800,1600, and 3200).</p> <p>Note: This command must be sent to D:P:S port 1.</p> <p>Syntax: SEND_COMMAND <DEV>, "AI<input>O<output>"</p> <p>Variables:</p> <ul style="list-style-type: none"> input = The source audio input port number to switch from. output = The destination audio output port number to switch to. <p>Note: For information on Audio Switching Board input and output ports, see the information at the top of this page.</p> <p>Example: SEND_COMMAND 5002:1:0, "AI201,2" Switch audio input port #2 to audio outputs #1 and #2. Any input can be switched to one, many, or all outputs.</p>
?AUTO_SETUP	<p>Requests the current state of the Auto-setup mode.</p> <p>Note: Mode is also visible on the System Configuration interface's Switcher/Status page.</p> <p>Syntax: SEND_COMMAND <DEV>, "?AUTO_SETUP"</p> <p>Examples: SEND_COMMAND 5002:1:0, "?AUTO_SETUP" Returns a response of the form: ON OFF</p>
AUTO_SETUP	<p>Enables or Disables Auto-setup mode. Command affects system-wide Auto-setup ON OFF settings.</p> <p>Note: Mode can also be set via the System Configuration interface's Switcher/Status page.</p> <p>Syntax: SEND_COMMAND <DEV>, "AUTO_SETUP-<ON OFF>"</p> <p>Variables:</p> <ul style="list-style-type: none"> ON (default) = Enables Auto-setup so connected endpoints with default factory settings will automatically be bound to the DGX Master and given specific Private IP addresses and device numbers based on their channel number (see "Automatic Configuration of AMX Devices via ICS LAN" on page 17) OFF = Disables Auto-setup so connected endpoints will revert to traditional NDP/DHCP binding <p>Examples: SEND_COMMAND 5002:1:0, "AUTO_SETUP-OFF"</p>
CI<input>O<output>	<p>Switches both the audio and video input port to the output port.</p> <p>Note: This command must be sent to D:P:S port 1.</p> <p>Syntax: SEND_COMMAND <DEV>, "CI<input>O<output>"</p> <p>Variables:</p> <ul style="list-style-type: none"> input = The source input port number to switch from. output = The destination output port number to switch to. <p>Examples: SEND_COMMAND 5002:1:0, "CI201" Switch (audio/video) input port #2 to output #1. SEND_COMMAND 5002:1:0, "CI301,2" Switch (audio/video) input port #3 to outputs #1 and #2. SEND_COMMAND 5002:1:0, "CI001,2,3" Disconnects output ports #1, #2, and #3.</p>
CL<L#>I<I#>O<O#>	<p>Syntax: SEND_COMMAND <DEV>, "CL<Switch Level>I<Input>O<Outputs>"</p> <p>Variables:</p> <ul style="list-style-type: none"> switch level = ALL, VIDEO, AUDIO input = The source input port number to switch from. (Input of "0" acts as a disconnect for the routed Output(s)) output = The destination output port number to switch to.
?EXT_AUD	<p>Requests the functional status of the Audio Switching Boards.</p> <p>Returns TRUE only when the ASB cards are all inserted properly and the HSSI cable is attached (as directed for 800/1600/3200 systems).</p> <p>Note: This command does not apply to AIE Boards.</p> <p>Syntax: SEND_COMMAND <DEV>, "?EXT_AUD"</p> <p>Example: SEND_COMMAND 5002:1:0, "?EXT_AUD" Returns a response of the form: TRUE FALSE</p>

Switcher SEND_COMMANDs (Cont.)	
Command	Description
?FAN_ALARM	Requests the Fan Alarm State of the Switcher. The fan alarm is triggered by one or more slow or stopped fan unit. Syntax: SEND_COMMAND <DEV>, "'?FAN_ALARM'" Example: SEND_COMMAND 5002:1:0, "'?FAN_ALARM'" Returns a response of the form: ON OFF
?FAN_SPEED	Requests the speed of the fans inside the Enova DGX Switcher. Syntax: SEND_COMMAND <DEV>, "'?FAN_SPEED-<Fan>'" Variable: Fan = Fan is an optional command, to query a specific fan Examples: SEND_COMMAND 5002:1:0, "'?FAN_SPEED'" Returns a COMMAND string of the form: FAN_SPEED- [<Fan1>, <Fan2>, .. <FanN>] SEND_COMMAND 5002:1:0, "'?FAN_SPEED-1'" Returns a COMMAND string of the form: FAN_SPEED-1, <Fan1>
?FG	Requests the Switcher's FG Number. Syntax: SEND_COMMAND <DEV>, "'?FG'" Example: SEND_COMMAND 5002:1:0, "'?FG'"
?IFCONFIG	Requests interface configuration settings. All changes to IP settings require a system reboot to take effect. Syntax: SEND_COMMAND <DEV>, "'?IFCONFIG-1'" Example: SEND_COMMAND 5002:1:0, "'?IFCONFIG-1'" Returns a COMMAND string of the form: SEND_COMMAND 5002:1:0, "'IFCONFIG-1,UP,S,ip=10.35.91.228,gw=10.35.90.1,mask=255.255.255.0,hn=mydgx'"
IFCONFIG	Allows a User to setup a secondary Public Ethernet interface on the Enova DGX Switcher. All changes to DHCP settings require a system reboot to take effect. Syntax: SEND_COMMAND <DEV>, "'IFCONFIG-1,<enablement>,<mode>,<IP Address>,<Gateway>,<Netmask>,<Hostname>'" Variables: <ul style="list-style-type: none"> • Enablement = UP or DOWN • Mode = D (DHCP) or S (Static) • IP Address = Valid IP Address • Gateway = Valid Gateway Address • Netmask = Valid Netmask • Hostname = 32 Character String Note: The gateway, IP address, and netmask variables are only needed for Static IP addresses. Examples: SEND_COMMAND 5002:1:0, "'IFCONFIG-1,UP,S,ip=10.35.90.228,gw=10.35.90.1,mask=255.255.255.0,hn=mydgx'" Enables Static IP Address. SEND_COMMAND 5002:1:0, "'IFCONFIG-1,UP,D'" Enables Dynamic IP Address. SEND_COMMAND 5002:1:0, "'IFCONFIG-1,DOWN'" Disables IP connection.
?INPUT	Requests the input connected to an output. Normally, if the output port is not connected to any input port then the reply will indicate this with an input port number of ZERO (0). Think of the command as asking, "Which audio input port is connected to output port #1?" Syntax: SEND_COMMAND <DEV>, "'?INPUT-<Switch Level>,<Output>'" Variables: <ul style="list-style-type: none"> • Switch Level = AUDIO or VIDEO. • Output = The output port number. Example: SEND_COMMAND 5002:1:0, "'?INPUT-AUDIO,1'" Returns a COMMAND string of the form: SWITCH-L<AUDIO VIDEO>I<Input>O<Output>

Switcher SEND_COMMANDs (Cont.)	
Command	Description
?MODEL	Requests the Switcher's model type. Syntax: SEND_COMMAND <DEV>, "'?MODEL'" Example: SEND_COMMAND 5002:1:0, "'?MODEL'" Returns a COMMAND string of the form: MODEL-<type> types = AMX Enova DGX 800, AMX Enova DGX 1600, AMX Enova DGX 3200, AMX Enova DGX 6400
?OUTPUT	Requests the output(s) connected to an input. Normally, if the output port is not connected to any input port then the reply will indicate this with an output port number of ZERO (0). Think of the command as asking, "Which video output port is connected to input port #1?" Syntax: SEND_COMMAND <DEV>, "'?OUTPUT-<Switch Level>,<Input>'" Variables: • Switch Level = AUDIO or VIDEO or ALL (both Audio and Video). • Input = The source input port number. Example: SEND_COMMAND 5002:1:0, "'?OUTPUT-VIDEO,1'" Returns a COMMAND string of the form: SWITCH-L<AUDIO VIDEO>I<Input>O<Output>
?POWER_ALARM	Requests the Power Alarm State of the Switcher. <i>Note: The power alarm is triggered by a lack of power to any of the internal cards, any input or output card, or any of the power supplies.</i> Syntax: SEND_COMMAND <DEV>, "'?POWER_ALARM'" Example: SEND_COMMAND 5002:1:0, "'?POWER_ALARM'" Returns a response of the form: ON OFF
REBOOT	Reboots the Switcher. Syntax: SEND_COMMAND <DEV>, "'REBOOT'" Example: SEND_COMMAND 5002:1:0, "'REBOOT'" Results in the Switcher rebooting.
?TEMP	Requests the temperature detected inside the Switcher. Temperature values are returned in Celsius. Syntax: SEND_COMMAND <DEV>, "'?TEMP'" Example: SEND_COMMAND 5002:1:0, "'?TEMP'" Returns a COMMAND string of the form: TEMP-<temperature value in degrees Celsius>.
?TEMP_ALARM	Requests the Temperature Alarm State of the Switcher. The temperature alarm is triggered by heat sensors on both center boards and Input and Output boards. Syntax: SEND_COMMAND <DEV>, "'?TEMP_ALARM'" Example: SEND_COMMAND 5002:1:0, "'?TEMP_ALARM'" Returns a response of the form: ON OFF
VI<input>O<output>	Switch input to one or more outputs for switcher level Video. This command <u>must</u> be sent to D:P:S port 1. <i>Note: Set <input> to 0 for disconnect.</i> Syntax: SEND_COMMAND <DEV>, "'VI<input>O<output>'" Variables: • input = The source video input port number to switch from • output = The destination video output port number to switch to Example: SEND_COMMAND 5002:1:0, "'VI201'" Switch video input port #2 to video output #1. SEND_COMMAND 5002:1:0, "'VI301,2'" Switch video input port #3 to video output ports #1 and #2.

Standard Input/Output Boards: SEND_COMMANDS

IMPORTANT: The `SEND_COMMANDS` listed in this section are for standard Input and Output Boards only (HDMI, DVI, DXLink Twisted Pair, DXLink Twisted Pair 4K, and DXLink Fiber). `SEND_COMMANDS` for Audio Switching Boards (ASB and ASB-DAN) are covered on page 225. For additional information on NetLinx commands used in conjunction with this product, see the "WebConsole & Programming Guide – NX-Series Controllers" (available at www.amx.com).

Variables for I# and O#

The **I#** (input port number) and **O#** (output port number) variables in the following table depend on the input and output ranges. Standard board (with/without audio from audio boards) input and output ranges are:

- Enova DGX 800: 1-8
- Enova DGX 1600: 1-16
- Enova DGX 3200: 1-32
- Enova DGX 6400: 1-64

NOTE: All text is based on a Unicode index.

Standard Input SEND_COMMANDS

Standard Input SEND_COMMANDS	
Command	Description
<code>?AUDIN_DIGITAL</code>	Requests the format of the specified audio port. Syntax: <code>SEND_COMMAND <DEV>, " '?AUDIN_DIGITAL' "</code> Example: <code>SEND_COMMAND AUDIO_INPUT_1, " '?AUDIN_DIGITAL' "</code> Returns a COMMAND string of the form: <code>AUDIN_DIGITAL-<format></code>
<code>AUDIN_DIGITAL</code>	Sets the format of the specified audio port. Syntax: <code>SEND_COMMAND <DEV>, " 'AUDIN_DIGITAL-<format>' "</code> Variable: <ul style="list-style-type: none"> • format = PCM-2CH PCM-8CH DOLBY DIGITAL TRUEHD DTS DTSHD MPEG AAC Example: <code>SEND_COMMAND AUDIO_INPUT_1, " 'AUDIN_DIGITAL-AAC' "</code> Sets the audio format for the audio input port to AAC.
<code>?AUDIN_ENCODING</code>	Requests the Audio input's encoding. Syntax: <code>SEND_COMMAND <DEV>, " '?AUDIN_ENCODING' "</code> Example: <code>SEND_COMMAND AUDIO_INPUT_1, " '?AUDIN_ENCODING' "</code> Returns a COMMAND string of the form: <code>AUDIN_ENCODING-<PCM COMPRESSED HBR></code>
<code>?AUDIN_NAME</code>	Requests the name of the specified input port. Syntax: <code>SEND_COMMAND <DEV>, " '?AUDIN_NAME' "</code> Example: <code>SEND_COMMAND AUDIO_INPUT_1, " '?AUDIN_NAME' "</code> Returns a COMMAND string of the form: <code>AUDIN_NAME-<name></code>
<code>AUDIN_NAME</code>	Sets the name of the specified input port to <name>. The Input name may be changed using either the <code>VIDIN_NAME</code> or <code>AUDIN_NAME</code> command. Both commands are used to change the same name attribute and do not create separate names for video or audio. The <name> length is limited to 31 characters. Specifying a longer name results in truncation to the 31 character length limit. Valid characters are: <ul style="list-style-type: none"> • a-z (lowercase letters) • A-Z (uppercase letters) • 0-9 (numerals) • #, -, =, + (special characters: hash, period, dash, underscore, equal, plus, <space> [space characters at the beginning of a name are truncated]) Syntax: <code>SEND_COMMAND <DEV>, " 'AUDIN_NAME-<name>' "</code> Example: <code>SEND_COMMAND AUDIO_INPUT_1, " 'AUDIN_NAME-MyStereo' "</code> Sets the name of input port #1 to MyStereo. This is used for the On Screen Display feature.

Standard Input SEND_COMMANDs (Cont.)	
Command	Description
?VIDIN_FORMAT	<p>Requests the input format of the video port addressed by the D:P:S.</p> <p>Syntax: SEND_COMMAND <DEV>, "'?VIDIN_FORMAT' "</p> <p>Variable:</p> <ul style="list-style-type: none"> Format = HDMI, DVI, S-VIDEO, COMPONENT, COMPOSITE, VGA (for Multi-Format inputs) <p>Example: SEND_COMMAND VIDEO_INPUT_1, "'?VIDIN_FORMAT' "</p> <p>Returns a COMMAND string of the form: VIDIN_FORMAT-<format></p>
?VIDIN_HDCP	<p>Requests the video input HDCP compliance setting of the specified video input port.</p> <p>Syntax: SEND_COMMAND <DEV>, "'?VIDIN_HDCP' "</p> <p>Example: SEND_COMMAND VIDEO_INPUT_1, "'?VIDIN_HDCP' "</p> <p>Returns a string of the form: VIDIN_STATUS-<ENABLE DISABLE></p>
VIDIN_HDCP	<p>Sets the video input HDCP compliance setting of the specified video input port.</p> <ul style="list-style-type: none"> VIDIN_HDCP commands for Solecis switchers must be sent directly to the Solecis unit, not sent via the 5002 device. When VIDIN_HDCP is disabled, the addressed video input will appear to any source as not being HDCP compliant. <p>For computer sources that encrypt all video when connected to an HDCP compliant display, disabling HDCP compliance on the input will cause the computer to send non-encrypted video which can then be routed to non-compliant displays and video conferencing systems. It may be necessary to disconnect and re-connect PC sources after changing this setting.</p> <p>Note: Disabling HDCP compliance for sources that do not support non-compliant displays (such as DVD and Blu-Ray players) is not recommended and may affect the source's ability to send video.</p> <p>Syntax: SEND_COMMAND <DEV>, "'VIDIN_HDCP-<option>' "</p> <p>Variable: option = ENABLE, DISABLE (default = ENABLE)</p> <p>Example: SEND_COMMAND VIDEO_INPUT_1, "'VIDIN_HDCP-ENABLE' "</p> <p>Enables the HDCP compliance of video input port #1.</p>
?HDCPSTATUS	<p>Request the video input encryption status addressed by the D:P:S</p> <p>Syntax: SEND_COMMAND <DEV>, "'?HDCPSTATUS' "</p> <p>Example: SEND_COMMAND VIDEO_INPUT_1, "'?HDCPSTATUS' "</p> <p>Returns a COMMAND string of the form: HDCPSTATUS-<status string> status string = ENABLE, DISABLE, or ERROR.</p>
?VIDIN_NAME	<p>Requests the input name of the specified video port.</p> <p>Syntax: SEND_COMMAND <DEV>, "'?VIDIN_NAME' "</p> <p>Example: SEND_COMMAND VIDEO_INPUT_1, "'?VIDIN_NAME' "</p> <p>Returns a COMMAND string of the form: VIDIN_NAME-<name></p>
VIDIN_NAME	<p>Sets the name of the specified port to <name>. The Input name may be changed using either the VIDIN_NAME or AUDIN_NAME command. Both commands are used to change the same name attribute and do not create separate names for video or audio.</p> <p>The <name> length is limited to 31 characters. Specifying a longer name will result in truncation to the 31 character length limit. Valid characters are:</p> <ul style="list-style-type: none"> a-z (lower case letters) A-Z (upper case letters) 0-9 (numeric) #,._=+ (special characters hash, period, dash, underscore, equal, plus <space> [space characters at the beginning of a name are truncated]) <p>Syntax: SEND_COMMAND <DEV>, "'VIDIN_NAME-<name>' "</p> <p>Variable:</p> <ul style="list-style-type: none"> name = A string name (e.g., PC 1) <p>Example: SEND_COMMAND VIDEO_INPUT_1, "'VIDIN_NAME-MyPC' "</p> <p>Sets the name of input port (#1 based on D:P:S) to MyPC. This is used for the On Screen Display feature.</p>

Standard Input SEND_COMMANDs (Cont.)	
Command	Description
?VIDIN_PREF_EDID	Requests the preferred resolution of the EDID source being mirrored by the specified video port. Syntax: SEND_COMMAND <DEV>, "'?VIDIN_PREF_EDID' " Example: SEND_COMMAND VIDEO_INPUT_1, "'?VIDIN_PREF_EDID' " Returns a COMMAND string of the form: VIDIN_PREF_EDID-<resolution>
VIDIN_PREF_EDID	Sets the preferred resolution for the EDID source to mirror in the specified video input port. You can only set the preferred resolution if you use the VIDIN_EDID command to set the EDID source to All Resolutions, Wide-screen, Full-screen, or 4K. Syntax: SEND_COMMAND <DEV>, " 'VIDIN_PREF_EDID-<resolution>' " Example: SEND_COMMAND VIDEO_INPUT_1, " 'VIDIN_PREF_EDID-1280x1024,60' "
?VIDIN_RES_REF	Requests the resolution of the video input port addressed by the D:P:S. Syntax: SEND_COMMAND <DEV>, "'?VIDIN_RES_REF' " Example: SEND_COMMAND VIDEO_INPUT_1, "'?VIDIN_RES_REF' " Returns a COMMAND string of the form: VIDIN_RES_REF-<h>x<v>,<rate>
?VIDIN_STATUS	Requests the video input status of the video input port addressed by the D:P:S Syntax: SEND_COMMAND <DEV>, "'?VIDIN_STATUS' " Example: SEND_COMMAND VIDEO_INPUT_1, "'?VIDIN_STATUS' " Returns a COMMAND string of the form: VIDIN_STATUS-<status string> status string = NO SIGNAL, UNKNOWN SIGNAL, UNSUPPORTED or VALID SIGNAL.

Standard Output SEND_COMMANDs

Standard Output SEND_COMMANDs	
Command	Description
?AUDOUT_ENCODING	Requests the audio output's encoding. Syntax: SEND_COMMAND <DEV>, "'?AUDOUT_ENCODING' " Example: SEND_COMMAND AUDIO_OUTPUT_1, "'?AUDOUT_ENCODING' " Returns a COMMAND string of the form: AUDOUT_ENCODING-<PCM COMPRESSED HBR>
?AUDOUT_NAME	Requests the name of the specified output port. Syntax: SEND_COMMAND <DEV>, "'?AUDOUT_NAME' " Example: SEND_COMMAND AUDIO_OUTPUT_1, "'?AUDOUT_NAME' " Returns a COMMAND string of the form: AUDOUT_NAME-<name>
AUDOUT_NAME	Sets the name of the specified output port to <name>. The Output name may be changed using either the VIDOUT_NAME or AUDOUT_NAME command. Both commands are used to change the same name attribute and do not create separate names for video or audio. The <name> length is limited to 31 characters. Specifying a longer name results in truncation to the 31 character length limit. Valid characters are: <ul style="list-style-type: none"> • a-z (lowercase letters) • A-Z (uppercase letters) • 0-9 (numerals) • #, ., =, + (special characters: hash, period, dash, underscore, equal, plus, <space> [space characters at the beginning of a name are truncated]) Syntax: SEND_COMMAND <DEV>, " 'AUDOUT_NAME-<name>' " Example: SEND_COMMAND AUDIO_OUTPUT_1, " 'AUDOUT_NAME-MyStereo' " Sets the name of the Output port to MyStereo. This is used for the On Screen Display feature.

Standard Output SEND_COMMANDs (Cont.)	
Command	Description
?VIDOUT_ASPECT_RATIO	Requests the aspect ratio of the video output port addressed by the D:P:S. Syntax: SEND_COMMAND <DEV>, "'?VIDOUT_ASPECT_RATIO' " Example: SEND_COMMAND VIDEO_OUTPUT_1, "'?VIDOUT_ASPECT_RATIO' " Returns a COMMAND string of the form: VIDOUT_ASPECT_RATIO-<ratio> Note: See the VIDOUT_ASPECT_RATIO command for the list of aspect ratios.
VIDOUT_ASPECT_RATIO	Sets the aspect ratio of the video output port addressed by the D:P:S. The <ratio> value is case sensitive. Syntax: SEND_COMMAND <DEV>, "'VIDOUT_ASPECT_RATIO-<ratio>' " Variable: • ratio = MAINTAIN, STRETCH, ZOOM, ANAMORPHIC (dependent on board type) Note: This command also accepts FULL in place of MAINTAIN. Example: SEND_COMMAND VIDEO_OUTPUT_1, "'VIDOUT_ASPECT_RATIO-ZOOM' " Sets the output port's aspect ratio to zoom.
?VIDOUT_BLANK	Requests the image setting of the video blanking feature on the video port addressed by the D:P:S. Syntax: SEND_COMMAND <DEV>, "'?VIDOUT_BLANK' " Example: SEND_COMMAND VIDEO_OUTPUT_1, "'?VIDOUT_BLANK' " Returns a COMMAND string of the form: VIDOUT_BLANK-<image> Note: See the VIDOUT_BLANK command for the list of images.
VIDOUT_BLANK	Sets the image of the video blanking feature for the video output port addressed by the D:P:S. Syntax: SEND_COMMAND <DEV>, "'VIDOUT_BLANK-<image>' " Variable: • image = black, blue Example: SEND_COMMAND VIDEO_OUTPUT_1, "'VIDOUT_BLANK' "
VIDOUT_BLOCKED	Provides details about the reason a route is indicated as VIDOUT_STATUS-UNSUPPORTED. Syntax: SEND_COMMAND <DEV>, "'VIDOUT_BLOCKED>' " Example: SEND_COMMAND VIDEO_OUTPUT_1, "'VIDOUT_BLOCKED' " Returns a COMMAND string of the form: VIDOUT_BLOCKED-NONE LEAF SWITCHER • NONE: pre-qualification permits the signal to pass • LEAF: the routed signal cannot be displayed on the connected sink • SWITCHER: output chain downstream of the distribution matrix does not support the routed signal Note: This command is a query command and is also sent asynchronously.
?VIDOUT_BRIGHTNESS	Requests the output brightness of the video port addressed by the D:P:S. Syntax: SEND_COMMAND <DEV>, "'?VIDOUT_BRIGHTNESS' " Example: SEND_COMMAND VIDEO_OUTPUT_1, "'?VIDOUT_BRIGHTNESS' " Returns a COMMAND string of the form: VIDOUT_BRIGHTNESS-<value>
VIDOUT_BRIGHTNESS	Sets the output brightness of the video port addressed by the D:P:S to <value>. Syntax: SEND_COMMAND <DEV>, "'VIDOUT_BRIGHTNESS-<value>' " Variable: • Value = 0 to 100 Example: SEND_COMMAND VIDEO_OUTPUT_1, "'VIDOUT_BRIGHTNESS-50' " Sets the brightness of video output port (#1 based on D:P:S) to 50.
?VIDOUT_CABLE_CONNECTED	Determines if a Video Display is connected to a Video Output Port. Syntax: SEND_COMMAND <DEV>, "'?VIDOUT_CABLE_CONNECTED' " Example: SEND_COMMAND VIDEO_INPUT_1, "'?VIDOUT_CABLE_CONNECTED' " Returns a COMMAND string of the form: VIDOUT_CABLE_CONNECTED-<CONNECTED DISCONNECTED>

Standard Output SEND_COMMANDs (Cont.)	
Command	Description
?VIDOUT_MUTE	Requests to see if video mute is enabled or disabled. Syntax: SEND_COMMAND <DEV> , " ' ?VIDOUT_MUTE ' " Example: SEND_COMMAND VIDEO_OUTPUT_3 , " ' ?VIDOUT_MUTE ' " Returns a COMMAND string of the form: VIDOUT_MUTE<ENABLE DISABLE>
VIDOUT_MUTE	Enables or disables video mute. Syntax: SEND_COMMAND <DEV> , " ' VIDOUT_MUTE-<ENABLE DISABLE>' " Example: SEND_COMMAND VIDEO_OUTPUT_6 , " ' VIDOUT_MUTE-ENABLE ' "
?VIDOUT_NAME	Requests the input name of the specified video port. Syntax: SEND_COMMAND <DEV> , " ' ?VIDOUT_NAME ' " Example: SEND_COMMAND VIDEO_OUTPUT_1 , " ' ?VIDOUT_NAME ' " Returns a COMMAND string of the form: VIDOUT_NAME-<name>
VIDOUT_NAME	Sets the input name of the specified video port to <name>. <ul style="list-style-type: none"> The Output name may be changed using either the VIDOUT_NAME or AUDOUT_NAME command. Both commands are used to change the same name attribute and do not create separate names for video or audio. The <name> length is limited to 31 characters. Specifying a longer name will result in truncation to the 31 character length limit. Valid characters are: <ul style="list-style-type: none"> a-z (lower case letters) A-Z (upper case letters) 0-9 (numeric) #.-_+= (special characters hash, period, dash, underscore, equal, plus <space> [space characters at the beginning of a name are truncated]) Syntax: SEND_COMMAND <DEV> , " ' VIDOUT_NAME-<name>' " Variable: <ul style="list-style-type: none"> name = A string name. e.g.: "Monitor 1" Example: SEND_COMMAND VIDEO_OUTPUT_1 , " ' VIDOUT_NAME-MyMonitor' " Sets the name of Output port #1 to MyMonitor. <i>Note: This is used for the On Screen Display feature.</i>
?VIDOUT_OSD	Requests whether the video port addressed by the D:P:S has the OSD setting enabled or disabled. Syntax: SEND_COMMAND <DEV> , " ' ?VIDOUT_OSD ' " Example: SEND_COMMAND VIDEO_OUTPUT_1 , " ' ?VIDOUT_OSD ' " Returns a COMMAND string of the form: VIDOUT_OSD-<ENABLE DISABLE>
VIDOUT_OSD	Enables or Disables the On Screen Display (OSD) setting on the video port addressed by the D:P:S. If enabled, then the OSD setting is on. If disabled, then the OSD setting is off. Syntax: SEND_COMMAND <DEV> , " ' VIDOUT_OSD-<ENABLE DISABLE>' " Example: SEND_COMMAND VIDEO_OUTPUT_1 , " ' VIDOUT_OSD-ENABLE ' "
?VIDOUT_OSD_COLOR	Requests the On Screen Display (OSD) color on the display connected to the video port addressed by the D:P:S. Syntax: SEND_COMMAND <DEV> , " ' ?VIDOUT_OSD_COLOR ' " Example: SEND_COMMAND VIDEO_OUTPUT_1 , " ' ?VIDOUT_OSD_COLOR ' " Returns a COMMAND string of the form: VIDOUT_OSD_COLOR-<color>

Standard Output SEND_COMMANDs (Cont.)																
Command	Description															
VIDOUT_OSD_COLOR	<p>Determines the On Screen Display (OSD) color scheme on the display connected to the video port addressed by the D:P:S. Color option settings for OSD are combinations of a background color with a contrasting font color.</p> <p>Syntax: SEND_COMMAND <DEV>, " 'VIDOUT_OSD_COLOR-<color>' "</p> <p>Variables:</p> <ul style="list-style-type: none"> • color = black, blue, white, yellow <p>Schemes:</p> <table border="1"> <thead> <tr> <th>Options</th> <th>Background</th> <th>Font</th> </tr> </thead> <tbody> <tr> <td>Black</td> <td>Black</td> <td>White</td> </tr> <tr> <td>Blue</td> <td>Blue</td> <td>Yellow</td> </tr> <tr> <td>White</td> <td>White</td> <td>Black</td> </tr> <tr> <td>Yellow</td> <td>Yellow</td> <td>Blue</td> </tr> </tbody> </table> <p>Example: SEND_COMMAND VIDEO_OUTPUT_1, " 'VIDOUT_OSD_COLOR-BLACK' "</p>	Options	Background	Font	Black	Black	White	Blue	Blue	Yellow	White	White	Black	Yellow	Yellow	Blue
Options	Background	Font														
Black	Black	White														
Blue	Blue	Yellow														
White	White	Black														
Yellow	Yellow	Blue														
?VIDOUT_OSD_POS	<p>Requests the On Screen Display (OSD) position on the display connected to the video port addressed by the D:P:S.</p> <p>Syntax: SEND_COMMAND <DEV>, " '?VIDOUT_OSD_POS' "</p> <p>Example: SEND_COMMAND VIDEO_OUTPUT_1, " '?VIDOUT_OSD_POS' "</p> <p>Returns a COMMAND string of the form: VIDOUT_OSD_POS-<position></p>															
VIDOUT_OSD_POS	<p>Determines the On Screen Display (OSD) position on the display connected to the video port addressed by the D:P:S.</p> <p>Syntax: SEND_COMMAND <DEV>, " 'VIDOUT_OSD_POS-<position>' "</p> <p>Variable:</p> <ul style="list-style-type: none"> • position = TOP LEFT, TOP RIGHT, BTM RIGHT, BTM LEFT <p>Example: SEND_COMMAND VIDEO_OUTPUT_1, " 'VIDOUT_OSD_POS-TOP LEFT' "</p>															
?VIDOUT_RES_REF	<p>Requests the resolution and refresh rate of the video output port addressed by the D:P:S.</p> <p>Syntax: SEND_COMMAND <DEV>, " '?VIDOUT_RES_REF' "</p> <p>Example: SEND_COMMAND VIDEO_OUTPUT_1, " '?VIDOUT_RES_REF' "</p> <p>Returns a COMMAND string of the form: VIDOUT_RES_REF-<h>x<v>, <rate></p>															
VIDOUT_RES_REF	<p>Sets the resolution and refresh rate of the video output port addressed by D:P:S. Invalid combinations are ignored by the All-In-One Presentation Switcher.</p> <p>Syntax: SEND_COMMAND <DEV>, " 'VIDOUT_RES_REF-<horizontal>x<vertical>, <refresh-rate>' "</p> <p>Variables:</p> <ul style="list-style-type: none"> • Horizontal = Integer value representing the horizontal. • Vertical = Integer value representing the vertical. (May have an additional qualifier such as 'i' or 'p') • Refresh-rate = Integer value representing the refresh rate. <p>Example: SEND_COMMAND VIDEO_OUTPUT_1, " 'VIDOUT_RES_REF-1280x1024, 60' "</p>															
?VIDOUT_SCALE	<p>Requests to see which scaling mode the video output port addressed by the D:P:S.</p> <p>Syntax: SEND_COMMAND <DEV>, " '?VIDOUT_SCALE' "</p> <p>Example: SEND_COMMAND VIDEO_OUTPUT_1, " '?VIDOUT_SCALE' "</p> <p>Returns a COMMAND string of the form: VIDOUT_SCALE-<scale></p>															
VIDOUT_SCALE	<p>Sets the scaling mode for the video output port addressed by D:P:S.</p> <p>Syntax: SEND_COMMAND <DEV>, " 'VIDOUT_SCALE-<scale>' "</p> <p>Variable:</p> <ul style="list-style-type: none"> • scale = Auto, Manual, or Bypass <p>Example: SEND_COMMAND VIDEO_OUTPUT_1, " 'VIDOUT_SCALE-AUTO' "</p>															

Standard Output SEND_COMMANDs (Cont.)	
Command	Description
?VIDOUT_SLEEP	Requests whether a Video Output port turns off TMDS lines. Syntax: SEND_COMMAND <DEV>, "'?VIDOUT_SLEEP' " Example: SEND_COMMAND 5002:1:11, "'?VIDOUT_SLEEP' " Returns a COMMAND string of the form: VIDOUT_SLEEP-ENABLE
VIDOUT_SLEEP	Sets if a Video Output port turns off TMDS lines. While most monitors handle the sleep function well, some monitors continually attempt to wake up, resulting in constant or intermittent screen blanking when no video is present. For the video output attached to the problematic monitor, either uncheck the Allow Display Sleep option and set the Blank Color in the System Configuration interface (see page 127) or set VIDOUT_SLEEP-DISABLE and VIDOUT_BLANK-<color>. Syntax: SEND_COMMAND <DEV>, "'VIDOUT_SLEEP-<ENABLE DISABLE>' " Example: SEND_COMMAND 5002:1:1, "'VIDOUT_SLEEP-ENABLE' "
?VIDOUT_SLEEP_DELAY	Requests the amount of seconds the blanking color is displayed before the TMDS lines turn off. Syntax: SEND_COMMAND <DEV>, "'?VIDOUT_SLEEP_DELAY' " Example: SEND_COMMAND 5002:1:11, "'?VIDOUT_SLEEP_DELAY' " Returns a COMMAND string of the form: VIDOUT_SLEEP_DELAY-600
VIDOUT_SLEEP_DELAY	Sets the amount of seconds the blanking color is displayed before the TMDS lines turn off. Syntax: SEND_COMMAND <DEV>, "'VIDOUT_SLEEP_DELAY-<time>' " Variable: • time: 1-32737 (in seconds) Example: SEND_COMMAND 5002:1:11, "'VIDOUT_SLEEP_DELAY-600' "
?VIDOUT_STATUS	Requests the video status of the video output port addressed by the D:P:S. Syntax: SEND_COMMAND <DEV>, "'?VIDOUT_STATUS' " Example: SEND_COMMAND VIDEO_INPUT_1, "'?VIDOUT_STATUS' " Returns a COMMAND string of the form: VIDOUT_STATUS-<NO SIGNAL UNKNOWN SIGNAL UNSUPPORTED VALID SIGNAL> Note: "UNSUPPORTED" indicates that there exists a desired route in the system but the Enova DGX 100 Series system video path, excluding 3rd party equipment, is unable to pass the video format from end to end as requested.
?VIDOUT_TESTPAT	Requests the test pattern setting. Syntax: SEND_COMMAND <DEV>, "'?VIDOUT_TESTPAT' " Example: SEND_COMMAND VIDEO_OUTPUT_1, "'?VIDOUT_TESTPAT' " Returns a COMMAND string of the form: VIDOUT_TESTPAT-<pattern> See the VIDOUT_TESTPAT command for the list of test patterns.
VIDOUT_TESTPAT	Sets the test pattern to display. Syntax: SEND_COMMAND <DEV>, "'VIDOUT_TESTPAT-<pattern>' " Variable: • pattern = Off, Color Bar, Gray Ramp, SMPTE Bar, HiLoTrak, Plug, X-Hatch (These options are not case sensitive.) Example: SEND_COMMAND VIDEO_OUTPUT_1, "'VIDOUT_TESTPAT-X-Hatch' " Sets the test pattern to display to "X-Hatch."

DXLink Input and Output Boards: SEND_COMMANDS

NOTE: This section only applies to DXLink Twisted Pair, DXLink Twisted Pair 4K, and DXLink Fiber Input and Output Boards.

DXLink SEND_COMMANDS	
Command	Description
?AUDIN_FORMAT	Requests the input format of the audio port addressed by the D:P:S. Syntax: SEND_COMMAND <DEV>, "'?AUDIN_FORMAT' " Example: SEND_COMMAND AUDIO_INPUT_1, "'?AUDIN_FORMAT' " Returns a COMMAND string of the form: AUDIN_FORMAT-<HDMI SPDIF ANALOG>
AUDIN_FORMAT	Sets the input format of the audio port addressed by the D:P:S to HDMI, SPDIF, or ANALOG. Syntax: SEND_COMMAND <DEV>, "'AUDIN_FORMAT-<format>' " Variable: • format = HDMI, SPDIF, ANALOG Example: SEND_COMMAND VIDEO_INPUT_1, "'AUDIN_FORMAT-<HDMI>' " Sets the format of audio input port (#1 based on D:P:S) to HDMI.
?AUDIN_FORMAT_AUTO	Requests the format setting of an audio input port. Syntax: SEND_COMMAND <DEV>, "'?AUDIN_FORMAT_AUTO' " Example: SEND_COMMAND VIDEO_INPUT_1, "'?AUDIN_FORMAT_AUTO' " Returns a COMMAND string of the form: AUDIN_FORMAT_AUTO-<ENABLE DISABLE>
AUDIN_FORMAT_AUTO	Enables or disables the audio input port addressed by the D:P:S. Syntax: SEND_COMMAND <DEV>, "'AUDIN_FORMAT_AUTO-<setting>' " Variable: • setting = ENABLE or DISABLE Example: SEND_COMMAND VIDEO_INPUT_1, "'AUDIN_FORMAT_AUTO-ENABLE' "
?AUDOUT_FORMAT	Requests the output format of the audio port addressed by the D:P:S. Syntax: SEND_COMMAND <DEV>, "'?AUDOUT_FORMAT' " Example: SEND_COMMAND AUDIO_OUTPUT_1, "'?AUDOUT_FORMAT' " Returns a COMMAND string of the form: AUDOUT_FORMAT-<format>
AUDOUT_FORMAT	Sets the output format of the audio port addressed by the D:P:S. Syntax: SEND_COMMAND <DEV>, "'AUDOUT_FORMAT-<format>' " Variable: • format = HDMI, Analog, All Example: SEND_COMMAND VIDEO_OUTPUT_1, "'AUDOUT_FORMAT-<HDMI>' " Sets the format of audio output port (#1 based on D:P:S) to HDMI.
?DXLINKIN_LINK_STATUS	Requests if an Endpoint is connected to the Input Board. Syntax: SEND_COMMAND <DEV>, "'?DXLINKIN_LINK_STATUS' " Example: SEND_COMMAND INPUT_1, "'?DXLINKIN_LINK_STATUS' " Returns a COMMAND string of the form: DXLINKIN_LINK_STATUS-<DISCONNECTED CONNECTED>
?DXLINKOUT_LINK_STATUS	Requests if an Endpoint is connected to the Output Board. Syntax: SEND_COMMAND <DEV>, "'?DXLINKOUT_LINK_STATUS' " Example: SEND_COMMAND OUTPUT_1, "'?DXLINKOUT_LINK_STATUS' " Returns a COMMAND string of the form: DXLINKOUT_LINK_STATUS-<DISCONNECTED CONNECTED>

DXLink SEND_COMMANDS (Cont.)	
Command	Description
?DXLINKIN_QUALITY	Requests a value that represents the quality of the signal between an Input Port and an Endpoint. Syntax: SEND_COMMAND <DEV>, "'?DXLINKIN_QUALITY'" Example: SEND_COMMAND INPUT_1, "'?DXLINKIN_QUALITY'" Returns a COMMAND string of the form: DXLINKIN_QUALITY--22
?DXLINKOUT_QUALITY	Requests a value that represents the quality of the signal between an Output Port and an Endpoint. Syntax: SEND_COMMAND <DEV>, "'?DXLINKOUT_QUALITY'" Example: SEND_COMMAND OUTPUT_1, "'?DXLINKOUT_QUALITY'" Returns a COMMAND string of the form: DXLINKOUT_QUALITY--22
?DXLINKIN_QUALITY_ALARM	Alarm is triggered when cable quality is beyond the threshold where overall performance issues are likely to occur. Syntax: SEND_COMMAND <DEV>, "'?DXLINKIN_QUALITY_ALARM'" Example: SEND_COMMAND INPUT_1, "'?DXLINKIN_QUALITY_ALARM'" Returns a COMMAND string of the form: DXLINKIN_QUALITY_ALARM-OFF or DXLINKIN_QUALITY_ALARM-ON
?DXLINKOUT_QUALITY_ALARM	Alarm is triggered when cable quality is beyond the threshold where overall performance issues are likely to occur. Syntax: SEND_COMMAND <DEV>, "'?DXLINKOUT_QUALITY_ALARM'" Example: SEND_COMMAND OUTPUT_1, "'?DXLINKOUT_QUALITY_ALARM'" Returns a COMMAND string of the form: DXLINKOUT_QUALITY_ALARM-OFF or DXLINKOUT_QUALITY_ALARM-ON
?VIDIN_AUTO_SELECT	Requests setting for the Auto Select mode for the input signal addressed by the D:P:S. VIDIN_AUTO commands for Solecis Switchers must be sent directly to the Solecis unit, not sent via the 5002 device. Syntax: SEND_COMMAND <dev>, "'?VIDIN_AUTO_SELECT'" Example: SEND_COMMAND <5002:1:1>, "'?VIDIN_AUTO_SELECT'" Returns a COMMAND string of the form: VIDIN_AUTO_SELECT-<ENABLE DISABLE>
VIDIN_AUTO_SELECT	Enables or disables the Auto Select mode for the input signal addressed by the D:P:S. VIDIN_AUTO commands for Solecis Switchers must be sent directly to the Solecis unit, not sent via the 5002 device. Syntax: SEND_COMMAND <dev>, "'VIDIN_AUTO_SELECT-<setting>'" Variable: • Setting = ENABLE or DISABLE Example: SEND_COMMAND <5002:1:1>, "'?VIDIN_AUTO_SELECT-ENABLE'"
?VIDIN_HSHIFT	Requests the input horizontal shift of the specified VGA video port. Syntax: SEND_COMMAND <DEV>, "'?VIDIN_HSHIFT'" Example: SEND_COMMAND VIDEO_INPUT_1, "'?VIDIN_HSHIFT'" Returns a COMMAND string of the form: VIDIN_HSHIFT-<value>
VIDIN_HSHIFT	Sets the horizontal shift of the specified video port to <value>. Syntax: SEND_COMMAND <DEV>, "'VIDIN_HSHIFT-<value>'" Variable: • value = -50 to 50 Example: SEND_COMMAND <DEV>, "'VIDIN_HSHIFT-2'" Sets the Horizontal shifting of VGA video input port (#1 based on D:P:S) to 2 (shift to right). SEND_COMMAND VIDEO_INPUT_1, "'VIDIN_HSHIFT--3'" Sets the horizontal shifting of VGA video input port (#1 based on D:P:S) to -3 (shift to left).

DXLink SEND_COMMANDs (Cont.)	
Command	Description
?VIDIN_PHASE	<p>Requests the input phase of the specified VGA video port. This command is valid only for inputs whose format is set to VGA.</p> <p>Syntax: SEND_COMMAND <DEV> , " ' ?VIDIN_PHASE ' "</p> <p>Example: SEND_COMMAND VIDEO_INPUT_1 , " ' ?VIDIN_PHASE ' "</p> <p>Returns a COMMAND string of the form: VIDIN_PHASE-<value></p>
VIDIN_PHASE	<p>Sets the input phase of the specified VGA video port. This command is valid only for inputs whose format is set to VGA.</p> <p>Syntax: SEND_COMMAND <DEV> , " ' VIDIN_PHASE-<value> ' "</p> <p>Variable:</p> <ul style="list-style-type: none"> • value = 0 to 31 <p>Example: SEND_COMMAND VIDEO_INPUT_1 , " ' VIDIN_PHASE-23 ' "</p> <p>Sets the phase of video input port (#1 based on D:P:S) to 23.</p>
?VIDIN_VSHIFT	<p>Requests the vertical shift value of the specified RGB video input port.</p> <p>Syntax: SEND_COMMAND <DEV> , " ' ?VIDIN_VSHIFT ' "</p> <p>Example: SEND_COMMAND VIDEO_INPUT_1 , " ' ?VIDIN_VSHIFT ' "</p> <p>Returns a COMMAND string of the form: VIDIN_VSHIFT-<value></p>
VIDIN_VSHIFT	<p>Sets the vertical shift of the video port addressed by the D:P:S to <value>.</p> <p>Syntax: SEND_COMMAND <DEV> , " ' VIDIN_VSHIFT-<value> ' "</p> <p>Variable:</p> <ul style="list-style-type: none"> • value = -10 to 10 <p>Example: SEND_COMMAND <DEV> , " ' VIDIN_VSHIFT-2 ' "</p> <p>Sets the vertical shift of RGB video input port (#1 based on D:P:S) to 2 (shift upward).</p> <p>SEND_COMMAND VIDEO_INPUT_1 , " ' VIDIN_VSHIFT--3 ' "</p> <p>Sets the vertical shift of RGB video input port (#1 based on D:P:S) to -3 (shift downward).</p>

Audio Switching Boards: SEND_COMMANDS

IMPORTANT: The `SEND_COMMANDS` listed in this section apply to all inputs and outputs when Audio Switching Boards (ASB and ASB-DAN) are installed. The output must be in `SWITCHED` audio mode for these commands to function. For additional information on NetLinx commands used in conjunction with this product, see the "WebConsole & Programming Guide - NX-Series Controllers" (available at www.amx.com).

NOTE: This section *does not apply to Audio Insert/Extract Boards*.

Note the following port information:

- Commands derive their port addressing from the target D:P:S (Device:Port:System).
- ASB Commands can be sent to any input/output, but are only available when Audio Switching Boards are present in the system (and connected via an HSSI connector for Enova DGX 800, 1600, and 3200 systems).
- For each system, one port is available as an additional input for down-mix. The down-mix port number follows sequentially after the last audio only port (e.g., an Enova DGX 800 Switcher's down-mix port is port number 17).

Audio Switching Boards signal routing is accomplished either via `SEND_COMMANDS` (see below) or via the System Configuration interface (see page 127).

NOTE: All text is based on a Unicode index.

Audio Input SEND_COMMANDS	
Command	Description
?AUDIN_COMPRESSION	Requests the compression setting for the audio port addressed by the D:P:S. Syntax: SEND_COMMAND <DEV>, "'?AUDIN_COMPRESSION'" Example: SEND_COMMAND AUDIO_INPUT_1, "'?AUDIN_COMPRESSION'" Returns a COMMAND string of the form: AUDIN_COMPRESSION-<setting> Note: See the <code>AUDIN_COMPRESSION</code> command for the list of settings.
AUDIN_COMPRESSION	Sets the compression for the audio port addressed by the D:P:S. Syntax: SEND_COMMAND <DEV>, "'AUDIN_COMPRESSION-<setting>'" Variable: • setting = off, low, medium, high, custom Example: SEND_COMMAND AUDIO_INPUT_1, "'AUDIN_COMPRESSION-high'" Sets the compression setting of the audio input port #1 to high.
?AUDIN_COMPRESSION_ATTACK	Requests the compression attack for the audio port. Syntax: SEND_COMMAND <DEV>, "'?AUDIN_COMPRESSION_ATTACK'" Example: SEND_COMMAND AUDIO_1, "'?AUDIN_COMPRESSION_ATTACK'" Returns a COMMAND string of the form: AUDIN_COMPRESSION_ATTACK-<attack> Note: See the <code>AUDIN_COMPRESSION_ATTACK</code> command for the attack range.
AUDIN_COMPRESSION_ATTACK	Sets the duration of the attack phase while compressing for the audio port addressed by the D:P:S. Syntax: SEND_COMMAND <DEV>, "'AUDIN_COMPRESSION_ATTACK-<attack>'" Variable: • attack = 1 to 2000 Example: SEND_COMMAND AUDIO_INPUT_1, "'AUDIN_COMPRESSION_ATTACK-200'" Sets the compression attack for the audio port to 200.
?AUDIN_COMPRESSION_RATIO	Requests the compression ratio for the audio port. Syntax: SEND_COMMAND <DEV>, "'?AUDIN_COMPRESSION_RATIO'" Example: SEND_COMMAND AUDIO_INPUT_1, "'?AUDIN_COMPRESSION_RATIO'" Returns a COMMAND string of the form: AUDIN_COMPRESSION_RATIO-<ratio> See the <code>AUDIN_COMPRESSION_RATIO</code> command for the compression ratio range.
AUDIN_COMPRESSION_RATIO	Sets the compression ratio for the audio input port addressed by the D:P:S. Syntax: SEND_COMMAND <DEV>, "'AUDIN_COMPRESSION_RATIO-<ratio>'" Variable: • ratio = 1 to 20 Example: SEND_COMMAND AUDIO_INPUT_1, "'AUDIN_COMPRESSION_RATIO-5'"

Audio Input SEND_COMMANDs (Cont.)	
Command	Description
?AUDIN_COMPRESSION_RELEASE	Requests the compression release for the audio port. Syntax: SEND_COMMAND <DEV>, "'?AUDIN_COMPRESSION_RELEASE'" Example: SEND_COMMAND AUDIO_1, "'?AUDIN_COMPRESSION_RELEASE'" Returns a COMMAND string of the form: AUDIN_COMPRESSION_RELEASE-<release> <i>Note: See the AUDIN_COMPRESSION_RELEASE command for the compression release range.</i>
AUDIN_COMPRESSION_RELEASE	Sets the duration of the release phase while compressing for the audio port addressed by the D:P:S. Syntax: SEND_COMMAND <DEV>, "'AUDIN_COMPRESSION_RELEASE-<release>'" Variable: • release = 10 to 5000 (in ms) Example: SEND_COMMAND AUDIO_INPUT_1, "'AUDIN_COMPRESSION_RELEASE-200'" Sets the compression release for the audio port to 200.
?AUDIN_COMPRESSION_THRESH	Requests the compression threshold for the audio port. Syntax: SEND_COMMAND <DEV>, "'?AUDIN_COMPRESSION_THRESH'" Example: SEND_COMMAND AUDIO_INPUT_1, "'?AUDIN_COMPRESSION_THRESH'" Returns a COMMAND string of the form: AUDIN_COMPRESSION_THRESH-<threshold> <i>Note: See the AUDIN_COMPRESSION_THRESH command for the compression threshold range.</i>
AUDIN_COMPRESSION_THRESH	Sets the compression threshold for the audio input port addressed by the D:P:S. Syntax: SEND_COMMAND <DEV>, "'AUDIN_COMPRESSION_THRESH-<threshold>'" Variable: • threshold = 0 to -60 (in dB) Example: SEND_COMMAND AUDIO_INPUT_1, "'AUDIN_COMPRESSION_THRESH--10'" Sets the threshold while compressing for selected audio input port to -10 dB.
?AUDIN_GAIN	Requests the gain of the audio port addressed by the D:P:S. Syntax: SEND_COMMAND <DEV>, "'?AUDIN_GAIN'" Example: SEND_COMMAND AUDIO_INPUT_1, "'?AUDIN_GAIN'" Returns a COMMAND string of the form: AUDIN_GAIN-<gain> <i>Note: See the AUDIN_GAIN command for the gain range.</i>
AUDIN_GAIN	Sets the gain for the audio port addressed by the D:P:S to <gain>. Syntax: SEND_COMMAND <DEV>, "'AUDIN_GAIN-<gain>'" Variable: • gain = -24 to 24 (in dB) Example: SEND_COMMAND AUDIO_INPUT_1, "'AUDIN_GAIN-12'" Sets the gain of the audio input port to 12 dB.
?AUDIN_STEREO	Requests the stereo setting of the audio input port addressed by the D:P:S. Syntax: SEND_COMMAND <DEV>, "'?AUDIN_STEREO'" Example: SEND_COMMAND AUDIO_INPUT_1, "'?AUDIN_STEREO'" Returns a COMMAND string of the form: AUDIN_STEREO-<ENABLE DISABLE>
AUDIN_STEREO	Enables or disables the stereo setting on the audio input port addressed by the D:P:S. If enabled, the stereo setting is on. If disabled, the stereo setting is off, which means it is mono. Syntax: SEND_COMMAND <DEV>, "'AUDIN_STEREO-<setting>'" Variable: • setting = stereo setting, either ENABLE or DISABLE Example: SEND_COMMAND AUDIO_INPUT_1, "'AUDIN_STEREO-ENABLE'"

Audio Input SEND_COMMANDS (Cont.)	
Command	Description
?AUDOUT_BALANCE	Requests the current balance setting for the audio port addressed by the D:P:S. Syntax: SEND_COMMAND <DEV>, "'?AUDOUT_BALANCE'" Example: SEND_COMMAND AUDIO_OUTPUT_1, "'?AUDOUT_BALANCE'" Returns a COMMAND string of the form: AUDOUT_BALANCE-<balance> See the AUDOUT_BALANCE command for the balance range.
AUDOUT_BALANCE	Sets the left and right balance for the audio port addressed by the D:P:S. Syntax: SEND_COMMAND <DEV>, "'AUDOUT_BALANCE-<balance>'" Variable: • balance = -20 to +20 steps, left to right (default value is 0). Examples: SEND_COMMAND AUDIO_OUTPUT_1, "'AUDOUT_BALANCE-5'" Sets balance to favor the right speaker for audio output port #1 to 5 steps (+). SEND_COMMAND AUDIO_OUTPUT_1, "'AUDOUT_BALANCE--5'" Sets balance to favor the left speaker for audio output port #1 to 5 steps (-).
?AUDOUT_DELAY	Requests the delay for the audio port addressed by the D:P:S. Syntax: SEND_COMMAND <DEV>, "'?AUDOUT_DELAY'" Example: SEND_COMMAND AUDIO_OUTPUT_1, "'?AUDOUT_DELAY'" Returns a COMMAND string of the form: AUDOUT_DELAY-<delay> See the AUDOUT_DELAY command for the delay range.
AUDOUT_DELAY	Sets the delay for the audio port addressed by the D:P:S. Syntax: SEND_COMMAND <DEV>, "'AUDOUT_DELAY-<delay>'" Variable: • delay = 0 to 200 (in ms) Example: SEND_COMMAND AUDIO_OUTPUT_1, "'AUDOUT_DELAY-50'" Sets the delay for the audio output port to 50 milliseconds.

Audio Output SEND_COMMANDS

Audio Output SEND_COMMANDS	
Command	Description
?AUDOUT_EQ_CF	Requests the center frequency on the specified equalizer band on the audio output port addressed by the D:P:S. Syntax: SEND_COMMAND <DEV>, "'?AUDOUT_EQ_CF-<band>'" Example: SEND_COMMAND AUDIO_OUTPUT_1, "'?AUDOUT_EQ_CF-1'" Returns a COMMAND string of the form: AUDOUT_EQ_CF-<band>, <value> Note: See the AUDOUT_EQ_CF command for the band and value ranges.
AUDOUT_EQ_CF	Sets the center frequency on the specified equalizer band on the audio output port addressed by the D:P:S. Syntax: SEND_COMMAND <DEV>, "'AUDOUT_EQ_CF-<band>, <value>'" Variables: • band = 1 to 10 • value = 20 to 20000 (in Hz) Example: SEND_COMMAND AUDIO_OUTPUT_1, "'AUDOUT_EQ_CF-1=80'" Sets the center frequency on band #1 of audio port 1 equalizer to 80. SEND_COMMAND AUDIO_OUTPUT_2, "'AUDOUT_EQ_CF-5=100'" Sets the center frequency on band #5 of audio port 2 equalizer to 100.
?AUDOUT_EQ_ENABLE	Requests audio EQ enabled status. Syntax: SEND_COMMAND <DEV>, "'?AUDOUT_EQ_ENABLE'" Example: SEND_COMMAND dxDev, "'?AUDOUT_EQ_ENABLE'" Returns a COMMAND string of the form: AUDOUT_EQ_ENABLE-<ON OFF>

Audio Output SEND_COMMANDS (Cont.)	
Command	Description
AUDOUT_EQ_ENABLE	Enables or disables audio EQ on all ports. Syntax: SEND_COMMAND <DEV>, "'AUDOUT_EQ_ENABLE-<setting>'" Variable: <ul style="list-style-type: none"> • setting = desired EQ state, either ON or OFF Example: SEND_COMMAND dxDev, "'AUDOUT_EQ_ENABLE-OFF'"
?AUDOUT_EQ_FT	Requests the filter type on the specified equalizer band on the audio output port addressed by the D:P:S. Syntax: SEND_COMMAND <DEV>, "'?AUDOUT_EQ_FT-<band>'" Example: SEND_COMMAND AUDIO_OUTPUT_1, "'?AUDOUT_EQ_FT-1'" Returns a COMMAND string of the form: AUDOUT_EQ_FT-<band>, <filter> Note: See the AUDOUT_EQ_FT command for the band range and filter types.
AUDOUT_EQ_FT	Sets the filter type on the specified equalizer band on the audio output port addressed by the D:P:S to <filter type>. Syntax: SEND_COMMAND <DEV>, "'AUDOUT_EQ_FT-<band>=<filter type>'" Variables: <ul style="list-style-type: none"> • band = 1 to 10 if on the audio output port. • filter type = Bell, Band Pass, Band Stop, High Pass, Low Pass, Treble Shelf, Bass Shelf Example: SEND_COMMAND AUDIO_OUTPUT_1, "'AUDOUT_EQ_FT-1=Low Pass'" Sets the filter type on band #1 of audio port 1 equalizer to Low Pass.
?AUDOUT_EQ_GAIN	Requests the gain on the specified equalizer band on the audio output port addressed by the D:P:S. Syntax: SEND_COMMAND <DEV>, "'?AUDOUT_EQ_GAIN-<band>'" Example: SEND_COMMAND AUDIO_OUTPUT_1, "'?AUDOUT_EQ_GAIN-1'" Returns a COMMAND string of the form: AUDOUT_EQ_GAIN-<band>, <value> Note: See the AUDOUT_EQ_GAIN command for the band and value ranges.
AUDOUT_EQ_GAIN	Sets the gain on the specified equalizer band on the audio output port addressed by the D:P:S to <value>. Syntax: SEND_COMMAND <DEV>, "'AUDOUT_EQ_GAIN-<band>, <value>'" Variables: <ul style="list-style-type: none"> • band = 1 to 10 • value = -12 to 12 (in dB) Example: SEND_COMMAND AUDIO_OUTPUT_1, "'AUDOUT_EQ_GAIN-1,8'" Sets the gain on band #1 of audio port 1 equalizer to 8. SEND_COMMAND AUDIO_OUTPUT_2, "'AUDOUT_EQ_GAIN-5,-10'" Sets the gain on band #5 of audio port 2 equalizer to -10.
?AUDOUT_EQ_MODE	Requests the current mode of the equalizer for the audio port addressed by the D:P:S. Syntax: SEND_COMMAND <DEV>, "'?AUDOUT_EQ_MODE'" Example: SEND_COMMAND AUDIO_OUTPUT_1, "'?AUDOUT_EQ_MODE'" Returns a COMMAND string of the form: AUDOUT_EQ_MODE-<mode> Note: See the AUDOUT_EQ_MODE command for the list of mode settings.
AUDOUT_EQ_MODE	Sets the mode for the equalizer for the audio port addressed by the D:P:S. Syntax: SEND_COMMAND <DEV>, "'AUDOUT_EQ_MODE-<mode>'" Variables: <ul style="list-style-type: none"> • mode = off, voice, music, movie Example: SEND_COMMAND AUDIO_OUTPUT_1, "'AUDOUT_EQ_MODE-movie'" Sets the equalizer to favor the sounds of a movie for the audio output port.

Audio Output SEND_COMMANDS (Cont.)	
Command	Description
?AUDOUT_EQ_Q	<p>Requests the quality factor (Q) on the specified equalizer band on the audio output port addressed by the D:P:S.</p> <p>Syntax: SEND_COMMAND <DEV>, "'?AUDOUT_EQ_Q-<band>' "</p> <p>Example: SEND_COMMAND AUDIO_OUTPUT_1, "'?AUDOUT_EQ_Q-1' " Returns a COMMAND string of the form: AUDOUT_EQ_Q-<band>, <factor></p> <p>Note: See the AUDOUT_EQ_Q command for the list of band and factor ranges.</p>
AUDOUT_EQ_Q	<p>Sets the quality factor (Q) on the specified equalizer band on the audio output port addressed by the D:P:S to <value>.</p> <p>Syntax: SEND_COMMAND <DEV>, "'AUDOUT_EQ_Q-<band>, <factor>' "</p> <p>Variables:</p> <ul style="list-style-type: none"> band = 1 to 10 if on the audio output port. factor = range depends on filter type (AUDOUT_EQ_FT) Bell range = 0.1 to 20.0 Band Pass range = 0.1 to 20.0 Band Stop range = 0.1 to 20.0 High Pass range = 0.5 to 1.4 Low Pass range = 0.5 to 1.4 Treble Shelf range = 0.5 to 1.0 Bass Shelf range = 0.5 to 1.0 <p>Example: SEND_COMMAND AUDIO_OUTPUT_1, "'AUDOUT_EQ_Q-1, 8' " Sets the Q on band #1 of the audio port 1 equalizer to 8.</p>
?AUDOUT_MAXVOL	<p>Requests the current maximum volume for the audio port addressed by the D:P:S.</p> <p>Syntax: SEND_COMMAND <DEV>, "'?AUDOUT_MAXVOL' "</p> <p>Example: SEND_COMMAND AUDIO_OUTPUT_1, "'?AUDOUT_MAXVOL' " Returns a COMMAND string of the form: AUDOUT_MAXVOL-<maximum></p> <p>See the AUDOUT_MAXVOL command for the maximum volume range.</p>
AUDOUT_MAXVOL	<p>Sets the maximum volume for the audio port addressed by the D:P:S.</p> <p>Syntax: SEND_COMMAND <DEV>, "'AUDOUT_MAXVOL-<maximum>' "</p> <p>Variable:</p> <ul style="list-style-type: none"> maximum = 0 to 100 (in %) <p>Example: SEND_COMMAND AUDIO_OUTPUT_1, "'AUDOUT_MAXVOL-75' " Sets the maximum for the audio output port to 75%.</p>
?AUDOUT_MINVOL	<p>Requests the current minimum volume for the audio port addressed by the D:P:S.</p> <p>Syntax: SEND_COMMAND <DEV>, "'?AUDOUT_MINVOL' "</p> <p>Example: SEND_COMMAND AUDIO_OUTPUT_1, "'?AUDOUT_MINVOL' " Returns a COMMAND string of the form: AUDOUT_MINVOL-<minimum></p> <p>Note: See the AUDOUT_MINVOL command for the minimum volume range.</p>
AUDOUT_MINVOL	<p>Sets the minimum volume for the audio port addressed by the D:P:S.</p> <p>Syntax: SEND_COMMAND <DEV>, "'AUDOUT_MINVOL-<minimum>' "</p> <p>Variable:</p> <ul style="list-style-type: none"> minimum = 0 to 100 (in %) <p>Example: SEND_COMMAND AUDIO_OUTPUT_1, "'AUDOUT_MINVOL-5' " Sets the minimum for the audio output port to 5%.</p>
?AUDOUT_MUTE	<p>Requests audio mute status.</p> <p>Syntax: SEND_COMMAND <DEV>, "'?AUDOUT_MUTE' "</p> <p>Example: SEND_COMMAND dxDev, "'?AUDOUT_MUTE' " Returns a COMMAND string of the form: AUDOUT_MUTE-<ENABLE DISABLE></p>

Audio Output SEND_COMMANDS (Cont.)	
Command	Description
AUDOUT_MUTE	Enables or disables audio muting on the specified port/channel. Syntax: SEND_COMMAND <DEV>, "'AUDOUT_MUTE-<setting>'" Variable: • setting = desired mute state, either ENABLE or DISABLE Examples: SEND_COMMAND dxDev, "'AUDOUT_MUTE-DISABLE'" SEND_COMMAND AUD_OUTPUT_4, "'AUDOUT_MUTE-ENABLE'"
AUDOUT_RESET_EQ	Restores each of the 10 EQ bands on a given port to default settings. Syntax: SEND_COMMAND <DEV>, "'AUDOUT_RESET_EQ'" Example: SEND_COMMAND AUDIO_OUTPUT_1, "'AUDOUT_RESET_EQ'" Resets EQ bands to default settings on audio output port. Default values for EQ bands are: Gain = 0, Center frequency = 31, Q factor = 1.4, and Filter type = BELL.
?AUDOUT_STEREO	Request if audio amp output is in stereo. Syntax: SEND_COMMAND <DEV>, "'?AUDOUT_STEREO'" Example: SEND_COMMAND dxDev, "'?AUDOUT_STEREO'" Returns a COMMAND string of the form: AUDOUT_STEREO-<ENABLE DISABLE>
AUDOUT_STEREO	Enables or disables audio amp output in stereo. If enabled, the stereo setting is on. If disabled, the stereo setting is off, which means it is mono. Syntax: SEND_COMMAND <DEV>, "'AUDOUT_STEREO-<setting>'" Variable: • setting = stereo setting, either ENABLE or DISABLE Example: SEND_COMMAND dxDev, "'AUDOUT_STEREO-ENABLE'"
?AUDOUT_TESTTONE	Requests the current frequency of the test tone for the audio port addressed by the D:P:S. This command <u>must</u> be sent to D:P:S port 1. Syntax: SEND_COMMAND <DEV>, "'?AUDOUT_TESTTONE'" Example: SEND_COMMAND AUDIO_OUTPUT_1, "'?AUDOUT_TESTTONE'" Returns a COMMAND string of the form: AUDOUT_TESTTONE-<frequency> See the AUDOUT_TESTTONE command for the frequency setting.
AUDOUT_TESTTONE	Sets the frequency of a test tone for the audio port addressed by the D:P:S. This command <u>must</u> be sent to D:P:S port 1. Syntax: SEND_COMMAND <DEV>, "'AUDOUT_TESTTONE-<frequency>'" Variable: • frequency = off, 60Hz, 250Hz, 400Hz, 1KHz, 3KHz, 5KHz, 10KHz, PINK NOISE, WHITE NOISE Example: SEND_COMMAND AUDIO_OUTPUT_1, "'AUDOUT_TESTTONE-250Hz'" Sets a test tone of 250 Hz to play for the audio output port.
?AUDOUT_TESTTONE_ENABLE	Requests the current setting of the test tone for the audio port addressed by the D:P:S. Syntax: SEND_COMMAND <DEV>, "'?AUDOUT_TESTTONE_ENABLE'" Example: SEND_COMMAND AUDIO_OUTPUT_1, "'?AUDOUT_TESTTONE_ENABLE'" Returns a COMMAND string of the form: AUDOUT_TESTTONE_ENABLE-<ENABLE DISABLE>
AUDOUT_TESTTONE_ENABLE	Enables or disables the test tone for audio ports. Syntax: SEND_COMMAND <DEV>, "'AUDOUT_TESTTONE_ENABLE-<setting>'" Variable: • setting = Test tone setting, either ENABLE or DISABLE Example: SEND_COMMAND AUDIO_OUTPUT_1, "'AUDOUT_TESTTONE_ENABLE-ENABLE'"

Audio Output SEND_COMMANDS (Cont.)	
Command	Description
?AUDOUT_VOLUME	Requests the volume setting of the specified audio output port addressed by the D:P:S. Syntax: SEND_COMMAND <DEV>, "'?AUDOUT_VOLUME'" Example: SEND_COMMAND AUDIO_OUTPUT_1, "'?AUDOUT_VOLUME'" Returns a COMMAND string of the form: AUDOUT_VOLUME-<value> <i>Note: See the AUDOUT_VOLUME command for the volume value range.</i>
AUDOUT_VOLUME	Sets the volume on the audio output specified by the D:P:S to <value>. Syntax: SEND_COMMAND <DEV>, "'AUDOUT_VOLUME-<VALUE>'" Variable: • value = 0 (-100 dB) to 100 (0 dB) Example: SEND_COMMAND AUDIO_OUTPUT_1, "'AUDOUT_VOLUME-50'" Sets the volume of audio output port #1 to 50 (-50 dB).
?HDMIOUT_AUDIO	Requests the HDMI output port followed by the specified audio port addressed by the D:P:S. Syntax: SEND_COMMAND <DEV>, "'?HDMIOUT_AUDIO'" Example: SEND_COMMAND AUDIO_OUTPUT_1, "'?HDMIOUT_AUDIO'" Returns a COMMAND string of the form: HDMIOUT_AUDIO-<option>
HDMIOUT_AUDIO	Determines which output the HDMI output port addressed by the D:P:S will use. Syntax: SEND_COMMAND <DEV>, "'HDMIOUT_AUDIO-<option>'" Variable: • option = embedded, switched Example: SEND_COMMAND AUDIO_OUTPUT_1, "'HDMIOUT_AUDIO-embedded'" Sets the audio output port (#1 based on D:P:S) to use the audio associated with the HDMI source.

Audio Switching Board Down-mix SEND_COMMANDS

Down-mix SEND_COMMANDS	
Command	Description
?down-mix_DOLBY_DRC	Requests the Dynamic Range Compression setting on the down-mix channel. This command <u>must</u> be sent to D:P:S port 1. Syntax: SEND_COMMAND <DEV>, "'?down-mix_DOLBY_DRC'" Example: SEND_COMMAND 5002:1:1, "'?down-mix_DOLBY_DRC'" Returns a COMMAND string of the form: down-mix_DOLBY_DRC-<AUTO ON OFF>
down-mix_DOLBY_DRC	Enables or disables Dynamic Range Compression on the down-mix channel. This command <u>must</u> be sent to D:P:S port 1. Syntax: SEND_COMMAND <DEV>, "'down-mix_DOLBY_DRC-<option>'" Variable: • option = AUTO, ON, OFF (default = AUTO) Example: SEND_COMMAND 5002:1:1, "'down-mix_DOLBY_DRC-<OFF>'"
?down-mix_SOURCE	Requests the input port acting as the source for the down-mix option. This command <u>must</u> be sent to D:P:S port 1. Syntax: SEND_COMMAND <DEV>, "'?down-mix_SOURCE'" Example: SEND_COMMAND 5002:1:1, "'?down-mix_SOURCE'" Returns a COMMAND string of the form: down-mix_SOURCE-<input>
down-mix_SOURCE	Sets an input port to act as the source for the down-mix option. This command <u>must</u> be sent to D:P:S port 1. Syntax: SEND_COMMAND <DEV>, "'down-mix_SOURCE-<input>'" Example: SEND_COMMAND 5002:1:1, "'down-mix_SOURCE-<13>'"

DXLink Endpoint SEND_COMMANDS

IMPORTANT: The commands in this section affect endpoints, but are addressed to the input or output port connected to the associated endpoint.

DXLink Endpoint SEND_COMMANDS	
Command	Description
?ENDPOINT_TX_ICSLAN_PORT	Requests the IP configuration of the ICSLAN port on the DXLink TX. Note: Does not apply to DXLink Wallplates. Syntax: SEND_COMMAND <DEV>, "'?ENDPOINT_TX_ICSLAN_PORT'" Example: SEND_COMMAND 5002:13:1, "'ENDPOINT_TX_ICSLAN_PORT'" Returns a COMMAND string of the form: ENDPOINT_TX_ICSLAN_PORT-<PRIVATE PUBLIC>
ENDPOINT_TX_ICSLAN_PORT	Changes the IP configuration of the ICSLAN port on the DXLink TX. Note: Does not apply to DXLink Wallplates. Syntax: SEND_COMMAND <DEV>, "'ENDPOINT_TX_ICSLAN_PORT-<PRIVATE PUBLIC>'" Example: SEND_COMMAND 5002:13:1, "'ENDPOINT_TX_ICSLAN_PORT-PRIVATE'" Note: Default setting for DXLink endpoints is PUBLIC.
?ENDPOINT_RX_ICSLAN_PORT	Requests the IP configuration of the ICSLAN port on the DXLink RX. Syntax: SEND_COMMAND <DEV>, "'?ENDPOINT_RX_ICSLAN_PORT'" Example: SEND_COMMAND 5002:14:1, "'?ENDPOINT_RX_ICSLAN_PORT'" Returns a COMMAND string of the form: ENDPOINT_RX_ICSLAN_PORT-<PRIVATE PUBLIC>
ENDPOINT_RX_ICSLAN_PORT	Changes the IP configuration of the ICSLAN port on the DXLink RX. Syntax: SEND_COMMAND <DEV>, "'ENDPOINT_RX_ICSLAN_PORT-<PRIVATE PUBLIC>'" Example: SEND_COMMAND 5002:14:1, "'ENDPOINT_RX_ICSLAN_PORT-PRIVATE'" Note: Default setting for DXLink endpoints is PUBLIC.

NetLinx NX Master Telnet Commands

The table below contains Telnet commands which apply to the integrated NetLinx NX Master.

NOTE: For further information about using Telnet commands and a complete list of commands available for NetLinx NX Central Controllers, see the NX-Series Controllers WebConsole & Programming Guide at www.amx.com.

NetLinx NX Telnet Commands for the Integrated NetLinx NX Master	
Command	Description
AUTO LOCATE (ENABLE DISABLE STATUS)	Enables/disables/queries the auto locate feature on the integrated Master. Auto locate adds additional broadcast information for use by AMX Touch Panel devices configured in Auto connect mode. Syntax: Auto Locate [enable disable status]
DOT1X (ENABLE DISABLE STATUS)	Enables/disables 802.1x security or displays its current settings. The default settings is disable. Syntax: DOT1X[status enable disable]
MANAGE FIRMWARE	Telnet interface to load previous and factory firmware versions for both the integrated Master (device 0) and controller (device 5001). Example: >manage firmware Devices ----- 0 - Master 5001 Select device or press return to cancel:0 Current Version: 1.2.259 Previous Version: 1.2.258 Factory Version: 1.2.250 To install a firmware version: Enter P (Previous), F (Factory) or press return to cancel:
PROGRAM (ENABLE DISABLE STATUS)	Enable/disable the NetLinx program or display the status of the current program execution setting. The default setting is enable. Note: For information on using this command, see page 79. The setting (enable or disable) persists through power down and through firmware updates, etc., until a new command is sent. If the software setting is disabled, then the NetLinx program is disabled. Syntax: PROGRAM [status enable disable]

NetLinx NX Telnet Commands for the Integrated NetLinx NX Master (Cont.)	
Command	Description
PROGRAM INFO	<p>Displays a list of program files and modules residing on the integrated Master.</p> <p>Example:</p> <pre>>PROGRAM INFO -- Program Name Info -- Module Count = 1 1 Name is i!-PCLinkPowerPointTest -- File Names = 2 1 = C:\Program Files\AMX Applications\i!-PCLinkPowerPoint 2 = C:\Program Files\Common Files\AMXShare\AXIs\NetLinx.axi 2 = Name is MDLPP --File Names = 2 1 C:\AppDev\i!-PCLink-PowerPoint\i!-PCLinkPowerPointMod.axs 2 C:\Program files\Common Files\AMXShare\AXIs\NetLinx.axi</pre>
REBOOT	<p>Reboots the integrated Master or specified device. Options for rebooting the Master are cold, soft, and warm. The reboot command with no parameter executes as "reboot cold".</p> <p>Example (Rebooting device):</p> <pre>>REBOOT [0:1:0] Rebooting...</pre> <p>Example (Rebooting Master):</p> <pre>>reboot cold Reboots the Master and restarts the entire operating system. >reboot warm >reboot soft Reboots the Master but only starts the AMX NetLinx application firmware.</pre>

NOTE: Use the Enova DGX Configuration Tool located at www.AMX.com/enova to determine the power requirements of a configuration and whether any of the DXLink Transmitters or Receivers should be powered with the local power supply to maintain power supply redundancy in the Enova DGX 32 enclosure.

Firmware Upgrade & Info for Network Admin

Overview

The NetLinx Studio software application (available for free download from www.amx.com) provides the ability to transfer firmware KIT files to a NetLinx device or a Master (such as the integrated Master on the Enova DGX Switcher). A KIT file (*.KIT) is a package of several files, all of which are required to upgrade the firmware and are available online at www.amx.com. Firmware download links are provided in the relevant product page. This chapter also includes an additional task normally handled by Network Administrators: changing the proxy setting (page 237).

Preparation Checklist for Firmware Upgrade

IMPORTANT: *Verify that you are using the latest version of NetLinx Studio and the latest firmware KIT files for both the integrated Master and the Enova DGX Switcher.*

Preparation Checklist:

- Launch NetLinx Studio. Under the Settings menu, check the Master Communication Settings.
- Verify that the latest version of NetLinx Studio is on your PC.

If the version is not the latest –

Open NetLinx Studio's Help menu and select Web Update to obtain the latest version.

- or -

Go to www.amx.com and login as a Dealer to download the latest version.

- If you need to establish a LAN connection – Insert one end of an RJ-45 cable into the LAN 100/1000 port on the Enova DGX enclosure, and connect the other end of the RJ-45 cable to a network with a DHCP server. (The upgrade can also be done with a static IP address.)
- Verify that the Enova DGX Switcher is powered on. If not, apply power according to the directions on page 67.
- Open the OnLine Tree (OnLine Tree tab of the Workspace window), which displays information about each online device, including the current firmware version.
- Determine the Device Number assigned to the target Enova DGX Switcher.
The integrated Master's device number is always 0 (zero) and cannot be changed.
By default, the Device Number assigned to the Enova DGX Switcher in NetLinx Studio is 05002.
- Before attempting to upgrade the firmware, you must have the appropriate KIT files. Go to www.amx.com and download the latest firmware files for the system from the Enova DGX 800, Enova DGX 1600, Enova DGX 3200, or Enova DGX 6400 product page.
- Check the cache settings in your web browser and set to "Every time I visit the webpage" (otherwise, the progress status *will not* be accurate). When the upgrade is complete, remember to change back to the original cache settings. If you need instructions, see page 238.

NOTE: *Place KIT files on a local drive for speedy throughput.*

Sending Firmware (*.KIT) Files to the Enova DGX

NetLinx Devices such as the Enova DGX Switcher use KIT files for firmware upgrades.

The Enova DGX Switcher contains two components (devices) which each require a Kit file. These two components must be kept at compatible firmware versions for proper operation.

- NetLinx integrated Master Controller – Device ID **0** (zero)
- Enova DGX 800/1600/3200/6400 Switcher – Default Device ID **5002**

IMPORTANT: *Any programs using the USB connection to an Enova DGX 100 Series Switcher must be halted prior to the upgrade process being initiated to avoid breaking the USB link to the PC.*

CAUTION: *If for any reason the KIT file transfer or the upgrade process fails, continue to retry until successful. Do not reboot or power cycle the Enova DGX Switcher or change the connections until the files are transferred and the upgrade process is complete. Failure to complete both the transfer of files and the upgrade successfully may require a factory repair of the Enova DGX Switcher.*

1. Complete any necessary items under the "Preparation Checklist" on the previous page.
2. In NetLinx Studio, choose **Tools > Firmware Transfers > Send to NetLinx Device** to open the Send to NetLinx Device dialog (FIG. 122):

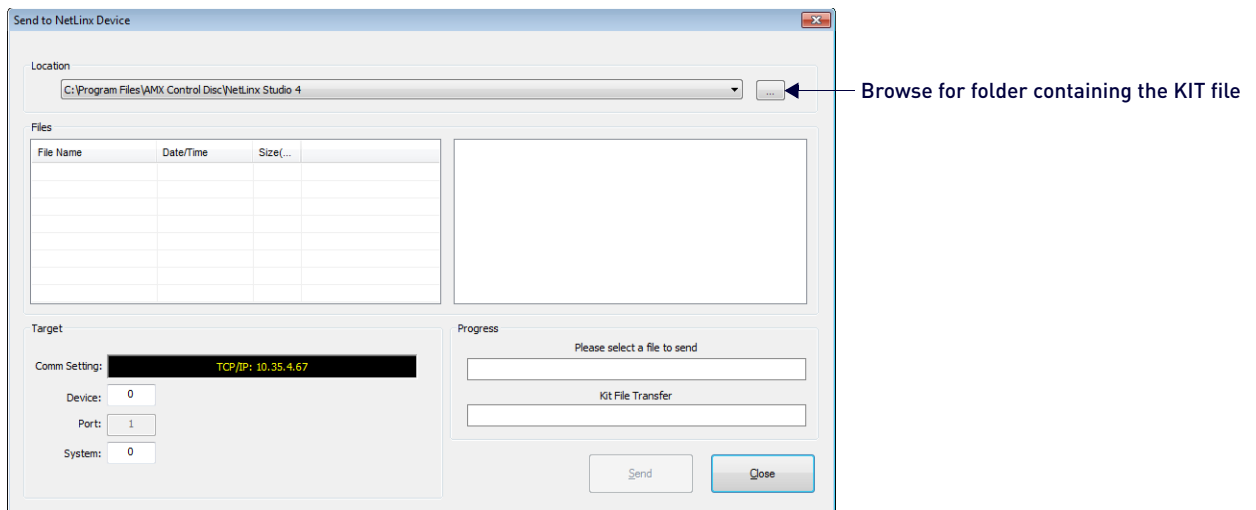

FIG. 122 Send To NetLinx Device dialog (NetLinx Studio)

3. Click Browse (...) to locate target directory in the *Browse For Folder* dialog. Select the desired files for the Master upgrade and the switcher upgrade and click **OK**:

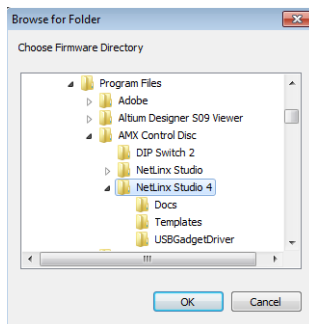

FIG. 123 Send To NetLinx Device dialog (NetLinx Studio)

4. Select the "Master" KIT file from the *Files* list:

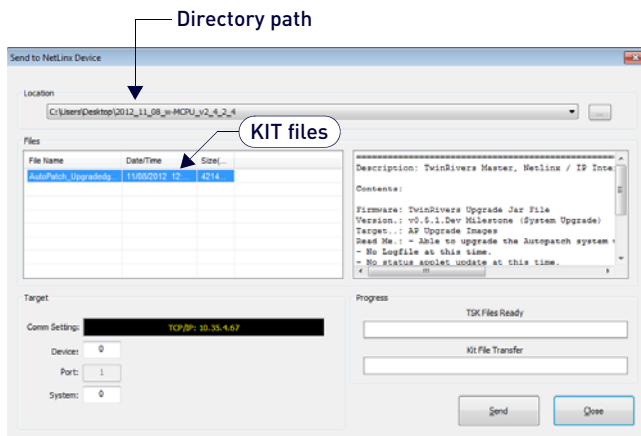

FIG. 124 Send To NetLinx Device dialog showing KIT file for the integrated Master selected

If both require updates, always upgrade in the following order:

Device 0 – NetLinx integrated Master

Device 5002 (default) – Enova DGX

- The selected directory path is displayed in the Send to NetLinx Device dialog (Location field).
 - Assuming the specified target directory contains one or more KIT files, the KIT files in the selected directory are displayed in the Files list along with the last modified date and time.
5. Check the number for the device to be upgraded in the Device text box.
 - The device number assigned to the integrated Master is **0** (zero).
 - The switcher's default device number is **5002**. (If the device number has been changed, use the OnLine Tree to determine it.)
 6. Review the File and Target Device information before you send the KIT file.

Master Upgrade

- Click **Send**. NetLinx Studio transfers the files to the integrated Master on the Enova DGX Switcher and then tells the system to reboot.

NOTE: During the Master upgrade process, some of the LEDs on the CPU go through an extended series of blinking. When finished, all LEDs return to their normal state.

Enova DGX 100 Series Upgrade (Offline Upgrade)

IMPORTANT: Upgrading the switcher's firmware can take a considerable amount of time depending on the components being upgraded in the system. To monitor progress, see the bulleted list in Step 8.

- Select the "Enova DGX" KIT file from the files list and click **Send**. NetLinx Studio transfers the files to the Enova DGX Switcher and then tells the system to restart, at which time the upgrade process begins.

NOTE: During the upgrade process, the Enova DGX Switcher stays offline (does not display in OnLine Tree).

To check the progress during the switcher's upgrade process, any or all of the following can be monitored:

- Some of the LEDs on the CPU blink depending on the components being upgraded.
- The I/O buttons flash one at a time, starting with Input 1 and going through to the last output. The flashing sequence repeats until the upgrade is complete.
- Upgrade status is displayed in the System Configuration interface and updates periodically.

The "XXofYY" indicates the current file number being processed and the total number of upgrade files (some update slowly - some quickly).

The "XX_DviHdmiOutAp" indicates that "XX" is the file for a DVI or HDMI output board (or whatever component is being upgraded). The "%%" indicates the progress of the "XX" file.

NOTE: To open the System Configuration interface, enter the IP address (available through the Control Panel's LCD menu: Function/Setup Options/Master Info/IP Address) in your web browser.

- Upgrade status is displayed on the Control Panel's LCD and updates periodically. The display is identical to the message in the System Configuration interface.
- Enova DGX 6400 only - the power indicator LED on the front flashes green to indicate the system's input/output boards are being upgraded.

NOTE: The LED's response to power functions supersedes the upgrade function.

IMPORTANT: Power cycles will not abort the upgrade; let it run until completion.

Once the upgrade is complete:

- The LEDs return to normal.
- Displays in the System Configuration interface and on the Control Panel's LCD.
- The Enova DGX Switcher comes back online (displays in OnLine Tree).

Changing the Proxy Setting

If the System Configuration interface does not open during setup, try the following:

- Check all power, signal, and link connections on all of the equipment.
- Check LED indicators for the TCP/IP (RJ-45) connector on the Enova DGX enclosure.
- If the LED indicators are not illuminated, check the cable type to make sure it meets cable requirements (see page 70).
- Verify the integrated Master's IP address via the control panel (see page 259) or via NetLinX Studio (see page 210).
- Try connecting to the System Configuration interface again.

Adding an Exception to the Proxy Settings

If the System Configuration interface still does not open, you may need to add an exception in the Proxy Setting dialog. The following instructions apply to Internet Explorer. To change these settings in another browser, consult its Help file.

1. From the Tools menu on the browser, select **Internet Options**. The Internet Options dialog opens. Select the **Connections** tab.

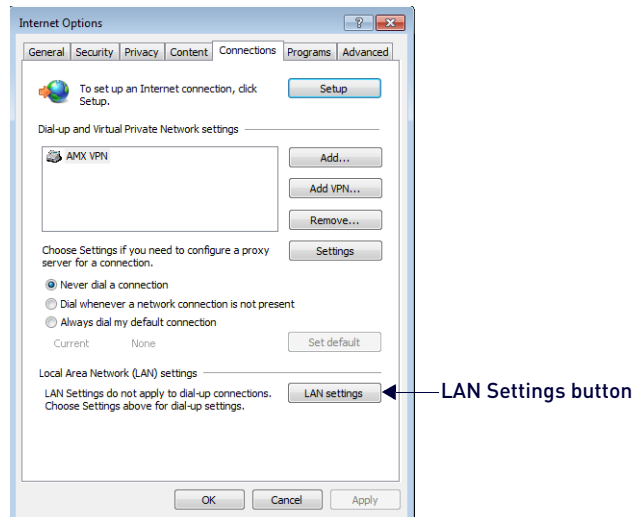

FIG. 125 Internet Options dialog - Connections tab

2. Click **LAN Settings**. The *Local Area Network (LAN) Settings* dialog opens. If the Proxy server box is checked, go to Step 4. If the Proxy server box is not checked, check it before going to Step 4 (FIG. 126):

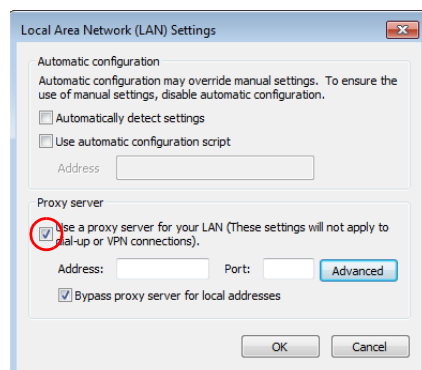

FIG. 126 Local Area Network (LAN) Settings dialog

3. Click **Advanced**. The *Proxy Settings* dialog opens (FIG. 127):

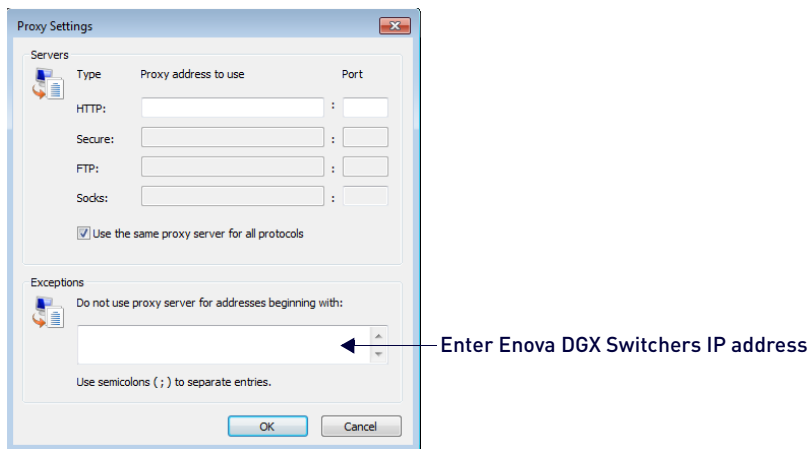

FIG. 127 Proxy Settings dialog

4. In the *Exceptions* field, enter the appropriate IP address for the Enova DGX Switcher (see page 259).
5. Click **OK** to exit each of the dialog boxes used in these steps.

Checking Cache Settings in a Web Browser

Before starting a firmware upgrade, we recommend checking the cache settings (used for storing pages) in your web browser and changing the setting to "Every time I visit the webpage" (otherwise, the progress status of the upgrade will not be accurate).

1. In the Internet Explorer Tools menu, select Internet Options to open the Internet Options dialog.
2. On the General tab under Browsing History, click **Settings**. The *Website Data Settings* dialog opens. Under "Check for new versions of stored pages," select "Every time I visit the webpage" (FIG. 128):

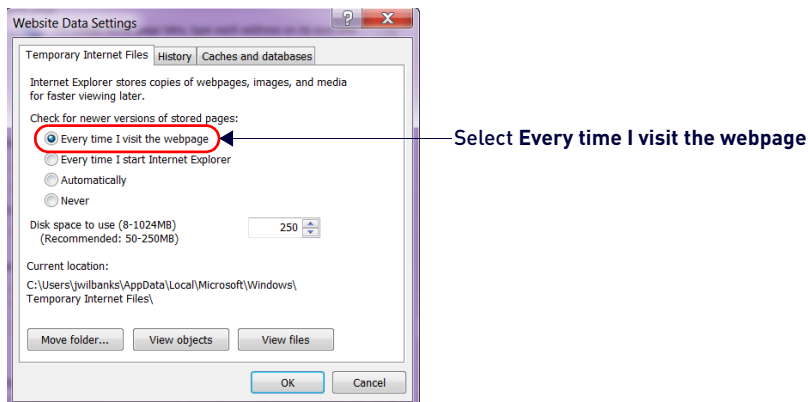

FIG. 128 Website Data Settings dialog

3. Click **OK** to exit.

NOTE: *When the upgrade is complete, repeat steps to restore original setting.*

Appendix A - Adding or Replacing Boards

Overview

This appendix covers the removal and replacement procedure for the Enova DGX input and output boards listed in the tables below. Enova DGX input and output boards are hot-swappable, i.e., the procedure can be done while the system is powered up. The Enova DGX Audio Switching Boards are hot-swappable.

NOTE: *Enova DGX A/E Boards are **not** hot-swappable.*

Input and Output Boards

Input and Output Boards		
Type	Part #	Model
Enova DGX HDMI 4K60 Boards		
Input	FG1061-542	DGX-I-HDMI-4K60
Output	FG1061-552	DGX-O-HDMI-4K60
Enova DGX HDMI Boards		
Input	FG1058-540	DGX-I-HDMI
Input	FG1061-540	DGX-I-HDMI-4K
Output	FG1058-550	DGX-O-HDMI
Enova DGX DVI Boards		
Input	FG1058-600	DGX-I-DVI
Output	FG1058-610	DGX-O-DVI
Enova DGX DXLink™ Twisted Pair Boards		
Input	FG1058-570	DGX-I-DXL
Output	FG1058-580	DGX-O-DXL
Enova DGX DXLink™ Twisted Pair 4K Boards		
Input	FG1061-570	DGX-I-DXL-4K
Output	FG1061-580	DGX-O-DXL-4K
<i>Note: Before connecting a Solecis Digital Switcher to a DXLink Twisted Pair Input Board in an Enova DGX 100 Series Digital Media Switcher, both the Solecis unit and all DXLink Twisted Pair boards must be upgraded with the latest available firmware versions. Solecis units <u>must</u> be upgraded before connecting a unit to an upgraded input board.</i>		
DXLink Fiber Boards, Duplex and Simplex		
Input	FG1058-622	DGX-I-DXF-MMD
Output	FG1058-632	DGX-O-DXF-MMD
Input	FG1058-620	DGX-I-DXF-SMD
Output	FG1058-630	DGX-O-DXF-SMD
Input	FG1058-623	DGX-I-DXF-MMS
Output	FG1058-633	DGX-O-DXF-MMS
Input	FG1058-621	DGX-I-DXF-SMS
Output	FG1058-631	DGX-O-DXF-SMS

IMPORTANT: *Enova DGX 4K HDMI Boards are only compatible with Enova DGX 100 Series enclosures or Enova DGX legacy enclosures that have been upgraded with 100 Series CPUs. Enova DGX 4K60 HDMI Boards are only compatible with Enova DGX 100 enclosures built on or after June 1st, 2016.*

Expansion Boards

IMPORTANT: Audio Switching Boards, Dante Audio Switching Boards, and Audio Insert/Extract Boards are not compatible. Do not install mixed types of expansion boards in the same enclosure. If two types of boards are present, the audio subsystem is disabled.

Expansion Boards		
Type	Part #	Model
Dante Audio Switching Board Sets		
Audio Switching Board Set (one each, input and output) for Enova DGX 800/1600/3200	FG1061-832	DGX3200-ASB-DAN (DANTE AUD SWITCH BOARD KIT)
Audio Switching Board Set (two each, input and output) for Enova DGX 6400	FG1061-864	DGX6400-ASB-DAN (DANTE AUD SWITCH BOARD KIT)
Audio Switching Board Sets		
Audio Switching Board Set (one each, input and output) for Enova DGX 800/1600	FG1061-716	DGX800/1600-ASB (Enova DGX 800/1600 AUD SWITCH BOARD KIT)
Audio Switching Board Set (one each, input and output) for Enova DGX 3200	FG1061-732	DGX3200-ASB (Enova DGX 3200 AUD SWITCH BOARD KIT)
Audio Switching Board Set (two each, input and output) for Enova DGX 6400	FG1061-764	DGX6400-ASB (Enova DGX 6400 AUD SWITCH BOARD KIT)
<i>Note: For Dante ASB connector wiring information, see page 165. For ASB connector wiring information, see page 177.</i>		
IMPORTANT - Enova DGX 6400 – Audio Switching Input Boards <u>must</u> be installed directly above standard Input Boards in left and right slots and Output Boards <u>must</u> be installed directly below standard Output boards in left and right slots.		
Enova DGX Audio Insert/Extract Board		
Audio Insert/Extract	FG1058-705	DGX-AIE
<i>Note: AIE Boards can be replaced or added using the procedure in this appendix. However, we recommend using the procedure in the "Audio Insert/Extract Board" chapter because it includes instructions for setting the DIP switches to insert or extract audio (see page 186).</i>		

IMPORTANT: If you plan to use the instructions in this appendix, remember that Enova DGX expansion boards must be installed in expansion board slots. Although Audio Switching Boards are hot-swappable, Audio Insert/Extract Boards are not hot-swappable; be sure to power down the system.

Procedure Overview

IMPORTANT: Adding or replacing boards should only be done by personnel trained to handle ESD sensitive parts and assemblies.

ESD WARNING: To avoid ESD (Electrostatic Discharge) damage to sensitive components, make sure you are properly grounded before touching any internal Enova DGX materials. Use an ESD wristband and cord with an alligator clip attached to a good ground source.

Items Required

- Enova DGX board(s)
- Phillips #1 screwdriver
- ESD wristband and cord with alligator clip
- PC with NetLinx Studio (or another terminal emulation program) and a null modem serial cable (RS-232)

Safety Recommendations for Laser Products

WARNING: DXLink Fiber uses a Class 1 laser product to send signals. While the Class 1 category indicates that the invisible laser used is safe, we recommend avoiding direct eye exposure when using any optical fiber product (see the OSHA directive on page 146).

CAUTION: Use of controls or adjustments or performance of procedures other than those specified herein may result in hazardous radiation exposure.

IMPORTANT: No user serviceable parts are included inside Enova DGX enclosures; service should only be done by qualified personnel.

- Exercise caution when installing DXLink Fiber products to avoid direct eye exposure to invisible laser radiation. Follow the recommendations below whenever installing or working with these fiber products.
- Be sure to apply the power only after all fiber connections are made and no fiber ends are exposed.
- Do not remove dust plugs from DXLink Fiber connectors or the dust caps from the fiber cables until establishing connections; avoid direct eye exposure.
- Make sure all cables, including fiber cables, are correctly connected and/or terminated.
- Before you unplug a fiber cable on an input board, disconnect the power on the Transmitter that is connected to the input.
- Before you unplug a fiber cable on an output board, disconnect the switch for that output connector.

Adding or Replacing a Board

When replacing a board, be sure to install the new board in the same slot that held the original board to make sure the switching commands are correct.

Enova DGX 100 Series Switchers are configured to accommodate a full enclosure's worth of boards and do not require modification to the configuration file when a board is added. In the following procedure, read each step entirely.

IMPORTANT: *The Audio Insert/Extract board is not hot-swappable; when installing an AIE Board, be sure to power down the system.*

To remove and replace an Enova DGX board:

1. **Optional** – If the board being replaced has custom settings that have not been saved, use the System Configuration interface to save the settings now (see page 133).
2. **Enova DGX 3200 only** – Loosen the captive screw on each end of the connector numbering plate above the boards (FIG. 129), and set the plate aside.

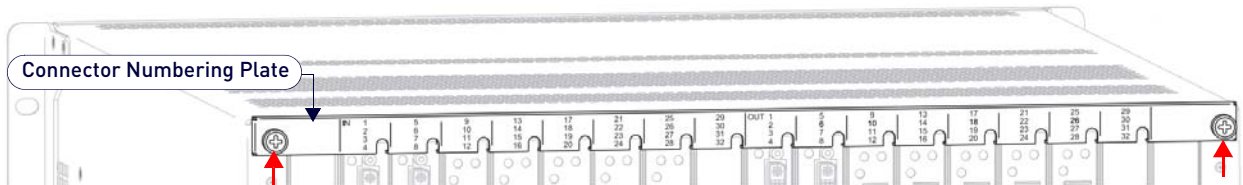

FIG. 129 Connector Numbering Plate (DGX 3200)

NOTE: *If applicable - Label and disconnect all cables on the board being replaced. If cables from adjoining boards obstruct access, label and disconnect them as necessary.*

3. **Remove blank board plate**
 - a. Remove the screw that holds the board plate in place (for Enova DGX 3200, see FIG. 130; for Enova DGX 800/1600/6400, see FIG. 131).
 - b. Pull the plate out of the board slot opening (the tab on the end of the board plate fits in a slot near where the ejector handle would otherwise go). The plate consists of an aluminum sleeve with a black metal piece, which slides in and out of the sleeve, and an EMI (Electromagnetic Interference) gasket.

- or -

Remove the current board

- a. Remove the pan head screw that holds the board in place
 - **DGX 3200:** Push board extractor handle down, and then pull board straight out (FIG. 130):

One screw holds each board or board plate in place

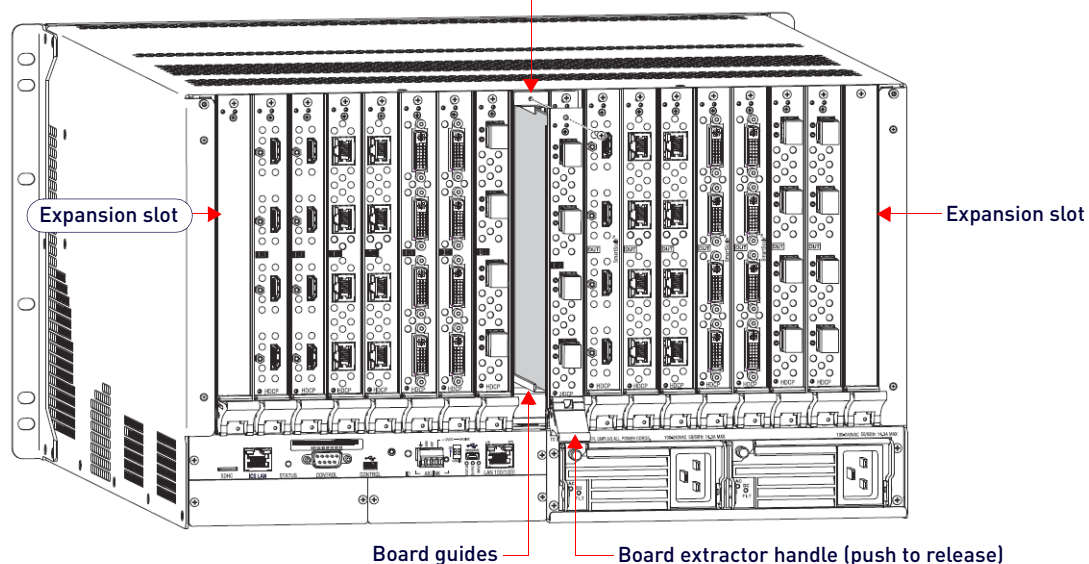

FIG. 130 Vertical board removal (DGX-3200)

- **DGX 800/1600/6400:** Push extractor handle right (input) or left (output), pull board straight out (FIG. 131):

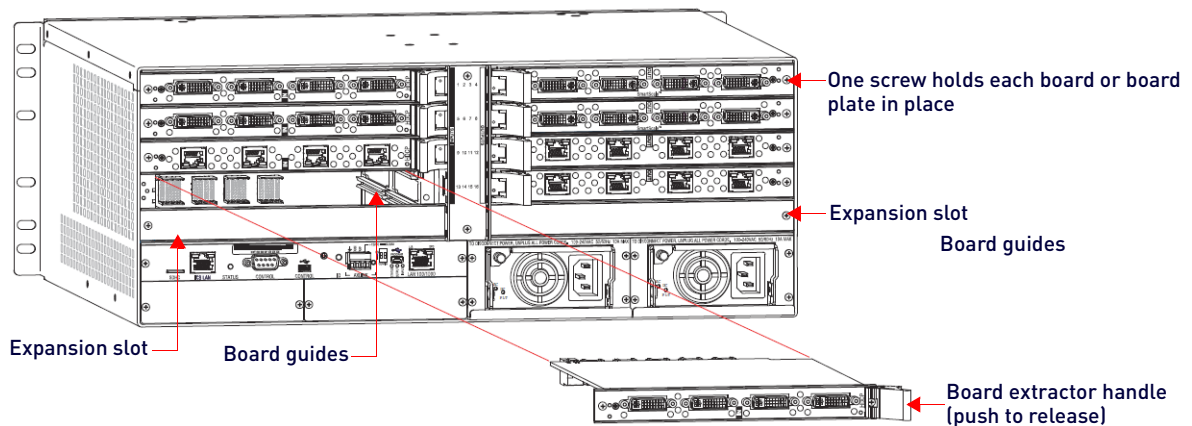

FIG. 131 Horizontal board removal (DGX 800/1600/6400)

- b. Place the board in an ESD approved static shield bag and set aside.

CAUTION: Each Enova DGX board has an EMI gasket along one edge of the faceplate. Handle the boards carefully to avoid dislodging or damaging the gasket on the board being installed and the gasket on the adjacent board or blank plate.

CAUTION: For DXLink Fiber Boards, do not remove dust plugs from their fiber connectors until Step 12.

4. **Audio Switching Boards (ASB and ASB-DAN) only –**

- Do not install in enclosure with AIE boards.
- Must be installed in pairs.
- Must be installed in expansion slots.
- Enova DGX 6400 only – Be sure to install all four boards in correct expansion slots.
- For Enova DGX 800/1600/3200 systems only – Attach HSSI cable from SMA port on ASB Input Board to SMA port on ASB Output Board.

5. **Audio Insert/Extract Boards only –** See page 187 for information on setting the DIP switches to configure the insert/extract functionality.

- Flip the DIP switch for each connector that needs its setting changed.
- Write down the setting for each connector to make verifying correct audio switching behavior easier in Step 14.
- AIE Boards can only be installed in an expansion slot.

NOTE: Unused AIE connectors must be set to Disable/Extract.

6. **Install vertical boards –** With the board's extractor handle in the extended (unlocked) position, line up the board's edges on the board guides that are along the top and bottom of the board slot,

- or -

Install horizontal boards – With the board's extractor handle in the extended (unlocked) position, line up the board's edges on the board guides that are along the left and right of the board slot. Note that input boards have board guides at the top of the slot and board guides for the output boards are at the bottom of the slot due to their reversed orientation in the enclosure.

7. Begin pushing the board into the slot until the extractor handle starts to engage the metal extractor plate (the extractor handle moves into its folded position). When the extractor handle starts to lift, flip the handle toward the center of the board until it snaps into its folded (locked) position, which firmly seats the board.
8. Fasten the screw (which was removed in Step 4) that holds the board in place. This screw *must* be tightened securely before cables are attached in Step 12.
9. If the enclosure was powered down – Plug the AC power cords back into the power supplies.
10. Verify that the system recognizes the board:
 - a. Launch the System Configuration interface
 - b. Navigate to the Switcher/Status page.
 - c. Scroll down to the Input or Output Board slot number of the new board. Audio boards will be listed under "expansion boards."
 - d. Ensure that the board's Status is "OK" and that the Type field is correct.
 - e. If the fields do not reflect the board you have inserted, or the board Status states "FAIL," re-seat the board and check the Status page again.
 - f. If the firmware version on a board does not match the enclosure (indicated with an asterisk in the Version column), download the latest .kit file and send it to the enclosure (instructions on page 203).

NOTE: If using a cable management bar, tie the cable to the cable management bar far enough below the connector to allow for the manufacturers recommended bend radius.

11. Attach cables to the board's connectors and reconnect any other cables that were disconnected in Step 3
 - Tie cables to cable management bars (if applicable).
 - If the enclosure was powered down – Reapply power.

NOTE: For cabling information, see the specific board chapter in this manual.
12. **Optional** – If you have custom board settings to load to the board, use the System Configuration interface to load them now (see page 184).
13. Execute a test switch using a connection on the new board to be sure that video is present at the destination (Control Panel: press Function key, Select key, Input key, Output key, and Take key). See the *Executing a Test Switch* section on page 70 for details.

Additional testing for Audio Insert/Extract Board functionality:

Insert function – If the DIP switch for the audio connector is set to insert, the video signal from the corresponding video input or output will carry the inserted audio; check that the inserted audio is present with the display.

Extract function – If the DIP switch for the audio connector is set to extract, the audio will be extracted from the corresponding video input or output signal; check the auxiliary or supplemental audio equipment involved to be sure the extracted audio signal is present where expected.

NOTE: If the test switch does not work, see the *Board Troubleshooting* section on page 243.

IMPORTANT: If for any reason a board slot is left empty, be sure to attach a blank plate to cover it.
14. **Enova DGX 3200 only** – Replace connector numbering plate removed in Step 2.

Board Troubleshooting

Problems with Board Power Up

To verify that all I/O boards have been powered up after hot-swapping, enter `~scri6v3!` in a terminal emulation program and verify that none of the boards report an alarm.

If an alarm is reported, the board must be manually powered back up using the `DGX_SHELL` command `power ON BCPUx` where `x` is the slot number of the board (for additional information on `DGX_SHELL` commands, see page 247).

NOTE: A complete list of the `DGX_SHELL` targets, `BCPUx`, is in the "Product to Board Slot Correspondence" table on page 248.

Appendix B - Replacing Battery on CPU

Overview

This appendix provides instructions for removing and installing the battery on the CPU for the Enova DGX 100 Series and setting the CPU's clock. The procedure can be done while the enclosure is in a rack, but the system must be powered down.

The Enova DGX Switcher uses a coin-type (button cell) lithium battery in a timekeeper function. Only one CPU battery is installed within a given enclosure. The battery can be expected to have up to 4.25 years of usable life under very adverse conditions. Actual life is appreciably longer under normal operating conditions. This calculation is based on storing the unit without power in 50° C (122° F) temperature until battery levels are no longer acceptable.

WARNING: Risk of explosion if battery is replaced by an incorrect type.

Removing and Installing the CPU Battery

CAUTION: Do not remove the CPU board until you are ready to install the CPU battery, unless directed to do so by technical support.

Items Required

- Replacement battery for Enova DGX CPU
- Phillips #1 screwdriver
- ESD wristband and cord with alligator clip

ESD WARNING: To avoid ESD (Electrostatic Discharge) damage to sensitive components, make sure you are properly grounded before touching any internal Enova DGX materials. Use an ESD wristband and cord with an alligator clip attached to a good ground source.

Instructions are provided for removing and installing the battery on the CPU and setting the CPU's clock.

Removing and Installing an DGX CPU Battery

1. Disconnect *all AC power cords* (Enova DGX 800/1600/3200 – two power cords; Enova DGX 6400 - four power cords). Make sure that none of the power supply LEDs are illuminated.
2. Disconnect *all cables* connected to the CPU and unplug the AxLink connector.
3. Enova DGX 800/1600/3200 – Remove the three screws from the CPU faceplate (FIG. 132):



FIG. 132 CPU board DGX 800/1600/3200 - Remove screws indicated

NOTE: Removal of the CPU board is easier if the two metal plates under the CPU are removed first.

4. Enova DGX 6400 – Remove the four screws from the CPU faceplate (FIG. 133):

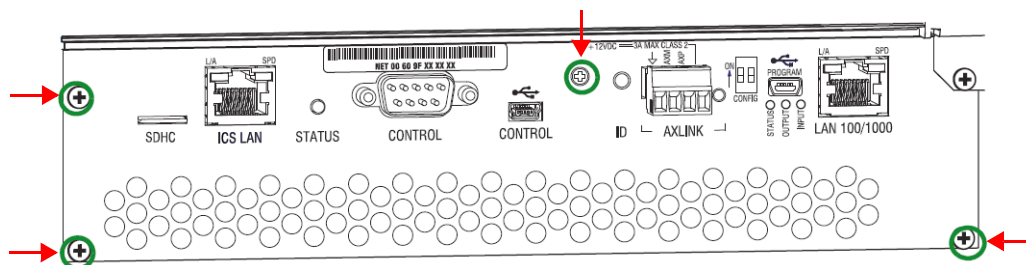

FIG. 133 CPU board DGX 6400 - Remove screws indicated

5. Remove the CPU faceplate and set aside.

IMPORTANT: The CPU *does not need to be extracted all the way to replace the battery.*

6. Use the tab indicated in FIG. 134 to pull the CPU board approximately four inches straight out of the enclosure:

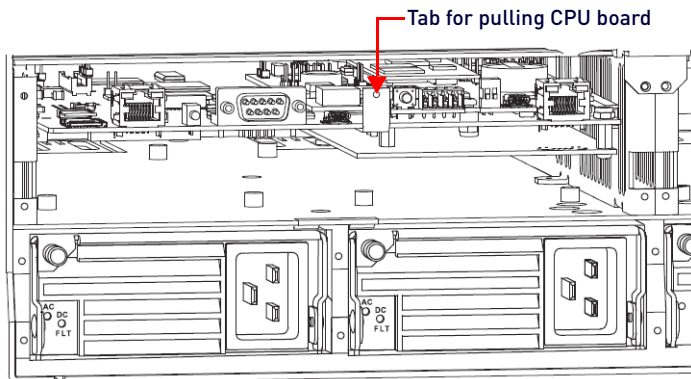

FIG. 134 Enova DGX 6400 - Tab for pulling CPU board

NOTE: The CPU battery is fully exposed when the CPU board is extended four inches.

7. Locate the CPU battery on top of the CPU (FIG. 135):

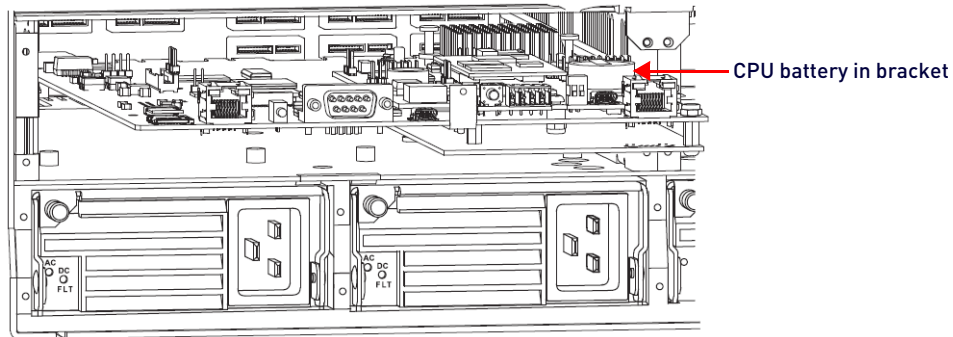

FIG. 135 CPU battery bracket

8. Pull the dead battery out from under the bracket that holds it in place.

NOTE: Place thumbnail into access slot under front side of battery and simultaneously push down on the far lip of the battery while pulling the battery clear of the bracket.

9. Dispose of old battery as mandated by your area or country guidelines.
10. Slide the replacement battery, positive side up (+), into place under the battery bracket.
11. Slowly push the CPU board back into the slot firmly enough to make a good electrical connection (avoid pushing on the connectors). When the board is fully inserted, the faceplate that covers the CPU should sit flush with the back metal.
12. Reattach the faceplate with the screws that were removed in Step 3 (Enova DGX 800/1600/3200) or Step 4 (Enova DGX 6400).
13. Plug in *all AC power cords*.
14. Check the Status LED on the CPU for indications of normal display (FIG. 136):

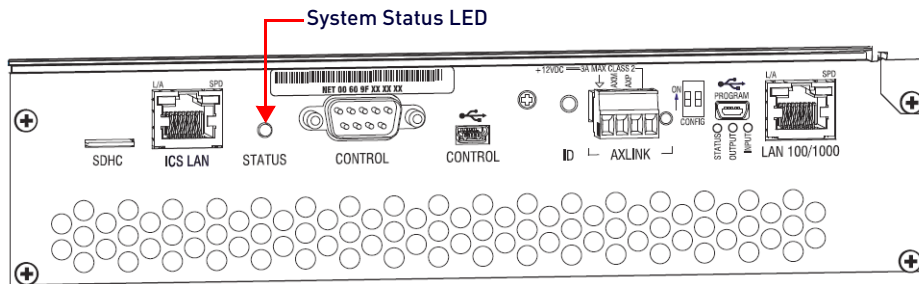

FIG. 136 System Status LED

CPU LED Indicator	Normal Display	Cautionary Display
System Status	<ul style="list-style-type: none"> • Solid amber during boot load (10 sec) • Solid green during app load (1-4 minutes, depending on system configuration) • Flashing green when ready 	Blinking red/green: M-CPU is in a fault state. Power cycle may recover; otherwise, contact technical support.

15. Re-attach the cables that were removed in Step 2 and replug the AxLink connector.
16. Execute a test switch to be sure the system is working correctly.

Setting the CPU Clock

IMPORTANT: The following steps are not optional. They must be completed to set the date and time information on the CPU's clock.

1. Open the System Configuration interface (type the integrated Master's IP address in the address bar of the browser and press the Enter key).

NOTE: The IP address is available through the Control Panel LCD menu: *Function/Setup Options/Master Info/IP Address*.

2. From the *Network* drop-down menu, select **Date / Time** (FIG. 137):

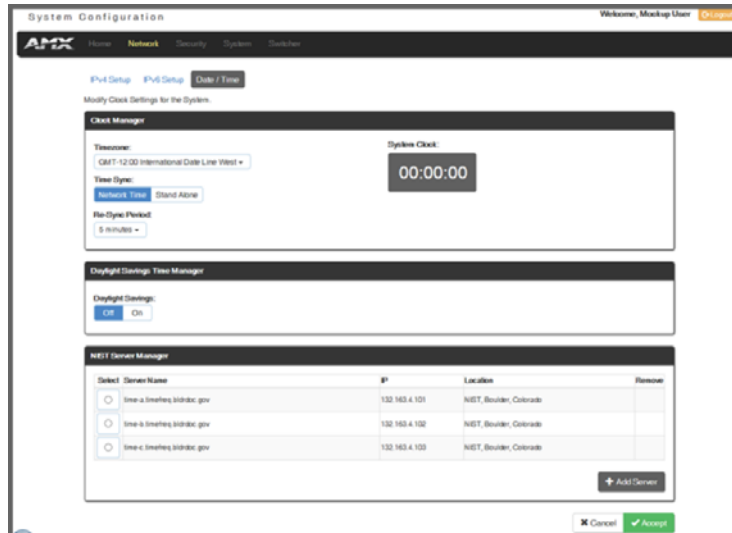

FIG. 137 System Configuration interface - Network → Date / Time

3. Under *Clock Manager*, select the desired **Timezone** from the drop-down list.
4. Under *Time Sync*, select either **Network Time** or **Stand Alone** (if Stand Alone, enter additional information).
5. Under *Re-Sync Period*, select the desired length of time from the drop-down list.
 - **Optional** – under *Daylight Savings Time Manager*, select either **Off** or **On** (if **On**, select additional options).
 - **Optional** – Under *NIST Server Manager*, select a **Server Name** (or add a server using the **+Add Server** button on the right).
6. Click **Accept**.

CPU Troubleshooting

First: Check all cable connections, check the System Status LED, and execute a test switch.

If the System Status LED is still not illuminated or the test switch does not work:

Remove and re-seat the CPU board to see if the CPU establishes the connection.

If the System Status LED on the CPU does not display normal indications:

Contact technical support (see page 80).

Appendix C - DGX_SHELL Commands

Overview

The Enova DGX 100 Series Switcher supports a number of shell (command-line interpreter) commands for a variety of functions, both basic and advanced.

- DGX_SHELL commands are case sensitive.
- All commands in the DGX_SHELL require an Enter to execute.
- Enter `help` or `?` to display a list of the commands supported in the DGX_SHELL.
- Enter `help <command>` for detailed usage and options on a specific command.
- Enter `help -v` to display all commands and descriptions.
- The DGX_SHELL interface does not use an automatic timeout.
- The DGX_SHELL interface is the default terminal emulation interface. BCS commands can be entered either through the "bcs" DGX_SHELL command (see page 250) or by exiting the DGX_SHELL and beginning a BCS interface (see the instructions on page 248).
- During firmware upgrades, the prompt changes to "(upgrading) DGX_SHELL>" and some commands will not be accessible until the upgrade is complete. (Use the "help" command to display accessible commands.)

Although the Help file lists all of the DGX_SHELL commands available for the Enova DGX Switcher, only information on the basic commands (those most useful during installation and setup) are provided in this appendix. The remaining commands (which are also listed in the Help file) are used mainly by technical support for troubleshooting. For additional information on any of the advanced commands, contact www.amx.com/techsupport.

CAUTION: *Incorrect use of advanced DGX_SHELL commands has the potential to alter the operation of the system. We recommend that advanced commands only be entered in conjunction with instructions from technical support.*

Entering the DGX_SHELL Terminal Interface

1. Use a null modem serial cable to connect a PC to the Control port (RS-232 serial) on the enclosure (pinout for PC to enclosure: 5 GND to 5 GND, 2 RXD to 3 TXD, and 3 TXD to 2 RXD).
2. Open NetLinx Studio (v4.0 or later).
3. Select Tools/Terminal Session (if you use another terminal emulation program, be sure to set the COM port and the communication settings per Step 4). The Terminal Window Communication Settings dialog opens (FIG. 138):

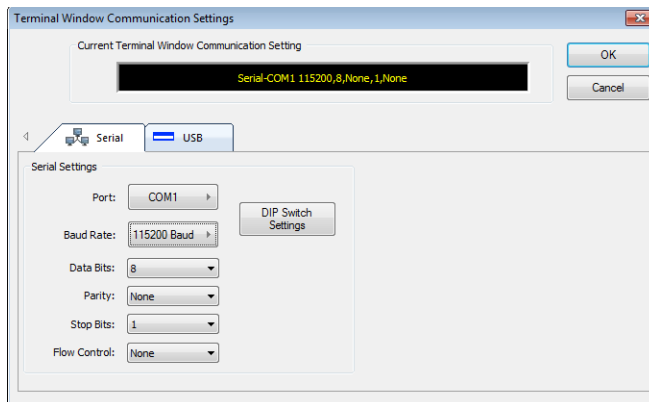

FIG. 138 NetLinx Studio - Terminal Window Communication Settings dialog

4. Set the COM port and the Serial Settings (Enova DGX 100 Series default settings: 115200 Baud / 8 / None / 1 / None).
5. Click **OK**. The Terminal window opens (FIG. 139):

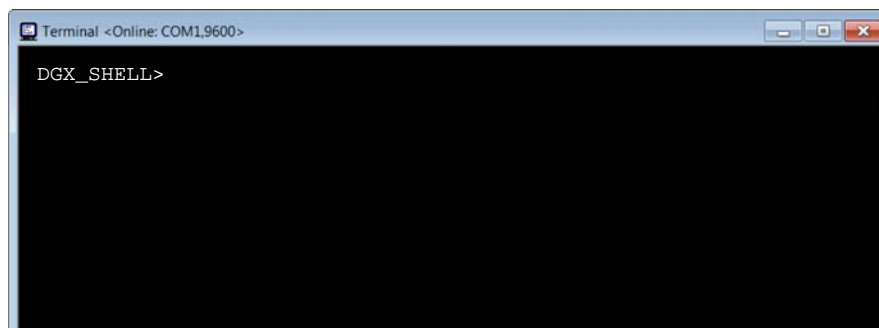

FIG. 139 NetLinx Studio - Terminal Window Communication Settings dialog

NOTE: If the terminal is open while the Switcher is booting, the terminal window displays status for firmware, hardware, and Ethernet ports. If the terminal is opened after the switcher has completed the boot process, the terminal window is blank. In either case, press ENTER to display the DGX_SHELL prompt and begin entering DGX_SHELL commands.

- At the prompt (DGX_SHELL>), type the command and press the Enter key.

Switching Between DGX_SHELL and BCS Interfaces

- From the DGX_SHELL prompt, type "bcs" followed by <enter> and enter the BCS interface.
- Enter BCS command(s). (For information on BCS commands, see the *Basic Control Structure Protocol Programming Guide* at www.amx.com.)
- Press CTRL+C to exit the BCS interface and return to the DGX_SHELL interface.

NOTE: In order to be able to send a Control Character (i.e., CTRL+C), Control Characters must be enabled for your Terminal (see instructions on page 210).

Product to Board Slot Correspondence

When a board slot is the target in a DGX_SHELL command, the command specifies BCPx, where x is the board slot number. To determine the number of the correct board slot to enter in this command, see the following table which provides board slot to product correspondence for Enova DGX Switchers. Note that the board slot numbering starts with the first input board and continues through the output boards.

NOTE: For targets that need to pinpoint the specific channel on a board, use BCPx:y, where the variable y = 0, 1, 2, or 3 (i.e., 0 = the first input or output channel on the board, 1 = the second channel, 2 = the third channel, and 3 = the fourth channel).

NOTE: Board slot numbering does not include boards in the expansion board slots.

Product to Board Slot Correspondence			
Product	Board Orientation	Board Slot #	Connector Numbers
Enova DGX 800	Horizontal	1	Inputs 1-4
		2	Inputs 5-8
		3	Outputs 1-4
		4	Outputs 5-8
Enova DGX 1600	Horizontal	1	Inputs 1-4
		2	Inputs 5-8
		3	Inputs 9-12
		4	Inputs 13-16
		5	Outputs 1-4
		6	Outputs 5-8
		7	Outputs 9-12
		8	Outputs 13-16
Enova DGX 3200	Vertical	1	Inputs 1-4
		2	Inputs 5-8
		3	Inputs 9-12
		4	Inputs 13-16
		5	Inputs 17-20
		6	Inputs 21-24
		7	Inputs 25-28
		8	Inputs 29-32
		9	Outputs 1-4
		10	Outputs 5-8
		11	Outputs 9-12
		12	Outputs 13-16
		13	Outputs 17-20
		14	Outputs 21-24
		15	Outputs 25-28
		16	Outputs 29-32

Product to Board Slot Correspondence			
Product	Board Orientation	Board Slot #	Connector Numbers
Enova DGX 6400	Horizontal	1	Inputs 1-4
		2	Inputs 5-8
		3	Inputs 9-12
		4	Inputs 13-16
		5	Inputs 17-20
		6	Inputs 21-24
		7	Inputs 25-28
		8	Inputs 29-32
		9	Inputs 33-36
		10	Inputs 37-40
		11	Inputs 41-44
		12	Inputs 45-48
		13	Inputs 49-52
		14	Inputs 53-56
		15	Inputs 57-60
		16	Inputs 61-64
		17	Outputs 1-4
		18	Outputs 5-8
		19	Outputs 9-12
		20	Outputs 13-16
		21	Outputs 17-20
		22	Outputs 21-24
		23	Outputs 25-28
		24	Outputs 29-32
		25	Outputs 33-36
		26	Outputs 37-40
		27	Outputs 41-44
		28	Outputs 45-48
		29	Outputs 49-52
		30	Outputs 53-56
		31	Outputs 57-60
		32	Outputs 61-64

NOTE: In the Enova DGX 6400, the numbering for input boards starts at the top left of the enclosure going down half way, continuing at the top right of the enclosure going down; the output boards repeat the same pattern in the lower portion of the enclosure.

Basic DGX_SHELL Commands

The DGX_SHELL commands listed in the table below can be sent directly to the Enova DGX Switcher via any standard emulation terminal once you enter the DGX_SHELL.

- DGX_SHELL commands are case-sensitive.
- BCPU is the acronym for Board CPU, and AIE is the acronym for Audio Insert/Extract (board).
- At the DGX_SHELL prompt, type `help` or a question mark (?) and press the Enter key to access the Help Menu, which displays all of the DGX_SHELL commands, including the basic ones described in the table below:

Basic DGX_SHELL Commands	
? help	Either of these commands displays all of the supported commands: those listed in this table, plus advanced commands for troubleshooting (for technical support; see page 80).
help -a help -v	The <code>help -a</code> command displays a list of all available commands, their descriptions, and detailed usage. The <code>help -v</code> (verbose) command lists the commands and their descriptions. Usage: <code>help {-a}{-v}</code> Note: <i>-a and -v can also be used with the ?.</i>
help <cmd>	Either of these commands displays detailed usage and options for the command specified. Usage: <code>help {<command>} or ? {<command>}</code>
exit	Exits the shell session.

Basic DGX_SHELL Commands (Cont.)	
announce	<p>This command is used to display AIPNet Ethernet messages.</p> <p>Usage: announce</p> <p>Example: DGX_SHELL> announce Input Board 1: BCPU1 MAC Address - 02.D0.47.01.03.00 IP Address - 0.0.0.0 Position - Card Hub Slot Address - 0 Channel ID - 0 SW Cfg Stat - Success Input Board 3: BCPU3 MAC Address - 02.D0.47.01.04.00 IP Address - 0.0.0.0 Position - Card Hub Slot Address - 2 Channel ID - 0 SW Cfg Stat - N/A Output Board 1: BCPU9 MAC Address - 02.D0.47.02.0B.00 IP Address - 0.0.0.0 Position - Card Leaf Slot Address - 9 Channel ID - 0 SW Cfg Stat - N/A Input Expansion Board: EXPIN Output Expansion Board: EXPOUT</p>
bcs	<p>This command is used to send BCS commands via the DGX_SHELL interface.</p> <p>Usage: bcs {<bcs_syntax_cmd>} <bcs_syntax_cmd> = bcs syntax command string</p> <ul style="list-style-type: none"> • If sending BCS commands over Telnet – You must first enter the BCS command environment before sending BCS commands. At the DGX_SHELL prompt, type: <code>bcs <enter></code> and then type the BCS command. The Telnet connection does not allow in-line BCS commands while in the DGX_SHELL interface (e.g., <code>DGX_SHELL> bcs CL1I6024T {INVALID}</code>). • For instructions on switching between the DGX_SHELL and BCS interface, see page 248.
channel	<p>This command is used to read or write video settings for the designated channel (using the command alone results in a dump of the entire system).</p> <ul style="list-style-type: none"> • The channel index (BCPUx:y) relates to the physical input or output port on an input or output board, whose hardware numbering is complex due to the varying orientation of the boards on different Enova DGX products (see the "Product to Board Slot Correspondence" table on page 248). We recommend using the variables <code>ix</code> and <code>ox</code> to specify the desired input and output channels (e.g., enter channel <code>-v I25</code> for Input 25). • To persist the <code>-m</code> scaler change to flash (for power on scaler setting), the <code>-p</code> (persist) must also be sent. <p>Usage: channel {-a}{-d <hex_string>}{-m <hex_string>}{-o <hex_string>}{-p}{-s <hex_string>}{-v} {Ix Ox BCPU BCPUx BCPUx:y BCPUx:y:z}</p> <p>Options: -a ar_policy <HEX_BYTE> -d flash_dtd <HEX_DTD_STRING> -m mode <HEX_BYTE> 00 = Auto, 01 = Manual, 02 = Bypass -o override_dtd <HEX_DTD_STRING> -p persist -s sharpness <HEX_BYTE> -v verbose</p> <p>Target: BCPU BCPUx x = 1-32 (boardID) where x = 1-32 for Enova DGX 6400; x = 1-16 for Enova DGX 3200; x = 1-8 for Enova DGX 1600; x = 1-4 for Enova 800 BCPUx:y y = 0-3 (channel-hardware order) BCPUx:y:z z = 0-7 (port)</p> <p>Example 1: DGX_SHELL> channel -v BCPU19:0 Output: 9 (BCPU19:0:7) Video: 1920x1080p,59.9Hz Audio: 48 kHz, 16 bits DTD: 02 3A 80 18 71 38 2D 40 58 2C 45 00 00 00 00 00 00 1E AUX_MODE: 00 01 00 AUX_POLICY: 01 01 00 AUX_SHARPNESS: 02 01 00</p> <p>Example 2: DGX_SHELL> channel -m 02 BCPU7:0 [sets the scaler mode of BCPU7:0 to Bypass (02)] Output: BCPU7 Channel: 0 port :0 Video: 1920x1080p,60.0Hz DGX_SHELL> channel -p BCPU7 :0 [persists the power-on scaler mode to flash for BCPU7:0] Output: BCPU7 Channel: 0 port :0 Video: 1920x1080p,60.0Hz</p>

Basic DGX_SHELL Commands (Cont.)	
clear	This command is used to clear the terminal screen. Usage: clear
date	This command displays both run-time clock and system time information and the time of the last NTP (Network Time Protocol) update. <ul style="list-style-type: none"> rtc is the time held by the real time clock chip. The last updated is the beginning of unix time. system (system time) is the time known by the coldfire and is generated locally. Usage: date
echo	This command is used to print a string back to the terminal. Usage: echo "string" Example: DGX_SHELL> echo "Hello World!" Hello World!
history	This command is used to display a list of previously invoked commands. Usage: history
ifconfig	This command displays network interface information for private and public networks. Usage: ifconfig {-e <interface>} Interface: 0 (Private Network) or 1 (Public Network) Example: DGX_SHELL> ifconfig Ethernet Port 0 MAC 00:d0:47:01:10:4d link up state: 3 ipaddr 198.18.128.1 ipmask 255.255.0.0 gateway 198.18.0.1 Ethernet Port 1 MAC 00:d0:47:01:10:c3 link up state: 1 ipaddr 0.0.0.0 ipmask 0.0.0.0 gateway 0.0.0.0
log	This command is used to view and manage system logs. Contact Technical Support for usage.
logtail	This command is used to display log content and is filterable by logger, level, and number of entries. Usage: logtail {-s} {-l <level>} {-n <log name>} {-e <entries> -a} Options: -s Lists all loggers and levels. -l Filters output by log entry level. If not specified, defaults to DEBUG. 1 - FATAL -only fatal entries are output 2 - ERROR 3 - WARN 4 - INFO 5 - DEBUG - all entries are output -n Text name of logger(s) to tail. If not specified, defaults to all loggers. -e Outputs from most recent specified entries. If not specified, defaults to 0 (zero). -a (All) outputs from oldest entry
manage	This command allows the firmware version to be rolled back to either a previous version or the factory version. Usage: manage firmware Example: DGX_SHELL> manage firmware Current Version: 3.0.1 Previous Version: UNAVAILABLE Factory Version: UNAVAILABLE To install a firmware version: Enter P (Previous), F (Factory) or press return to cancel:

Basic DGX_SHELL Commands (Cont.)	
mxlog	<p>This command is used to set or view logging levels.</p> <p>Usage: <code>mxlog <logger> <level></code></p> <p>Loggers: main network aipnet sdCard shell fileTransfer C_lcspStack C_lcspDevice C_lcspMsg C_lcspTransport ftp config CommandManager Cage PortManager icsp_device oid_get oid_set oid_receive edid i2c srm initflags</p> <p>Levels: NONE (0) - no entries are logged FATAL (1) - only fatal are logged ERROR (2) - error and above logged WARN (3) - warning and above logged INFO (4) - info and above logged DEBUG (5) - all entries are logged</p> <p>Example: DGX_SHELL> mxlog Cage WARN Logger Cage level set to WARN (3)</p>
ping	<p>This command sends an echo request message to the target.</p> <p>Usage: <code>ping {n:} [BCPUx TXx RXx CENTERx PPIC EXPIN EXPOUT]</code></p> <p>Options: -n <count> number of echo request originated</p>
reboot	<p>This command can be used to reboot individual components or the system as a whole.</p> <p>DXLink Twisted Pair I/O Boards only - The <code>reboot</code> command can be used to reboot a specific endpoint connected to the board. Use the <code>y</code> variable to specify the connector attached to the endpoint (the DXLink Twisted Pair Module or Wallplate) you want to reboot.</p> <p>Usage: <code>reboot {abdf:iprsu}{MCPU}{BCPU BCPUx BCPUx:y BCPUx:y:z}{CENTER CENTERx}{PPIC}{EXPIN EXPINx}{EXPOUT EXPOUTx}</code></p> <p>Note: <i>EXPIN refers to an expansion board on the input side of the enclosure; EXPOUT refers to an expansion board on the output side.</i></p> <p>Options: -a ac power cycle -b backplane reset line -d delay <seconds> -f force (suppress prompting) -i immediate -p ppic reset line; hardware reboot of the PowerPic - toggle its MCLR (Hardware Master Clear) pin -r redundant reset (backplane reset line) hardware reboot of all boards except the CPU board - toggles their MCLR (Hardware Master Clear) pins -s staged reset -u subsystem <default=0 remote_power=1 local_transport=2 endpoint_transport=3 ethernet_phy=4 ethernet_switch=5 av_path=6></p> <p>Target: MCPU BCPU BCPUx x = 1-4 (DGX800), 1-8 (DGX1600), 1-16 (DGX3200), 1-32 (DGX6400) BCPUx:y y = 0-3 (channel-hardware order, variable only applies to DXLink Twisted Pair I/O Boards) BCPUx:y:z z = 0-7 (port) CENTER use for an Enova DGX 800/1600 or to target all centers in an Enova DGX 3200/6400 CENTERx where x = 1-4 for an Enova DGX 3200/6400 PPIC EXPIN (expansion board in the input section of the enclosure) EXPINx where x = 1-4 for an Enova DGX 6400 (expansion board in input section of enclosure) EXPOUT (expansion board in the output section of the enclosure) EXPOUTx where x = 1-4 for an Enova DGX 6400 (expansion board in output section of enclosure)</p>

Basic DGX_SHELL Commands (Cont.)	
reboot (Cont.)	<ul style="list-style-type: none"> If no specific targets are chosen, the command will apply to all possible targets. If <code>-r</code> is selected, a hardware line to all I/O boards is forced low then released, causing the boards to experience a hard MCLR (Hardware Master Clear). If <code>-s</code> is selected, in addition to having the main power supplies turned off, a hardware connection to the PowerPIC is forced low then released, causing the PowerPIC to experience a hard MCLR.
reset	<p>This command resets settings and other system data to their default values.</p> <p>Usage: <code>reset [options] <action></code></p> <p>Actions: <code>factory</code> (apply system default settings to MCPUs and BCPUs)</p> <p>Options: <code>--help</code>, <code>-h</code> (displays command usage information.)</p> <p>Note: <i>In elevated shell user levels, run <code>reset -h</code> to display information on additional options.</i></p> <p>Example: <code>reset factory</code> Apply defaults to MCPUs and BCPUs</p>
sc	<p>This command sends an ICSP Send Command to a Port of the 5002 device.</p> <p>Usage: <code>sc</code></p> <p>Actions: <code><port> <command></code> Destination Device Port and Command</p> <p>Example: <code>sc 1 AUDOUT_MUTE-ENABLE</code></p>
set	<p>This command displays a list of configuration variables indicating the current setting.</p> <ul style="list-style-type: none"> A variable's setting can be altered, except for the ones marked "# READONLY." "# VOLATILE" indicates that the value set will be reset to the default value if the MCPUs reboot. <pre> auto_setup_disabled=1,2,3,4 (DXLink Twisted Pair and DXLink Fiber only) bdf_writeprotect=ON shell_start_cmdstr_COM1= shell_start_cmdstr_COM2= shell_start_cmdstr_telnet= com1_baudrate=115200 com2_baudrate=115200 com3_baudrate=115200 com1_data_bits=8 com2_data_bits=8 com1_stop_bits=1 com2_stop_bits=1 com1_parity=none com2_parity=none mcpu_eth1_enabled=DISABLE mcpu_eth1_hostname= mcpu_eth1_dhcp_enabled=DHCP mcpu_eth1_ip_address=0.0.0.0 mcpu_eth1_subnet_mask=0.0.0.0 mcpu_eth1_default_gateway=0.0.0.0 BCPUx_debug_enabled=none BCPUx_ip_address=10.0.0.64 BCPUx_mac_address=02:d0:47:00:10:4d # READONLY BCPUx_syslog_enabled=OFF BCPUx_syslog_server_port=514 BCPUx_syslog_server_ip_address=0.0.0.0 BCPUx_syslog_server_mac_address=00:00:00:00:00:00 BCPUx_bg_vsync_disabled=OFF BCPUx_dxlink_force_uni_mode_en=none BCPUx_dxlink_mode_actual=1(Link-lost),2(Bi),3(Lin# READONLY ink-lost) BCPUx_auto_setup_disabled=none PPIC_ethernet_mirroring=OFF # VOLATILE PPIC_ethernet_mirrored_ports=none # VOLATILE PPIC_icslan_multiport=private # VOLATILE </pre> <p>Usage: <code>set {-d}{-v}{<name>}{=}{value}</code></p> <p>Options: <code>-d</code> default Restore the variable's default value. <code>-v</code> verbose Print the variable's description and syntax.</p> <p>Target (target names contain a following underscore): <code>BCPU_</code> <code>BCPUx</code> x = 1-4 (DGX800), 1-8 (DGX1600), 1-16 (DGX3200), 1-32 (DGX6400) <code>CENTER</code> use for an Enova DGX 800/1600 or to target all centers in an Enova DGX 3200/6400 <code>CENTERx</code> where x = 1-4 for an Enova DGX 3200/6400 <code>PPIC_</code> <code>EXPIN</code> (expansion board in the input section of the enclosure) <code>EXPINx</code> where x = 1-4 for an Enova DGX 6400 (expansion board in input section of enclosure) <code>EXPOUT</code> (expansion board in the output section of the enclosure) <code>EXPOUTx</code> where x = 1-4 for an Enova DGX 6400 (expansion board in output section of enclosure) <code>EXPCPU_</code></p>

Basic DGX_SHELL Commands (Cont.)	
show	<p>This command displays system information.</p> <p>Usage:</p> <pre>show {aie bdf pop status stats version} {BCPU BCPUx BCPUx:y BCPUx:y:z} {CENTER CENTERx} {PPIC} {EXPIN EXPINx} {EXPOUT EXPOUTx}</pre> <p>When displaying information for BCPUs, DXLink Fiber Boards will report as "DxLinkFiber" for Duplex Boards and "DxLinkSimplex" for Simplex Boards.</p>
splash	<p>This command prints splash screen information.</p> <p>Usage:</p> <pre>splash {i:v:}</pre> <p>Options:</p> <pre>-i <PID_number> 1,2,3,4,5,6,7,9 supported -v <verbosity> levels 1-3</pre> <p>Example 1:</p> <pre>DGX_SHELL> splash [1:Enclosure] AMX Enova DGX 3200 [2:Storage Blocks] cleared [3:Communication Interfaces] count = 5 [4:Hardware Boards] detected [5:VM Configuration] count = 5 [6:Power System] good [7:System Sensors] detected [9:BCPU Info]</pre> <p>Example 2:</p> <pre>DGX_SHELL> splash -i1 -v2 [1:Enclosure] AMX Enova DGX 3200 [host software] 1.0.8 [hardware driver] 3.0.0.3_20150916 D [build date] 2015-09-16 11:00:02 [pld version] A1 [fbpld version] A0 [xnet address] 0x110c3 [fp xnet address] 0x157c7 [nvram status] valid.. user preferences restored [nvram magic] 0xdedafabb [target id] 0 [hardware id] 0 [srm version] gen: 1 version: 5 build: 1</pre>
su	<p>This command changes the user privilege level from basic (default) to Super User, enabling advanced commands.</p> <p>Usage:</p> <pre>su {<system>} {<password>}</pre> <p>Example:</p> <pre>su enova 12amx34</pre> <p>Super User privileges are lost and only basic DGX_SHELL commands are available on closing the terminal.</p>
switch	<p>This command graphically displays a matrix switching table with outputs on the top and inputs on the left, indicating the routing state of switches.</p> <p>Usage:</p> <pre>switch <VM></pre> <p>VM (Virtual Matrix):</p> <pre>0 - Video with embedded audio matrix (default switching matrix) showing 8x8, 16x16, 32x32, or 64x64 1 - Video only matrix showing 8x8, 16x16, 32x32, or 64x64 2 - Audio only matrix showing 16x16, 24x24, 40x40, or 80x80</pre> <p>Example:</p> <pre>DGX_SHELL> switch 1</pre> <p>outputs a matrix similar to the example matrix switching table in FIG. 140 on page 255.</p>
unset	<p>This command returns a variable to its default state.</p> <p>Usage:</p> <pre>unset <target> <variable></pre> <p>Example:</p> <pre>DXG_SHELL> unset BCPU10_auto_setup_disabled BCPU10_auto_setup_disabled=none</pre>
version	<p>This command displays the system component versions.</p> <p>Usage:</p> <pre>version</pre> <p>Example:</p> <pre>DGX_SHELL> version AMX Enova DGX 3200 Copyright Harman International, AMX by Harman 2015 Serial: 000000000 Firmware: Bootloader: 1.0.8 Application: 3.0.0.3_20150916 System: 3.0.1 Hardware: Target ID: 0.0 System ID: 0x01</pre>

		VM 1															
		OUTPUTS															
		1	2	3	4	5	6	7	8	9	10	11	12	13	14	15	16
I N P U T S	1
	2	..	><
	3	><	..	><
	4	><	><	><	..	><	..
	5	><	><	><	..	><	><	><	><	..	><	..	><
	6
	7
	8
	9
	10
	11
	12
	13
	14
	15
	16

FIG. 140 DGX_SHELL switch command displays matrix switching status in a table (Enova DGX 1600 shown)

Appendix D - Telnet Communication with DGX CPU

Overview

One of the features of the Enova DGX 100 Series switchers is that, by default with auto-setup mode enabled, the entire DGX system (including all DXLink endpoints in auto-setup mode) only consumes a single public IP address. However the Enova DGX 100 Series switchers also have a secondary internal Ethernet port which can be enabled for diagnostics and/or control purposes. By default, this port is disabled, but may be enabled or disabled through either NetLinx Studio or through a serial connection to the DGX.

This Appendix covers methods for enabling, disabling, and confirming the setting of the Telnet connection to an Enova DGX 100 Series CPU. This Appendix does not cover Telnet connection with the NX Master or directly to DXLink Twisted Pair or DXLink Fiber endpoints. For NX Master Telnet commands, see page 19. For information on Telnetting directly to DXLink endpoints, see page 122 (DXLink Twisted Pair) or page 151 (DXLink Fiber).

NOTE: *The BCS Tunnel (port 15000) is not supported in Enova DGX 100 Series Digital Media Switchers.*

Enabling the Telnet Session

The Telnet session (via internal Ethernet port) may be enabled through either NetLinx Studio or through a serial connection to the DGX. Whenever this port is enabled, the DGX consumes two public IP addresses.

IMPORTANT: *Toggling IP settings (DHCP or Static IP) or enabling/disabling the Telnet internal Ethernet port via a serial connection requires rebooting the DGX for the change(s) to take effect. Rebooting is not required when adjusting these settings via NetLinx Studio.*

Enabling the Telnet session via NetLinx Studio:

1. Open NetLinx Studio and navigate to the OnLine Tree.
2. Right-click on the Enova integrated Master (00000 device) and select TELNET Window/Launch TELNET Window via NetLinx Studio. The terminal opens.
3. Type the following command string <with appropriate values for your installation>:
For DHCP Telnet - `send_command 5002:1:1, "'IFCONFIG-1,UP,D,hn=<hostname>' "`
For Static IP Telnet - `send_command 5002:1:1, "'IFCONFIG-1,UP,S,ip=<IP Address>,gw=<Default Gateway>,mask=<Subnet Mask>,hn=<Hostname>' "`
 Example:
`send_command 5002:1:1, "'IFCONFIG-1,UP,S,ip=10.103.4.155,gw=10.103.4.1,mask=255.255.255.0, hn=DGX_Telnet' "`
4. Launch the Telnet session (see section on the following page).

Enabling the Telnet session via DGX_SHELL Commands

Settings after `mcpu_eth1_dhcp_enabled` are not required unless enabling Telnet with a Static IP address.

1. Enter the DGX_SHELL terminal interface (see instructions on page 273).
2. Send the DGX_SHELL commands to enable Telnet <with appropriate values for your installation>:
`DGX_SHELL> set mcpu_eth1_enabled=ON`
`DGX_SHELL> set mcpu_eth1_hostname=<Hostname>`
`DGX_SHELL> set mcpu_eth1_dhcp_enabled=<either DHCP or STATIC>`
`DGX_SHELL> set mcpu_eth1_ip_address=<IP Address>`
`DGX_SHELL> set mcpu_eth1_subnet_mask=<Subnet Mask>`
`DGX_SHELL> set mcpu_eth1_default_gateway=<Default Gateway>`
3. Reboot the Enova DGX.
4. Launch the Telnet session (see section on the following page).

Using the Telnet Connection

With the Telnet connection enabled, the Telnet session can be launched and DGX_SHELL (default) or BCS commands can be used in the terminal window.

Launching the Telnet Session

Commands sent over the Telnet session rather than a serial connection may be markedly slower due to the difference in speeds possible from a direct connection to that of TCP over a network.

1. Open a terminal emulation program.
2. Configure the terminal session with the following settings:
 - **Connection type / Service** – Telnet
 - **Host Name / Address** – <Telnet IP Address>
 - **TCP Port** – 23
3. Open the terminal window.

4. Press ENTER at the DGX_SHELL> prompt and begin sending commands (see DGX_SHELL commands on page 273 or the *Basic Control Structure Protocol Programming Guide* at www.amx.com).

NOTE: You must first enter the BCS command environment before sending BCS commands. At the DGX_SHELL> prompt, type: `bc` <enter> and then type the BCS command. The Telnet connection does not allow in-line BCS commands while in the DGX_SHELL interface (e.g., `DGX_SHELL> bcs CL1I6024T {INVALID}`).

Telnet Default Communication

By default, the Telnet session starts in the DGX_SHELL and will immediately accept DGX_SHELL commands (see page 273).

Setting the Telnet Connection to Start in BCS

1. Launch the Telnet session.
2. Type the following DGX_SHELL command string:
`DGX_SHELL> set shell_start_cmdstr_telnet=bc`
3. Close the Telnet session.
4. Open a new Telnet session and press <enter>.
5. Begin entering BCS commands (for BCS commands, see the *Basic Control Structure Protocol Programming Guide* at www.amx.com).

Setting the Telnet Connection to Start in the DGX_SHELL

1. Launch the Telnet session.
2. Press CTRL+C to exit the BCS environment and enter the DGX_SHELL.
3. Type the following DGX_SHELL command string:
`DGX_SHELL> unset shell_start_cmdstr_telnet`
4. Close the Telnet session.
5. Open the Telnet session and press <enter>.
6. Begin entering DGX_SHELL commands (for DGX_SHELL commands, see page 273).

Confirming the Telnet Session Starting Environment

1. From the DGX_SHELL, type the following DGX_SHELL command:
`DGX_SHELL> set`
2. Scroll through the command's output for the line:
`shell_start_cmdstr_telnet=`
3. Confirm that the setting = <blank> (which means DGX_SHELL) or <bc>.

Disabling the Telnet Session

The Telnet session (via internal Ethernet port) may be disabled through either NetLinx Studio or through a serial connection to the DGX. With this port disabled and with auto-setup mode enabled, the DGX consumes one public IP address.

IMPORTANT: *Toggling IP settings (DHCP or Static IP) or enabling/disabling the Telnet internal Ethernet port via a serial connection requires rebooting the DGX for the change(s) to take effect. Rebooting is not required when adjusting these settings via NetLinx Studio.*

Via NetLinx Studio

1. Open NetLinx Studio and navigate to the OnLine Tree.
2. Right-click on the Enova integrated Master (00000 device) and select TELNET Window/Launch TELNET Window via NetLinx Studio. The terminal opens.
3. Type the following command string <with appropriate values for your installation>:
 - If using Static IP – `send_command 5002:1:1, "'IFCONFIG-1,DOWN,S,<Default Gateway>'"`
 - If using DHCP – `send_command 5002:1:1, "'IFCONFIG-1,DOWN,D,gw=<Default Gateway>'"`

Via DGX_SHELL Command

1. Enter the DGX_SHELL terminal interface (see instructions on page 273).
2. Send the DGX_SHELL command to disable Telnet:
`DGX_SHELL> unset mcpu_eth1_enabled`
3. Reboot the Enova DGX.

Confirming Telnet Session is Enabled/Disabled

The Telnet session's status (enabled/disabled) may be checked through either NetLinx Studio or through a serial connection to the DGX.

Via NetLinx Studio

1. Open NetLinx Studio and navigate to the OnLine Tree.
2. Right-click on the Enova Integrated Master (000000 device) and select TELNET Window/Launch TELNET Window via NetLinx Studio. The terminal opens.
3. Type the following command string into the terminal:
`SEND_COMMAND 5002:1:1, "'?ifconfig-1'`
4. Scroll through the output response (e.g., `IFCONFIG-1,UP,S,ip=10.103.4.155,gw=10.103.4.1,mask=255.255.255.0,hn=DGX_Telnet`) and look for a setting of either `UP` (Telnet enabled) or `DOWN` (Telnet disabled).

Via Serial Connection

1. Enter the DGX_SHELL terminal interface (see instructions on page 273).
2. Send the following DGX_SHELL command:
`DGX_SHELL> set`
3. Scroll through the command's response and look for the line:
`mcpu_eth1_enabled=<ENABLE or DISABLE>.`

Appendix E - Upgrading/Downgrading the System

Overview

The instructions in this section describe the process for upgrading an Enova DGX 8/16/32/64 Digital Media Switcher to an Enova DGX 100 Series Digital Media Switcher.

These instructions also cover the process for downgrading an Enova DGX 100 Series Digital Media Switcher to an Enova DGX 8/16/32/64 Digital Media Switcher.

NOTE: *These procedures can be done while the enclosure is in a rack, but the system must be powered down.*

For a list of differences between an Enova DGX 8/16/32/64 system and a 100 Series system (including required changes for programming code), see the "Enova DGX 100 Series and Enova DGX 8/16/32/64 Differences" section on page 27.

Upgrade Sequence Overview

While you can upgrade the system in a different sequence than the instructions provided below, this sequence is the most straightforward method for upgrading your system and associated endpoints. Note that endpoints may be inaccessible after CPU upgrade until the enclosure upgrade has been completed.

1. Upgrade any Solecis Digital Switchers (see below).
2. Upgrade the front control panel (see page 260).
3. Replace the current (8/16/32/64) CPU Board with an Enova DGX 100 Series CPU (see page 261).

NOTE: *If ASB boards will be used in the upgraded system, install them prior to applying power to the system for the first time with a 100 Series CPU installed.*

4. Upgrade the enclosure (see page 264).
5. Upgrade any DXLink Twisted Pair or DXLink Fiber endpoints (see page 265).

Upgrading a Solecis Digital Switcher

Upgrading firmware on a Solecis Digital Switcher requires downloading the latest firmware files from www.amx.com and using NetLinx Studio to transfer the files to the target switcher.

IMPORTANT: *Before connecting a Solecis Digital Switcher to a DXLink Twisted Pair Input Board in an Enova DGX 100 Series Digital Media Switcher, both the Solecis unit and all DXLink Twisted Pair boards must be upgraded with the latest available firmware versions. Solecis units must be upgraded before connecting a unit to an upgraded input board.*

1. Download and unzip the "Solecis Digital Switcher Firmware" .zip file:
 - a. Navigate to the Solecis switcher's product page at www.amx.com.
 - b. Locate the Firmware Files section on the right side of the page and select the .zip file for download.
 - c. Unzip and open the downloaded file folder.

Optional – Open and review the Readme file.

2. Launch NetLinx Studio and open the OnLine Tree.
3. In the OnLine Tree, right-click in the Workspace Bar and select **Refresh System OnLine Tree**. Verify that the Solecis switcher is listed in the OnLine Tree.
4. Select Tools/Firmware Transfers/Send to NetLinx Device. The *Send to NetLinx Device* dialog appears (FIG. 141):

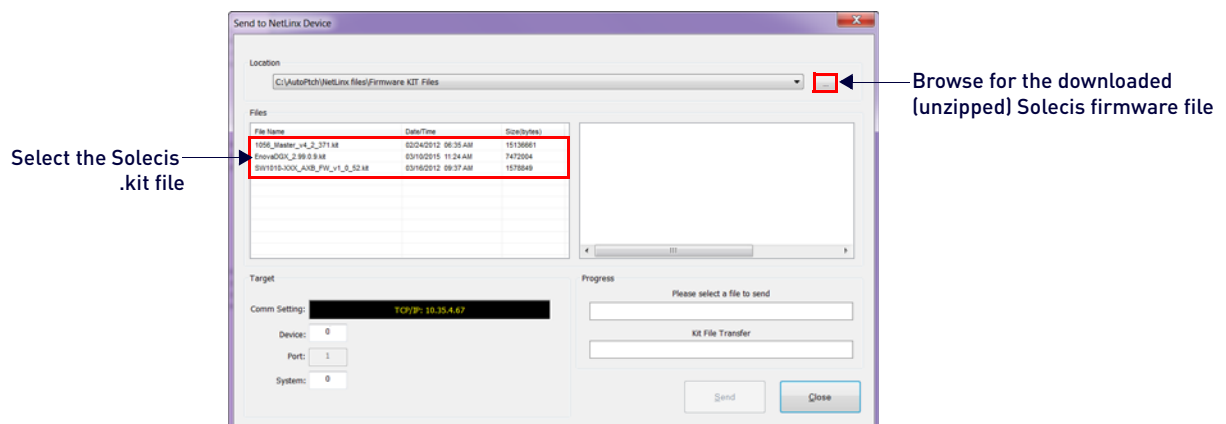

FIG. 141 NetLinx Studio - Send to NetLinx Device dialog

5. Click the Browse button (...) and navigate to the downloaded file.
6. Select the file for the Solecis switcher (.kit file). Click **Send**.
7. Click **Close** once the download process is complete.

8. Reboot the Solecis switcher.
9. In the OnLine Tree, right-click on the switcher and select **Refresh System**. This establishes a new connection and refreshes the device list and their firmware versions in your system.

NOTE: Once the process is complete, you can upgrade the remaining firmware files. All device files must be kept at compatible firmware versions for proper operation. Therefore, all files should be used when upgrading any firmware associated with the Integrated switchers.

Upgrading the Control Panel

IMPORTANT: The new control panel functionality provided by the Enova DGX 100 Series CPU will not be available until the CPU is replaced. The Enova DGX must remain powered during the upgrade process.

1. Turn off AC power to the enclosure. Make sure none of the power supply LEDs are illuminated.
2. Loosen the four captive screws on the control panel (FIG. 142):

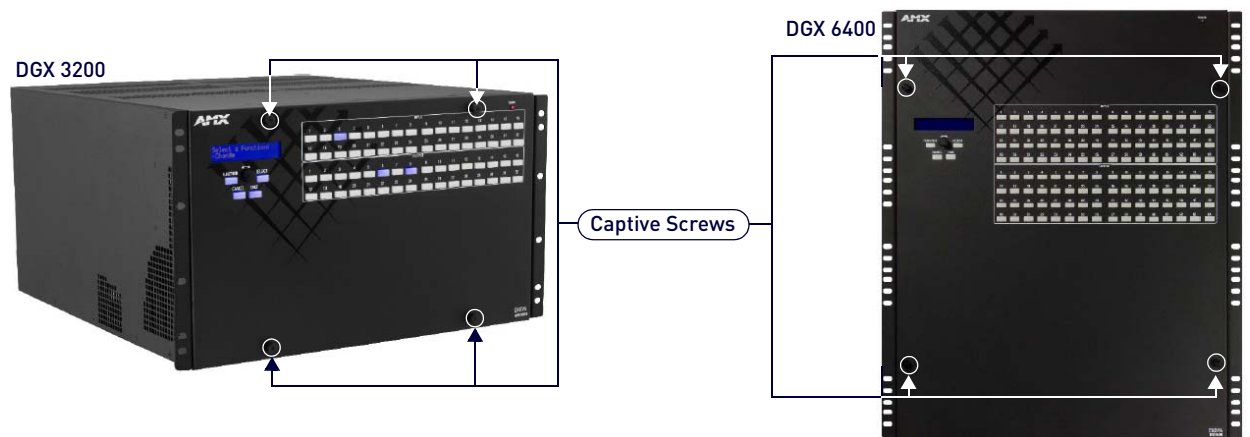

FIG. 142 Loosen 4 captive screws [screw location varies slightly depending on model]

3. Slowly pull the control panel straight out from the enclosure. Support control panel during upgrade.

IMPORTANT: Do not remove the control panel's power cable from its connector.
4. Apply power to the enclosure.
5. Connect a null modem serial cable to the serial (DB-9) port on the control panel (FIG. 143):

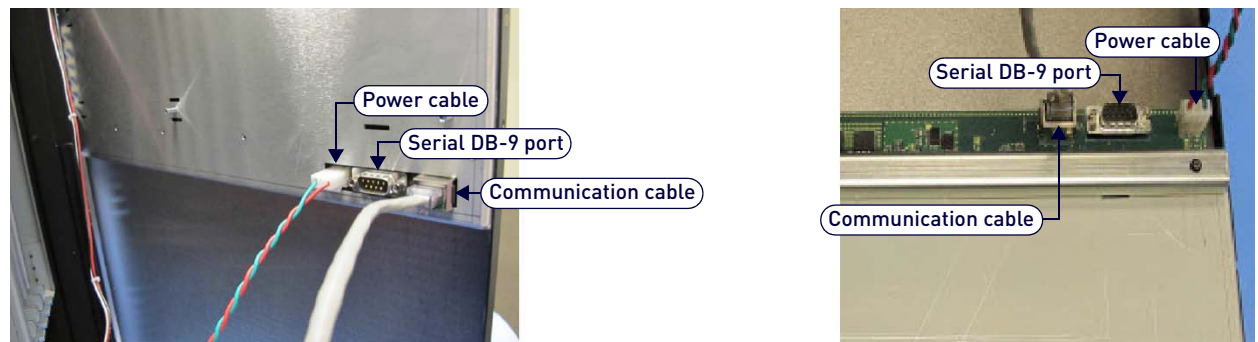

FIG. 143 Control panel cables/ports (appearance varies slightly depending on model)

6. Connect the other end of the serial cable to a PC.
7. Download and unzip the "Enova DGX 100 Series Front Panel Firmware" .zip file:
 - a. Navigate to the Enova DGX 100 Series product pages at www.amx.com.
 - b. Locate the Firmware Files section on the right side of the page and select the .zip file for download.
 - c. Unzip and open the downloaded file folder.
 - d. Click the setup.exe file to install the AppCodeLoader program on your PC or device.
8. Open the AppCodeLoader program (FIG. 144):

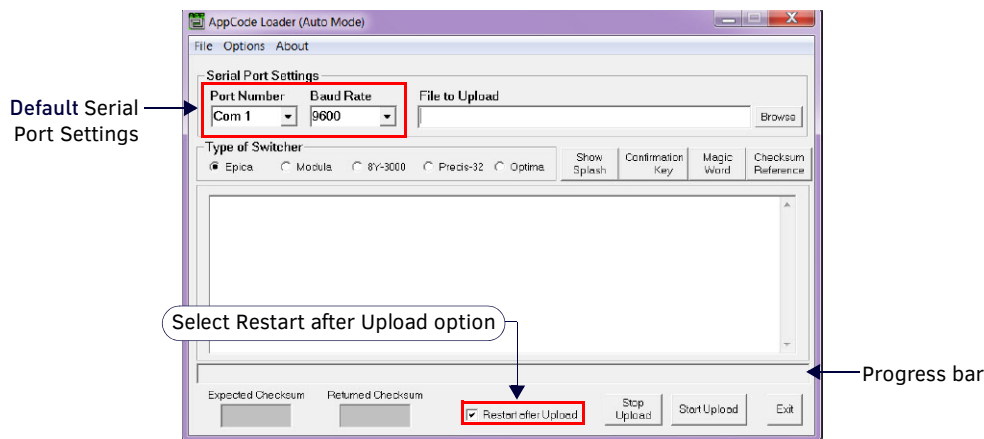

FIG. 144 AppCode Loader

9. Set Serial Port Settings for your system:
 - a. Set Baud Rate to 9600
 - b. Set Com port per your system's requirements (1-9 are available options)
10. Browse for the "image-v2.x.x.enc" file (downloaded from www.amx.com) to upload. The "Restart after Upload" check box must be selected.
11. Click the "Start Upload" button and wait for the upload to finish. The [Expected Checksum] and [Returned Checksum] will match when the upload is complete (update takes about 3 minutes and says "Upload Successful!" when complete).

NOTE: If the Appcode Loader fails to start the upload, check your Com port and cable connection and click Start Upload again.

NOTE: After "Start Upload" the program changes the baud rate to 57600 and puts the front panel in IOS mode indicated in the text in the app window, and also on the front panel itself. The front panel LCD shows "IOS Mode Contact Tech Support."

12. Click Exit.
13. Turn off AC power to the enclosure. Make sure none of the power supply LEDs are illuminated.
14. Replace control panel and tighten the four captive screws.
15. Apply power to the enclosure.
16. **Required** – Complete the directions on the following pages to upgrade the CPU, then the enclosure.

TIP: The system's IP address will be available for 100 Series CPU boards through the control panel's LCD menu: Function/Setup Options/Master Info/IP Address. Enter the system's IP address into a browser on a PC or other device on the same network as the switcher to launch the System Configuration interface (see page 74).

Removing Current CPU Board and Installing 100 Series CPU Board

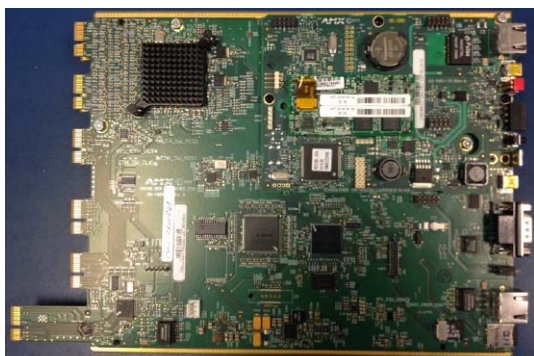

FIG. 145 Enova DGX 100 Series CPU board (top view)

CAUTION: Do not remove CPU board until you are ready to install the replacement, unless directed to do so by technical support.

Important Information for CPU Upgrade from 8/16/32/64 to 100 Series

- Do not transfer SD cards from the currently installed CPU into the 100 Series CPU. SD cards from Enova DGX 8/16/32/64 CPUs and 100 Series CPUs have different functions.
- CPU upgrade status will not show on the control panel unless the control panel has been upgraded prior to the CPU upgrade (see page 260).
- Epica DGX SC Optical Boards are not supported within the 100 Series platform; therefore, these boards must be removed prior to using the new CPU.

- After the CPU is upgraded to 100 Series, some boards may not power up. This is normal behavior for boards with firmware that does not match 100 Series compatibility. Upgrade the enclosure to regain full board power up.
- Endpoint devices bound to the replaced integrated Master (DGX 8/16/32/64 CPU) via TCP/UDP connection scheme are not detectable by the new integrated Master (DGX 100 Series CPU) until the new Master is configured for the IP address used by the previous Master. (NDP devices appear in NetLinX Studio's OnLine Tree as unbound devices.)
- When a 100 Series system powers up but contains I/O boards with incompatible firmware versions, the CPU will take longer than normal to boot (15 - 30 min, depending on cage size) and cause the System Status LED to blink red/green. This indicates that incompatible boards are present and need updating. To shorten the boot time and avoid the blinking red/green LEDs, the system can be booted with the boards unseated. Then, once the 5002 is online in about 4 min (indicated by blinking green LED), the boards may be added and upgraded per the normal kit transfer process.

Items Required

- Enova DGX 100 Series replacement CPU board
- Phillips #1 screwdriver
- ESD wristband and cord with an alligator clip

ESD WARNING: To avoid ESD (Electrostatic Discharge) damage to sensitive components, make sure you are properly grounded before touching any internal Enova DGX materials. Use an ESD wristband and cord with an alligator clip attached to a good ground source.

Removing and Replacing an DGX CPU board assembly:

NOTE: If SC Fiber Boards are in the enclosure, remove them before beginning the following instructions.

1. Turn off AC power to the enclosure. Make sure none of the power supply LEDs are illuminated.
2. Disconnect all cables connected to the CPU and power supplies.
3. Remove the screws from CPU faceplate: seventeen screws in the DGX 64, three screws in DGX 8/16/32 (FIG. 146):

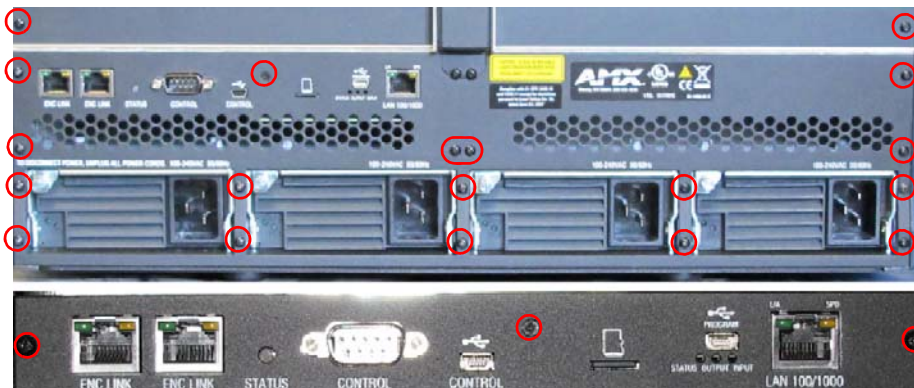

FIG. 146 Remove screws that hold faceplate

4. Remove the CPU faceplate and set aside.
5. Use the removal tab indicated to pull the CPU board assembly straight out of the enclosure (FIG. 147):

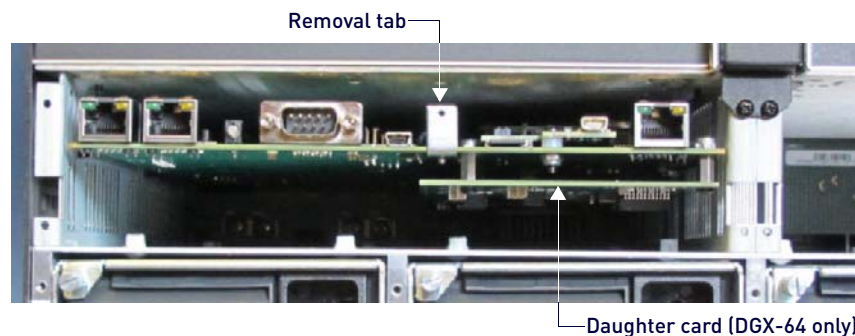

FIG. 147 Use removal tab to pull CPU straight out

6. Place the old CPU board in an ESD approved static shield bag and set aside.
7. Slowly slide the replacement CPU board into the empty slot, being careful to align the edges in the board guides along the insides of the slot (FIG. 148):



FIG. 148 Align CPU with board guides

8. Push on the CPU removal tab firmly enough for the board to make a good electrical connection (avoid pushing on the connectors). When the CPU board is fully inserted, its faceplate should sit flush with the back metal.
9. Set the old faceplate aside and attach new faceplate provided with CPU.

NOTE: If ASB boards will be used in the upgraded system, install them prior to applying power to the system for the first time with a 100 Series CPU installed. For more information about ASB boards, see *Audio Switching Boards - Rules for System Setup* on the following page.

10. Connect the enclosure (via the LAN 100/1000 port) to your public LAN.
11. Re-attach any cables that were removed in Step 2.
12. Apply power to the enclosure.
13. Check the CPU's System Status LED for indications of normal display (FIG. 149):



FIG. 149 System Status LED indicator (Enova DGX 800 shown)

LED Indicator	Indicates	Normal Display	Cautionary Display
System Status LED	System status	<ul style="list-style-type: none"> • Solid amber during boot load (10 sec) • Solid green during app load (1-4 minutes, depending on system configuration) • Flashing green when ready 	Blinking red/green: MCPU is in a fault state. Power cycle may recover; otherwise, contact technical support. (Systems with 100 Series CPU and I/O boards that have incompatible firmware use red/green blinking LED to indicate that enclosure/boards still require an upgrade.)

14. Wait for the 5002 device to come online (15 - 30 min, depending on enclosure size).

NOTE: For information about reducing boot time, see the "Important Information for CPU Upgrade from Enova DGX 8/16/32/64 to 100 Series - section on page 261.

15. If input and/or output boards have been removed from the enclosure, re-insert boards with the system powered and continue with the enclosure upgrade instructions.
16. To upgrade the enclosure/boards, follow the directions on page 264.

Optional (recommended) – Affix the provided sticker to label the product as part of the Enova DGX 100 Series. Enova DGX Switchers upgraded to the 100 Series are supported by the Hardware Reference Manual – Enova DGX 100 Series Digital Media Switchers and other documentation marked for the 100 Series.

Audio Switching Boards (ASB and ASB-DAN) - Rules for System Setup

- Audio Switching Boards must be installed as pairs. They will not work unless both an input and an output board are installed in the same enclosure (if the enclosure is an Enova DGX 6400, two input and two output boards are required).
- When adding ASB Boards to an enclosure that does not already have them installed, be sure to use the correct board set designated for the enclosure size:
 - FG1061-716 – Audio Switching Board Set for the Enova DGX 800/1600 (contains 2 boards)
 - FG1061-732 – Audio Switching Board Set for the Enova DGX 3200 (contains 2 boards)
 - FG1061-764 – Audio Switching Board Set for the Enova DGX 6400 (contains 4 boards)
 - FG1061-832 – Dante Audio Switching Board Set for the Enova DGX 800/1600/3200 (contains 2 boards)
 - FG1061-864 – Dante Audio Switching Board Set for the Enova DGX 6400 (contains 4 boards)
- Enova DGX 6400 Audio Switching Boards must be installed in specific expansion board slots:
 - Audio Switching Input Boards (2) in the left and right slots immediately above standard input board slots
 - Audio Switching Output Boards (2) in the left and right slots immediately below standard output board slots

- Audio Switching Boards, Dante Audio Switching Boards, and Audio Insert/Extract Boards are not compatible. Do not install mixed types of expansion boards in the same enclosure. If two types of boards are present, the audio subsystem is disabled.

For information on routing of audio signals (including the down-mixed audio input) using these boards, see page 128.

NOTE: *Enova DGX 100 Series switchers contain an audio-only virtual matrix (VM2). If ASB Boards are in the enclosure, you can route audio switches on this matrix. If no audio boards are installed, route and disconnect commands are queued until audio boards are present, while all other commands are NACK'd.*

Upgrading the Enclosure (Including Boards)

The following procedure explains how to send a firmware (*.KIT) file to the enclosure to enable boards to work with the new CPU.

NOTE: *EDIDs are not automatically updated when firmware is upgraded. To update input board EDIDs after an enclosure firmware upgrade, you must use the `reset factory DGX_SHELL` command (see page 280).*

1. Download and unzip the "Enova DGX 100 Series Enclosure Firmware." .zip file:
 - a. Navigate to the Enova DGX 100 Series product page that matches your system at www.amx.com.
 - b. Locate the Firmware Files section on the right side of the page and select the .zip file for download.
 - c. Unzip and open the downloaded file folder.
2. Open the latest version of NetLinx Studio and navigate to the OnLine Tree.
3. From the Settings tab, select Workspace Communication Settings, and click on Default Settings.
4. In the Network tab, click New, enter the system's new IP address (available through the control panel menu), click OK. Select the system and click OK.
5. Click OK to close the Workspace Communications Settings dialog box.
6. In the OnLine Tree, right-click and select Refresh System OnLine Tree.
7. **Optional** (recommended) – Launch the System Configuration interface on a PC or device to monitor the upgrade.
 - a. On the enclosure's control panel, navigate to Function/Setup Options/Master Info/IP Address.
 - b. Open a web browser on a PC or device on the same network as the Enova DGX and enter the system's IP address in the browser bar.
 - c. Navigate to System/Devices and click on Switcher Update Status. Continue monitoring through the rest of the process.
8. In the OnLine Tree, right-click on the 5002 device and select Firmware Transfer.
9. Click the Browse (...) button to navigate to the target directory (FIG. 150):

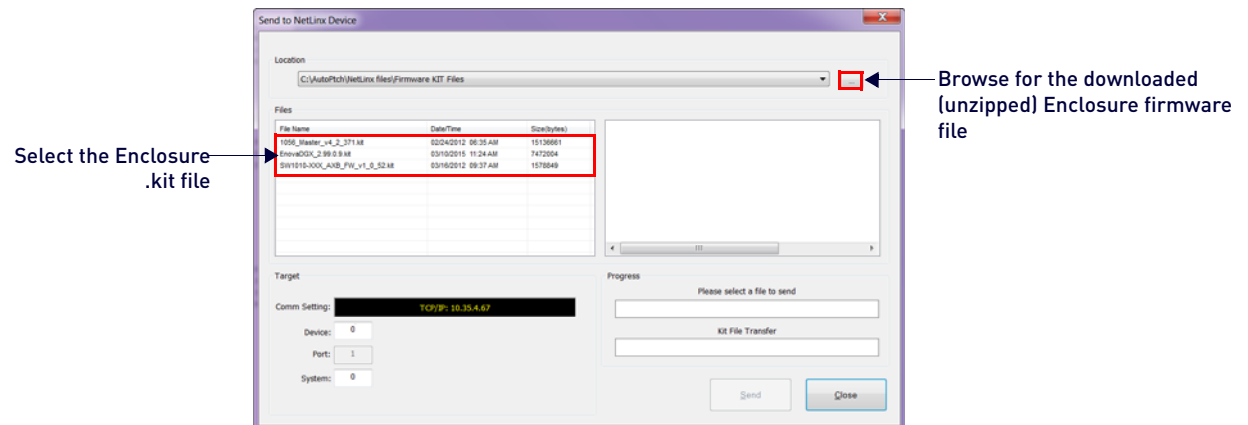

FIG. 150 NetLinx Studio - Send to NetLinx Device dialog

10. Select the file for the Enova DGX from the Files list. Click Send.
 - During the switcher's upgrade process:
 - The Enova DGX Switcher stays offline (does not display in the OnLine Tree).
 - The control panel and System Configuration interface (System/Devices/Switcher Update Status) display upgrade status messages.
 - Power cycles will not abort the upgrade; let it run until completion.
 - Once the upgrade is complete:
 - The LEDs return to normal.
 - The Enova DGX Switcher comes back on line (displays in the OnLine Tree).
 - The System Configuration interface upgrade status (System/Devices/Switcher Upgrade Status) reports that the system is rebooting.

NOTE: *If any of the boards do not upgrade, the 5002 device can take 15-30 minutes to come online (depending on enclosure).*

11. If the enclosure previously held AIE boards, or had unused expansion slots, and you have added ASB expansion boards to the enclosure with this upgrade, follow the instructions for enabling ASB default switched/embedded settings on the following page.

Adding Audio Switching Boards (ASB or ASB-DAN) to an Upgraded Enclosure

If adding ASB boards to an enclosure that previously held Audio Insert/Extract (AIE) boards, or an enclosure that held no expansion boards, you must enable the audio sub-system's default ASB switched/embedded settings. Instructions for enabling default settings require using the DGX_SHELL interface.

To enable default settings on the audio sub-system:

1. Launch the DGX_SHELL prompt (see page 273).
2. Enable level 2 (super user) commands:
 - a. From the DGX_SHELL prompt, type `su enova 12amx34` followed by <enter> (FIG. 151):

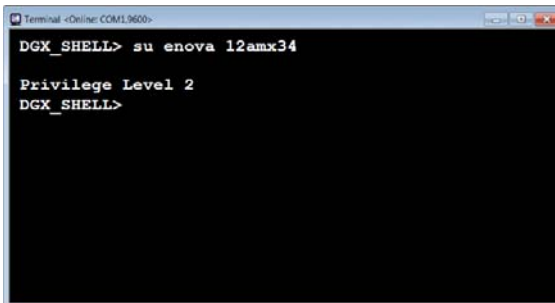

```

Terminal «Online: COM1,9600»
DGX_SHELL> su enova 12amx34
Privilege Level 2
DGX_SHELL>
  
```

FIG. 151 DGX_SHELL - su enova 12amx34

3. Toggle the audio routing to "switched" (ASB default) on all output boards:
 - a. Type `passthru OFF BCPU` followed by <enter>.
4. Check the Switch Mode setting on the output boards (FIG. 152): Type `show aie` followed by <enter> and confirm that the populated output boards all show a Switch Mode setting of `01` (switched) and not `00` (extracted) or `02` (embedded):

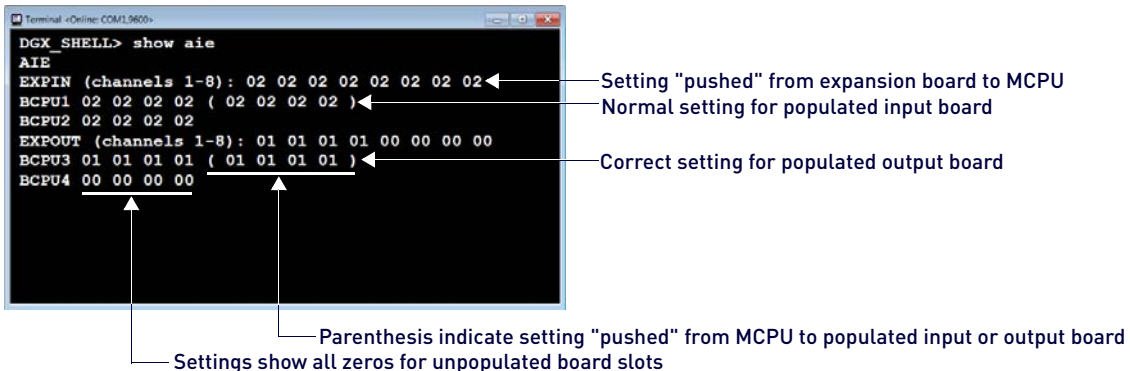

```

Terminal «Online: COM1,9600»
DGX_SHELL> show aie
AIE
EXPIN (channels 1-8): 02 02 02 02 02 02 02 02
BCPU1 02 02 02 02 ( 02 02 02 02 )
BCPU2 02 02 02 02
EXPOUT (channels 1-8): 01 01 01 01 00 00 00 00
BCPU3 01 01 01 01 ( 01 01 01 01 )
BCPU4 00 00 00 00
  
```

FIG. 152 DGX_SHELL - show aie

5. With ASB default settings applied, continue installation or operation of the Enova DGX 100 Series switcher

Upgrading DXLink Transmitter/Receiver Endpoints

Upgrading DXLink Twisted Pair and DXLink Fiber endpoints requires downloading the latest firmware files and using NetLink Studio to transfer the files to the target endpoint. In order to be able to locate endpoints in NetLink Studio, either change the IP Address of the upgraded Enova DGX to the same IP Address held by the pre-upgrade Enova DGX (maintains previous configuration settings; forgoes Auto-setup) or use the endpoint ID Pushbutton to return the endpoint to default settings (in preparation for Auto-setup).

CAUTION: *Upgrading the firmware is a serious action in that if the upgrade fails, it can leave the device completely nonoperational. If the upgrade fails or power is lost during upgrade, reboot the Transmitter or Receiver and attempt to upgrade the firmware again, as the module is in an unknown state and cannot be guaranteed to be operational.*

NOTE: *Some older DXLink Twisted Pair Receivers are not compatible with DXLink Twisted Pair 4K Output Boards. Instructions for identifying incompatible Receivers are available on page 123.*

1. Download and unzip the "Enova DGX 100 Series DXLink [Twisted Pair or Fiber] Firmware" .zip file:
 - a. Navigate to the endpoint's product page at www.amx.com.
 - b. Locate the Firmware Files section on the right side of the page and select the .zip file for download.
 - c. Unzip and open the downloaded file folder.
2. Launch NetLink Studio and navigate to the OnLine Tree.

- In the OnLine Tree tab, right-click in the Workspace Bar and select Refresh System OnLine Tree. Verify that the DXLink unit is listed in the OnLine Tree.
- Select Tools/Firmware Transfers/Send to NetLink Device to open the Send to NetLink Device dialog (FIG. 153):

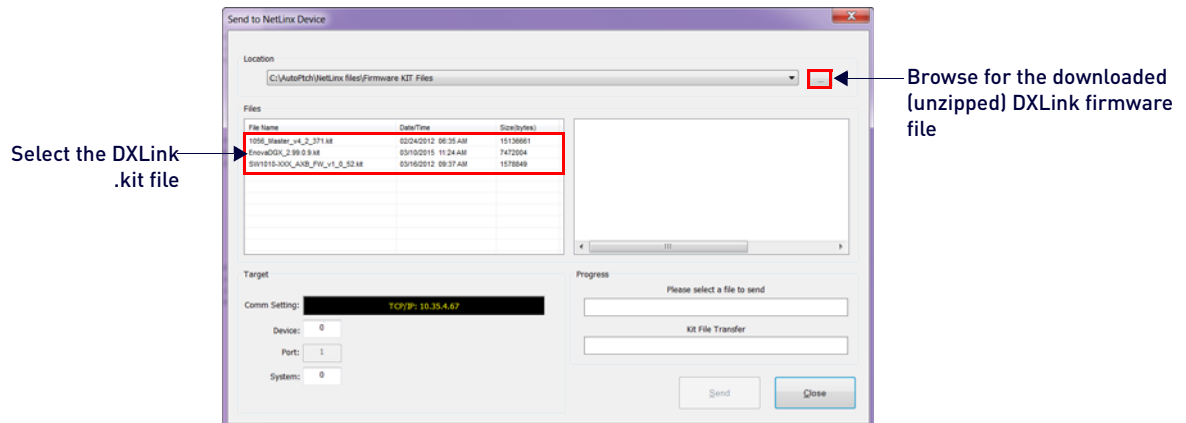

FIG. 153 NetLinX Studio - Send to NetLink Device dialog

- Click the Browse button (...) and navigate to the downloaded file.
- Select the file for the DXLink unit (.kit file) and click Send.
- Click Close once the download process is complete. Reboot the DXLink unit.
- In the OnLine Tree, right-click on the switcher and select Refresh System (this establishes a new connection and refreshes the device list and their firmware versions in your system).

NOTE: Reset factory settings on DXLink Fiber Transmitters (enables access to most recent AMX-provided EDIDs).

To reset factory settings and enable the most recent EDIDs on a DXLink Fiber TX via Pushbutton ID:

CAUTION: Resetting factory settings does not reset the firmware version, but does remove any settings previously applied to the transmitter, applies EDID formats provided by the firmware, and enables auto-setup mode.

- Unplug the power connector from the rear of the Transmitter.
- Press and hold the ID Pushbutton on the of the DXLink Fiber TX while plugging in the power connector.
- When the NetLinX LEDs begin to flash in unison, start counting flashes (at the rate of once per second).
- As soon as the blink rate increases (after 10 flashes at that rate, the LEDs begin to blink at a faster rate), release the ID Pushbutton.
- The Transmitter automatically reboots to complete the process.

NOTE: DXLink Transmitter factory settings can also be reset via Telnet.

Downgrade Sequence Overview

The sequence provided below is the only approved sequence for downgrading an Enova DGX 100 Series Digital Media Switcher.

IMPORTANT: If an Enova DGX is upgraded from 8/16/32/64 to 100 Series, downgraded back to 8/16/32/64, and then re-upgraded to 100 Series, you must check the firmware versions for all boards in the enclosure (monitor upgrade via the System Configuration interface on the System/Devices/Switcher Update Status page). If some or all of the firmware versions have not been upgraded to 100 Series firmware versions as expected (see Status page during upgrade), upgrade the enclosure a second time.

NOTE: Solecis Digital Switchers do not need to be downgraded to work with the Enova DGX 8/16/32/64. Always use the latest available firmware with Solecis units.

- Downgrade any DXLink Twisted Pair or DXLink Fiber endpoints (see below).
- Replace the current (100 Series) CPU Board with an Enova DGX 8/16/32/64 CPU (see the following page).
- Downgrade the enclosure (see below).
- Downgrade the front control panel (see below).

Downgrading DXLink Endpoint Firmware

Download the latest version of DXLink firmware that is compatible with an Enova DGX 8/16/32/64 Digital Media Switcher and use the "Upgrading DXLink Transmitter/Receiver endpoints" instructions provided on page 265 to apply the downloaded firmware version. Enova DGX 8/16/32/64 compatible firmware is available on your DXLink product's page at www.amx.com.

DXLink Firmware Compatibility		
	Enova DGX 8/16/32/64	Enova DGX 100 Series
DXLink Twisted Pair Transmitters	1.6.67	1.8.28
DXLink Twisted Pair Receivers	1.9.69	1.13.34
DXLink Twisted Pair 4K Receivers	N/A	2.2.23
DXLink Fiber Transmitters	1.2.12	1.4.12
DXLink Fiber Receivers	1.2.1	1.4.17

Downgrading Enova DGX 100 Series Enclosures

Download the Enova DGX 8/16/32/64 enclosure firmware (from the corresponding product page at www.amx.com) and use the "Upgrading the Enclosure" instructions provided on page 264 to apply the downloaded firmware version.

Enova DGX Enclosure Firmware	
Firmware Version	Compatible with
2.2.11	Enova DGX 8/16/32/64 enclosures
3.2.19	Enova DGX 100 Series enclosures

Downgrading the Front Control Panel

Download the Enova DGX 8/16/32/64 control panel firmware (from the corresponding product page at www.amx.com) and use the "Upgrading the Control Panel" instructions on page 260 to apply the downloaded firmware version.

Enova DGX Control Panel Firmware	
Firmware Version	Compatible with
2.0.3	Enova DGX 8/16/32/64 enclosures
2.2.0	Enova DGX 100 Series enclosures

Removing 100 Series CPU Board and Installing Enova DGX 8/16/32/64 CPU Board

CAUTION: Do not remove CPU board until you are ready to install the replacement, unless directed to do so by technical support.

Important Information for CPU Downgrade from 100 Series to 8/16/32/64

- Do not transfer SD cards from the Enova DGX 100 Series CPU into the Enova DGX 8/16/32/64 CPU. SD cards from Enova DGX 100 Series CPUs and Enova DGX 8/16/32/64 CPUs have different functions.
- Audio Switching Boards are not supported within the Enova DGX 8/16/32/64; therefore, these boards must be removed prior to using the new CPU.
- Endpoint devices bound to the replaced integrated Master (DGX 100 Series CPU) via TCP/UDP connection scheme are not detectable by the new integrated Master (DGX 8/16/32/64 CPU) until the new Master is configured for the IP address used by the previous Master. (NDP devices appear in NetLinx Studio's OnLine Tree as unbound devices.)

Items Required

- Enova DGX 8/16/32/54 replacement CPU board
- Phillips #1 screwdriver
- ESD wristband and cord with an alligator clip



FIG. 154 Enova DGX 8/16/32/64 CPU board (top view)

ESD WARNING: To avoid ESD (Electrostatic Discharge) damage to sensitive components, make sure you are properly grounded before touching any internal Enova DGX materials. Use an ESD wristband and cord with an alligator clip attached to a good ground source.

To remove and replace an Enova DGX CPU board assembly:

NOTE: If Audio Switching Boards are in the enclosure, remove them before beginning the following instructions.

1. Turn off AC power to the enclosure. Make sure none of the power supply LEDs are illuminated.
2. Disconnect all cables connected to the CPU and unplug the AxLink connector.
3. Remove the screws from CPU faceplate per the locations indicated in FIG. 155 (four screws in Enova DGX 6400, three screws in Enova DGX 800/1600/3200).



FIG. 155 Remove screws that hold faceplate

4. Remove the CPU faceplate and set aside.
5. Use the removal tab indicated in FIG. 156 to pull the CPU board assembly straight out of the enclosure.

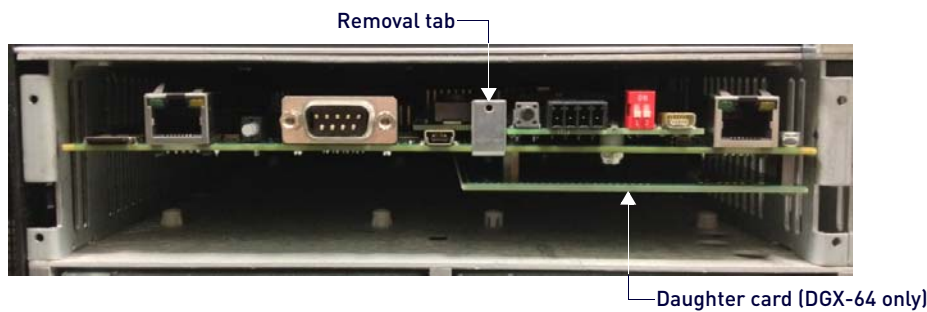

FIG. 156 Use removal tab to pull CPU straight out

6. Place the old (100 Series) CPU board in an ESD approved static shield bag and set aside.
7. Slowly slide the replacement CPU board into the empty slot, being careful to align the edges in the board guides along the insides of the slot (FIG. 157).

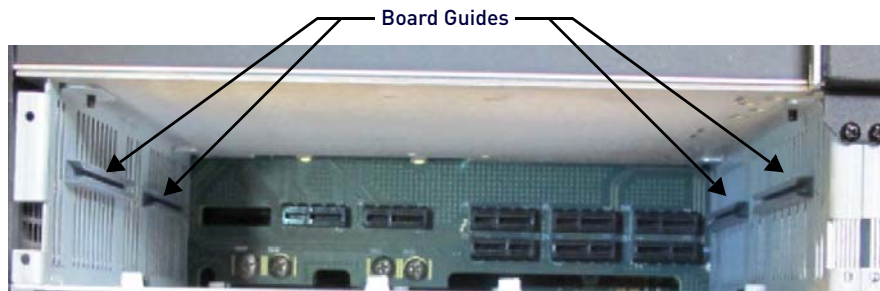

FIG. 157 Use removal tab to pull CPU straight out

8. Push on the CPU removal tab (FIG. 156) firmly enough for the board to make a good electrical connection (avoid pushing on the connectors). When the CPU board is fully inserted, its faceplate should sit flush with the back metal.
9. Set 100 Series CPU faceplate aside and reattach the Enova DGX 8/16/32/64 faceplate provided with the CPU.
10. Apply power to the enclosure.
11. Check the CPU's System Status LED for indications of normal display (see table below).



FIG. 158 System Status LED indicator (Enova DGX 64 shown)

LED Indicator	Indicates	Normal Display	Cautionary Display
System Status LED	System status	Constant green during power up, then blinking green at 1/2 second on/off intervals	<ul style="list-style-type: none"> Blinking red/green: an exception has been logged in IOS (validation failure) Blinking red: dropped into IOS mode

NOTE: A system is in IOS mode when an unexpected, temporary, critical error is trapped and logged and control is passed to the host software (IOS) which prevents the normal appcode from running until the error is manually cleared. Please report all such errors to technical support (see page 80).

12. Re-attach any cables that were removed in Step 2.
13. Execute a test switch to make sure the system is working correctly.

NOTE: If you are not familiar with operating this type of system, see the Enova DGX 8/16/32/64 Digital Media Switchers Hardware Reference Manual at www.amx.com for control information.

Troubleshooting

First

Check all cable connections, check the System Status LED, and execute a test switch.

If the System Status LED is still not illuminated or the test switch does not work

Repeat the installation procedure, checking the internal SD card to be sure it is securely in place and re-seating the CPU board to make sure that connection is established.

If the System Status LED still does not display normal indications

Contact technical support.

Appendix F - DGX Configuration Software

Overview

IMPORTANT: Because signals routed through Input and Output Boards in an Enova DGX Switcher normally produce a quality image, you *will not* need the information in this appendix unless the installation has special scaling, EDID, or HDCP requirements. Most of the functionality provided by DGX Configuration Software is available through the primary user interface, the System Configuration interface (see page 127).

DGX Configuration Software provides HDMI, DVI, DXLink Twisted Pair, and DXLink Fiber Boards functionality for the following:

- Scaler Mode – Use to set the Scaler mode to Auto, Bypass, or Manual (override). Also used to set the Aspect Ratio. (See page 272.)
- Scaler Override – Use to set custom resolutions. (See page 273.)
- EDID Programmer – Use to re-program the EDID EEPROM chips on the input boards, allowing for custom configuration of the EDID data that is stored on the boards. (See page 276.)
- HDCP Settings – Use to enable or disable HDCP Support for specific inputs. (See page 281.)
- Terminal – Provides a basic terminal emulation interface for entering BCS commands, etc. (See page 281.)

The program is available at www.amx.com and includes a standard Help file with detailed information.

PC System Requirements for DGX Configuration Software v1.0.6

- Windows 7 or later
- Minimum Hardware: 166 MHz, 128 MB RAM, 35 MB of free disk space, 800x600 display, serial port, video card with dual outputs
- Recommended Hardware: 2.0 GHz, 512 MB RAM, 1024x768 display

NOTE: The installation process requires 35 MB of disk space for the DGX Configuration Software installer. Once installed, the program requires 10 MB of disk space.

- Administrator rights may be required to install DGX Configuration Software.

NOTE: For installations where DGX Configuration Software is required – The Enova DGX 100 Series default command environment is DGX_SHELL and DGX Configuration Software is designed for optimal use with BCS (Basic Control Structure) Protocol, therefore we suggest changing the default command environment to BCS. From the DGX_SHELL> command prompt, send the command `set shell_start_cmdstr_COM1=bc` and reboot the system. The next time the command environment is accessed, it starts in BCS.

Software Installation on PC and Enova DGX Connection

To install DGX Configuration Software:

1. From the switcher's product page at www.amx.com (under Application Files in the right-hand column), double-click **DGX Configuration Software**.
2. Accept the AMX License Agreement, then select **Open** to download the file.
Optional – Select `DGX_Config_SoftwareReadMe_vX_X` to read about the software before installation.
3. Click the application file (which is zipped).
4. In the *Compressed (zipped) Folders* dialog, click **Extract All**.
5. Select a destination for the files.
6. When the download is complete, click the application file and follow the directions in the installation wizard.

NOTE: If you plan to use the terminal emulation function of the software, a serial connection is required.

DGX Configuration Software Setup

1. Attach a null modem serial cable matching the RS-232 pinout (FIG. 159) to the Control port on the enclosure's CPU and attach the free-running end of the cable to a PC.

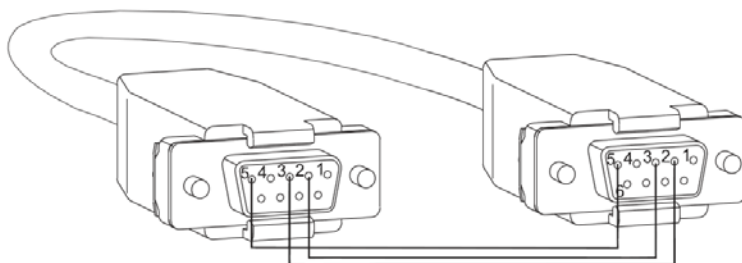

FIG. 159 RS-232 pinout for null modem serial cable

2. Apply power to the enclosure.

3. On the PC, open DGX Configuration Software.
4. From the Communication menu:
 - a. Select **Serial Port**.
 - b. Select **Change Settings**, change the Baud Rate to **115200**, and click **OK**.

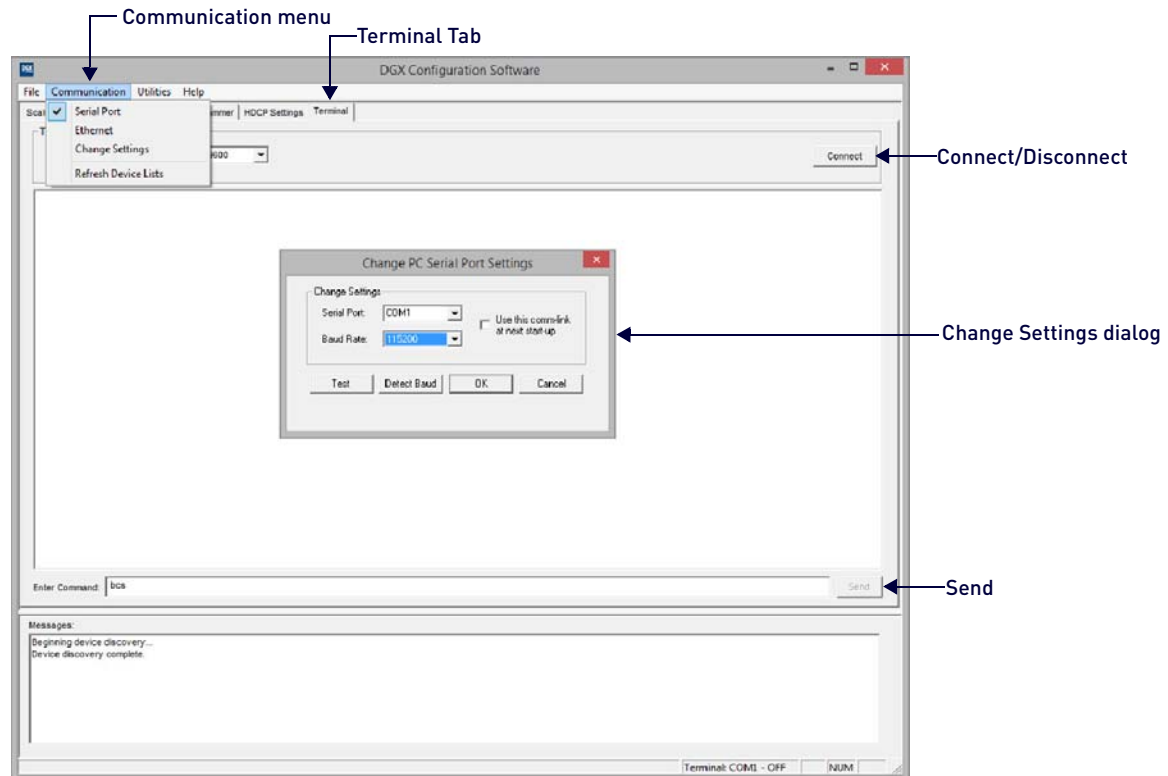

FIG. 160 DGX Configuration Software - Serial Port Settings

5. From the Terminal tab:
 - a. Change the Baud Rate to **115200** and click **Connect**.
 - b. In the Command field, enter: CTRL+C, then type **bcs** and click the Send button.
 - c. Click **Disconnect**.
6. From the Communication menu, select Refresh Device.

General Notes for Working with DGX Configuration Software

- DGX Configuration Software only displays inputs and/or outputs that can be modified.
- File menu – Select Open File to load a file to the program (the file type available depends on the selected view). Select Save to File to save a file containing the currently displayed settings in the currently selected view.
- Communication menu – Use to change the communication settings for the DB-9 serial and Ethernet ports. This menu also includes the option to "Refresh Device Lists," which affects *all* device lists in the program.
- Utilities menu – If the program cannot read and write the EDID data from the destination devices, the system may not support all of the DGX Configuration Software functionality.
- Help menu – Access the Help file for the program, open a link for the Web Update option (to download updates for the program), and view current version information.
- Messages in the bottom pane of the DGX Configuration Software dialog box report status of operations. Messages can be copied for technical support purposes.

NOTE: Right-click on a message to access a short-cut menu with options to Copy Selected, Copy All, or Clear. When copying multiple messages: either select consecutive items by holding down the Shift key and clicking the first and last item or select nonconsecutive items by holding down the Control key and clicking on each item.

- DXLink Fiber hardware – Only Duplex hardware in Bidirectional Mode with both fibers connected will allow DGX Configuration Software to read EDID data from a destination device.

Scaler Mode View

The HDMI Output Board supports SmartScale® Technology to ensure appropriate output resolution regardless of the type of incoming video. For systems with special requirements, a Bypass option and a Manual (override) option for setting custom resolutions are also available.

NOTE: *SmartScale automatically responds to the preferred EDID information and delivers a custom scaled image based not only on the preferred resolution but also on the additional information associated with that resolution (e.g., h/v pixel count, detailed timing, and color space). SmartScale eliminates the incompatibilities between sources and displays operating at different resolutions by accepting the highest resolution of every source device ensuring every display operates at its preferred resolution.*

In the Scaler Mode view, the default settings for the Current and Default scaler modes are both "Auto" (SmartScale) and the default setting for Aspect Ratio is "Maintain Aspect Ratio."

NOTE: *If the SmartScale functionality on the boards does not result in a good image, the reason may be because of the display device's handling of the image, e.g., cutting the display short or adding too much space around the display. These types of concerns need to be addressed through the display device's control menu or by consulting the display device's customer support department.*

Scaler Modes

Auto Mode

Auto Mode is the factory default setting and provides SmartScale Technology, which configures the output(s) to automatically scale the video to the best resolution (up to 1920x1200) and the video settings for that display without manual setup. If the image is satisfactory, no further action is required.

Bypass Mode

Bypass mode allows the video signal to pass un-scaled through the system.

If an output connector fails to read the EDID from its attached destination device on power up (i.e., no resolution data is available from the device), the output connector reverts to the Bypass mode until the video cable is unplugged and then plugged in, at which time it will attempt to read the EDID again.

NOTE: *When Bypass mode is selected, both interlaced and replicated format can be passed.*

Manual (Override) Mode

When you select Manual in the Scaler Mode view, the program sets up the video scaler with the factory default values (1280x1024 @ 60 Hz) for the selected outputs.

The Manual mode allows you to manually configure a specific or a custom scaled output resolution to send to the display monitor(s). In this mode, the system ignores the EDID data being received from a display up to 1920x1200. When you select and set the Manual (override) scaler mode, select the Scaler Override tab to configure the resolution (see page 273).

Changing the Scaler Mode Settings

1. Select the **Scaler Mode** tab (FIG. 161):

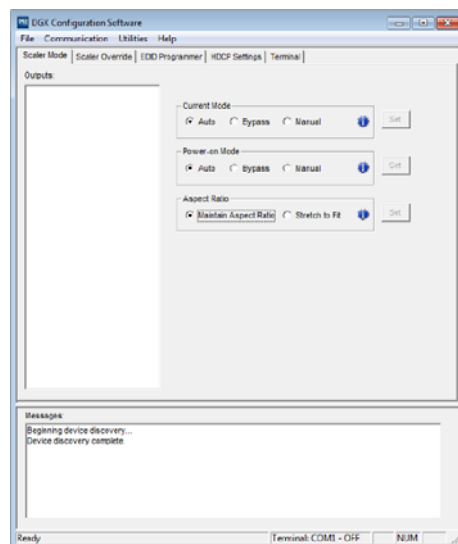

FIG. 161 Scaler Mode tab

2. Select the desired output(s). (When selecting multiple outputs: either select consecutive outputs by holding down the Shift key and clicking the first and last output or select nonconsecutive outputs by holding down the Control key and clicking on each output.)
3. Click any or all of the following:

- The desired Current and Default scaler modes (for explanations of the three modes, see the previous page)
 - The Aspect Ratio of the display (for an explanation of the aspect ratio options, see below)
4. Click the appropriate **Set** button(s) to persist the setting(s).

Maintain Aspect Ratio and Stretch to Fit

Select one of the two aspect ratio options for the selected outputs: *Maintain Aspect Ratio* (default) and *Stretch to Fit*.

1. Select the desired output(s).
2. Select one of the Aspect Ratio options:
 - **Maintain Aspect Ratio** – This option maintains the incoming video's aspect ratio. The image is scaled until the video fills either horizontally or vertically first. If the vertical direction is filled first, then the video will have pillar box, black bars on the sides of the display. If the horizontal direction is filled first, then the video will have letter box, black bars on the top and bottom of the display.
 - **Stretch to Fit** – This option scales the video to fill the display in both the horizontal and vertical directions. Black bars do not show when Stretch to Fit is selected.
3. Click the **Set** button to the right. The selected aspect ratio will now persist to the Auto and Manual (override) modes. The Bypass mode remains unaffected.

Scaler Override View

From the Scaler Override view (Manual mode), an output can be selected under "EDID Source." Click Refresh EDID to determine the attached destination device's resolution and then apply it to one or more outputs which have been selected in the device tree on the left.

In some special installation cases, you will need to use the settings in the Scaler Override view to override the automatic scaling and set (configure) a specific or a custom resolution for the display monitor. When an Enova DGX Switcher is connected to a PC running DGX Configuration Software, the program displays the resolutions supported by the selected destination monitor (or other destination device) based on the set of supported resolutions in the monitor's EDID. Settings can then be selected and applied to the output.

When you select Manual in the Scaler Mode view, the selected connector sets up the video scaler with factory default values (1280x1024 @ 60 Hz). EDID preferred resolution settings are used if available, unless scaler setup settings were previously uploaded.

IMPORTANT: *If a device with an EDID (e.g., a video processor) is installed between the output and destination monitor, see page 280.*

NOTE: *When the following timings are in the EDID data, the Scaler Override view will not display them: 720x400 @ 70 Hz, 720x400 @ 88 Hz, 640x480 @ 67 Hz, 832x624 @ 75 Hz, and 1152x870 @ 75 Hz. These timings can be entered in the program as custom resolutions.*

Get Current Timing, Apply, and Save Buttons

- **Get Current Timing** – Click to retrieve timing currently stored on the selected output. This allows you to either apply those settings to other outputs that are connected to similar destination devices or to save the current timing as a backup before making any modifications.
- **Apply** – Click to see how well settings work. Sends currently displayed settings to the destination. Selecting Apply does not store or persist settings. If Apply was just selected and you close the program without saving any changes in the settings, the program asks whether or not to save the applied settings.
- **Save** – Click to preserve currently displayed settings on the output connector. Sends displayed settings to an output to store and persist them in the output's memory. This button also persists the Scaling Override (Manual) option on the output.

File Menu Options: Open File and Save to File

- **Open File** – Select to load the settings from a file to the program.
- **Save to File** – Select to save the currently displayed settings to a file. The file type available depends on the selected view.

TIP: *When selecting outputs: select multiple, consecutive outputs by holding down the Shift key and clicking the first and last output or select multiple, nonconsecutive outputs by holding down the Control key and clicking on each output.*

Retrieving EDID timings From a Destination Device

NOTE: *DXLink Fiber hardware in Unidirectional or Data Link-lost Mode – EDID timings are not accessible as there is no return path available to receive the information.*

1. From the Scaler Mode tab, select and set **Manual** (override) as the mode.
2. Select the **Scaler Override** tab.
3. Under **EDID Source**, select the Enclosure and select the **Output** number connected to the desired destination from the drop-down lists. The system is queried for all compatible devices found with the default (or last saved) communication link setting (FIG. 162):

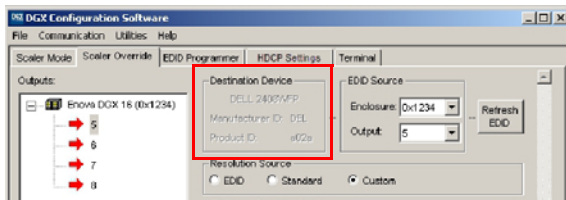

FIG. 162 Destination device description, Manufacturer ID, and Product ID

4. Click **Refresh EDID**. A short description of the destination device displays to the left of the drop-down list along with the Manufacturer ID and Product ID (e.g., DELL 2408WFP; DEL; a02a). The Scaler Override view is populated with the EDID timings from the detected device.
5. Complete one of the following options (each option includes a step for saving the EDID). Note that options A, B, and C assume that the previous instructions for reading an EDID have been completed and the DGX Configuration Software is open to the Scaler Override view:
 - a. To set the EDID timings that were read from the device that was detected in the previous step, see the next page.
 - b. To set a standard preset, which applies standard timing, see page 275.
 - c. To set a custom resolution with the option of applying advanced detailed timing settings, see page 276.

NOTE: When a number of outputs are connected to destination devices of the same type, the *Get Current Timing* button can be used to retrieve the settings.

(A) Setting an EDID Timing That Was Read From The Detected Device

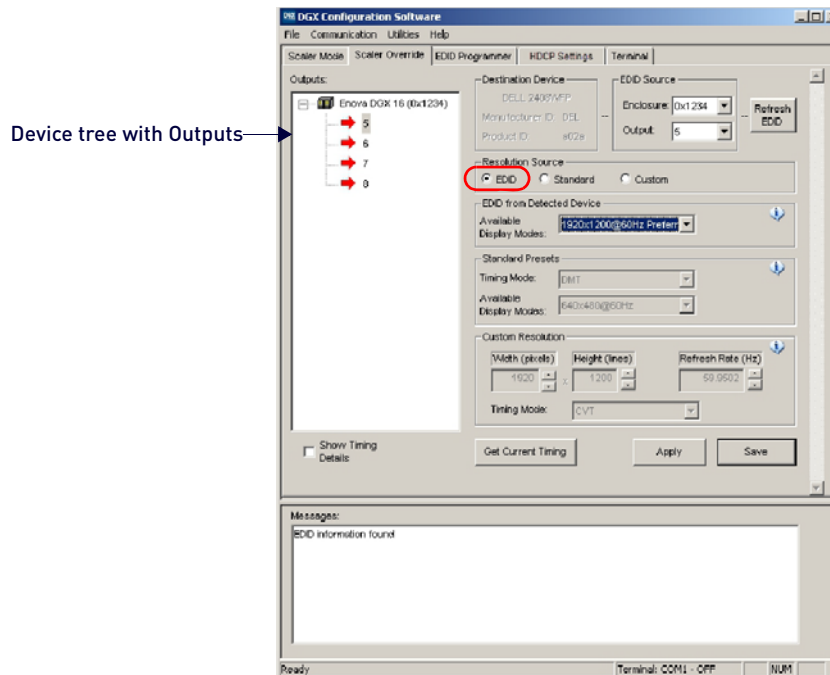
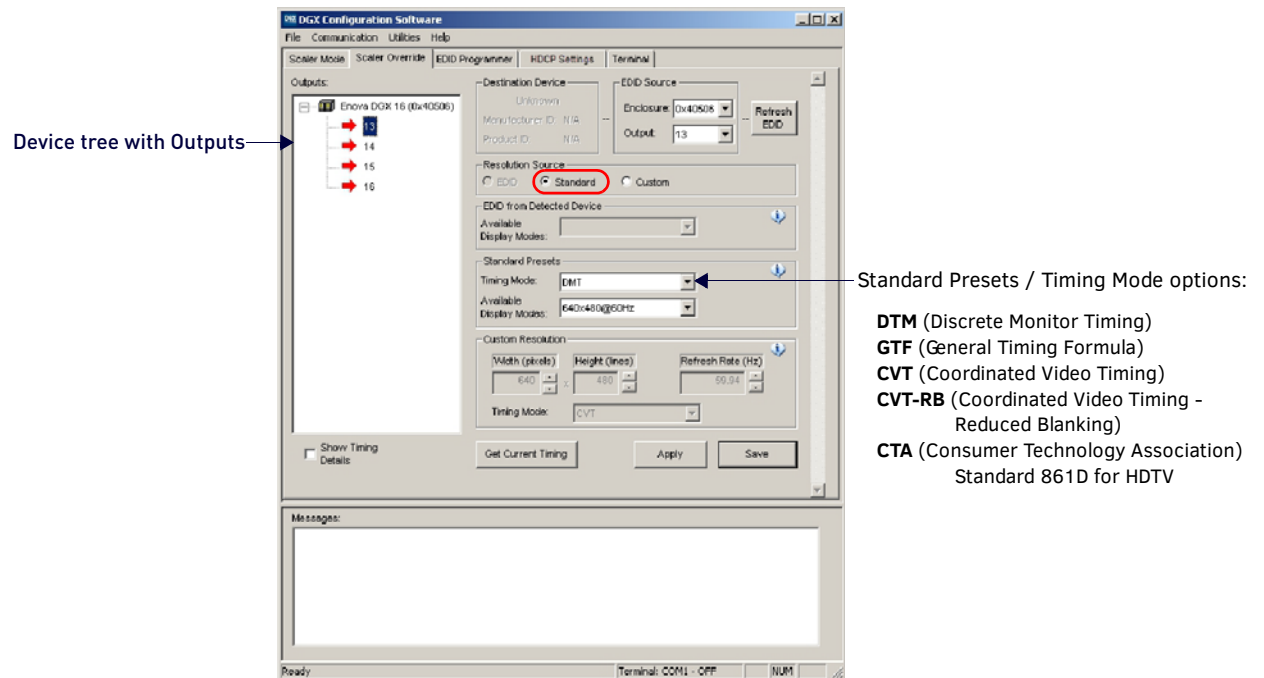

FIG. 163 Scaler Override view with EDID selected

1. Under Resolution Source, click **EDID**.
2. Under EDID from Detected Device – From the Available Display Modes drop-down list, select the desired resolution (only resolutions supported by the detected device are included).
3. In the device tree on the left, select an output to send the resolution information to that output. Multiple outputs may be selected.
4. Click **Apply** to transmit the selected information to the output(s). This action is temporary until settings are stored on the connector(s) in Step 6. Otherwise, the settings last only until power is cycled. The display re-syncs with the input(s).
5. Verify that the display is satisfactory before proceeding.
6. Click **Save** to store the currently displayed settings to the connector(s) and persist them in memory. If the settings have been changed since clicking Apply, the newest settings will be saved.

(B) Setting a Standard EDID Preset**FIG. 164** Scaler Override view with Standard Presets selected

1. Under Resolution Source, click Standard.
2. Under Standard Presets, select the desired timing mode from the Timing Mode drop-down list.
3. Under Standard Presets, select the resolution from the Available Display Modes drop-down list.
4. In the device tree on the left, select an output to send the resolution information to that output. Multiple outputs may be selected.
5. Click Apply to transmit the selected information to the output(s). This action is temporary until settings are stored on the connector(s) in Step 7. Otherwise, the settings last only until power is cycled. The display re-syncs with the output(s).
6. Verify that the display is satisfactory before proceeding.
7. Click Save to store the currently displayed settings to the connector and persist them in memory. If the settings have been changed since clicking Apply, the newest settings will be saved.

(C) Setting a Custom Resolution With Optional Advanced Detailed Timing Settings

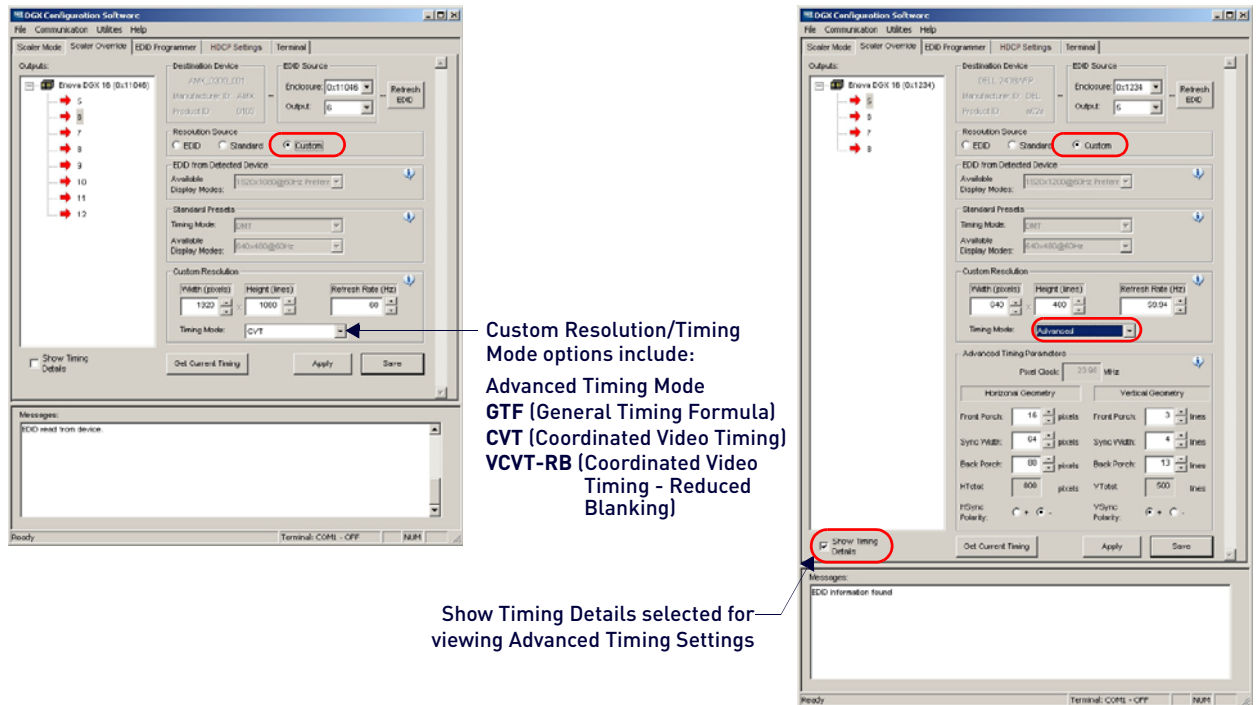

FIG. 165 Scaler Override view with a Custom Resolution selected (left); Advanced Timing Mode selected (right)

- Under Resolution Source, click Custom.
- Under Custom Resolution, enter the width, height, and refresh rate.
- Under Custom Resolution, select the timing mode from the Timing Mode drop-down list. If Advanced is selected from the list, the Advanced Timing Mode section opens. Select Show Timing Details if desired.) Complete all remaining steps.
- or -
If another timing mode is selected from the list, go to Step 5.
- Advanced only – Under Horizontal Geometry, enter the values in number of pixels. Under Vertical Geometry, enter the values in number of lines. Select HSync (+ or -) and VSync (+ or -) Polarity.
- In the device tree on the left, select an output to send the resolution information to that output. Multiple outputs may be selected.
- Click Apply to transmit the selected information to the output(s). This action is temporary until settings are stored on the connector(s) in Step 8. Otherwise, the settings last only until power is cycled. The display re-syncs with the output(s).
- Verify that the display is satisfactory before proceeding.
- Click Save to store the currently displayed settings to the connector(s) and persist them in memory. If the settings have been changed since clicking Apply, the newest settings will be saved.

NOTE: Down scaling to 800x600 – When using the program to scale from 1280x1024 down to 800x600, occasionally the video changes to a solid color screen and needs to be reset to restore the image. Auto Scaling is recommended when possible.

EDID Programmer View

From the EDID Programmer view, EDID EEPROM chips on each of the DGX HDMI and DGX DVI Input Board connectors can be re-programmed independently if necessary.

EDID Overview

EDID (Extended Display Identification Data) is a data structure established by the Video Electronics Standards Association (VESA) to enable plug-and-play support by enabling easy configuration of a computer's graphics subsystem based on the capabilities of the attached display device.

EDID information includes items such as the following:

- Manufacturer's name
- Product type
- Supported video resolutions and refresh rates
- Color space and filter
- Detailed timings

When a computer is directly connected to a display device, it can use the display device's EDID information to determine an initial compatible video signal to send. With the computer's display controls, the user can modify this selection to another compatible signal based on the provided EDID information.

With DVI and HDMI signals (both require EDID on the display devices), using EDID information has extended beyond computers to other source devices, such as DVD players. As long as the source device sends a compatible signal, the plug-and-play feature will work.

Digital Media Switchers and EDID

Digital Media Switchers, such as the Enova DGX, provide the ability to route one source signal to many potentially different types of display devices. In almost all cases through the use of compatible DXLink Receivers (featuring SmartScale Technology), incompatibilities between source device resolutions and displays are automatically resolved as each receiver independently scales each source device's video to the native resolution.

In cases where local DVI or HDMI outputs are used and a resolution incompatibility exists (or if a source device needs a specific resolution), the DGX DVI and DGX HDMI Input Boards have the ability to update the EDID emulation file (by updating each input's EEPROM chip) which comes pre-loaded with an EDID set.

This EDID set consists of some of the most common EDID settings in use today, including VESA and HDTV settings encompassing resolutions for Standard Timings and resolutions for Established Timings (for HDMI timing details, see page 93; for DVI, see page 104). In many cases, the switcher can be used straight out of the box with no adjustments (see "Determining the Need for EDID Re-programming" on page 277).

The DGX Configuration Software with EDID programming functionality has been provided for cases where additional in-field programming of a board's input connectors EDID chips is needed. The EDID Programmer view can be used for the following:

- Reading and saving EDID data in hexadecimal from an output receiving the information from its attached destination device
- Writing EDID data to the Enova DGX input connector's associated EDID EEPROM

IMPORTANT: Any analysis or editing of the EDID data necessary to support the equipment specific to the installation will need to be done separately prior to using the EDID Programmer view. A variety of freeware tools can be found on the Internet to help with these tasks.

Keep in mind that the EDID information for some equipment may not be compatible with the remaining equipment even with re-programming. In those cases, the signals will have limited routing options.

NOTE: If the signal from some of the equipment can only be routed to part of the destinations due to incompatible EDIDs, control can be simplified by creating a separate virtual matrix for the inputs and outputs involved (see "Creating a New Virtual Matrix" in the XNConnect Help file).

The remaining sections for the EDID Programmer view provide information on:

- Determining the need for EDID re-programming
- Reading and saving EDID data from an output, which received the information from its attached destination device
- Writing data to an Enova DGX input connector
- Additional HDMI EDID files for handling audio concerns

Determining the Need for EDID Re-programming

Ideally EDID analysis will have been completed during installation specification. Consideration should be given to the use of DXLink Output Boards and corresponding DXLink Receivers which (in almost every case) will remedy incompatible source and destination resolution issues. If EDID analysis was not possible but all of the system's devices are now available, the most effective way to proceed is to test if the signal from each source device can be routed through the Enova DGX Switcher to each of the destination devices. If they can be routed, then EDID re-programming is *not* necessary.

A method of control is not specified in the following instructions. Any board you think might need EDID re-programming *must* have the destination devices (and modules if applicable) attached before completing the following procedure.

Determining if EDID Re-programming Is Necessary

1. Route the first input to all of the applicable outputs.
2. Check each destination display to verify that the picture is present, making note of any that are not.
3. Repeat Steps 1 and 2 for each of the remaining inputs.

IMPORTANT: If any of the destinations do not display a picture, analysis or editing of the EDID data may be necessary prior to using the EDID Programmer view in the DGX Configuration Software. A variety of freeware tools can be found on the Internet to help with these tasks.

Board Support for DVI and HDMI Signals - Changing the EDID Setting

Another reason to reprogram EDIDs is to support different source signals on a single board. Because each input can be changed independently (e.g., an HDMI Board can support both HDMI and DVI sources), inputs can be set up for specific sources or for the most common source device expected to be connected.

NOTE: HDMI-to-DVI or DVI-to-HDMI conversion requires an applicable conversion cable.

The EDID resolution and audio support variances between HDMI and DVI (which are provided as defaults) help to identify if they need to change from the original (factory loaded) EDIDs on each input.

DVI Boards

The DVI Input Boards come pre-loaded with EDIDs typical for DVI output devices (computer monitors, etc.) which do not support embedded audio signals. However, they will allow HDMI with embedded audio formats through if the default EDID setting is changed via DGX Configuration Software using a file from the EDID Library (see Option 2 below).

HDMI Boards

The HDMI Input Boards come preloaded with EDIDs typical for HDMI output devices (DVD players, etc.). However, they will allow DVI formats through if the default EDID setting is changed via DGX Configuration Software using a file from the EDID Library (see Option 2 below).

Options for Re-programming EDIDs

If EDID re-programming is necessary, use one of the following two options.

- **Option 1:** Install the DGX Configuration Software and open the EDID Programmer view. Read the EDID from the output connected to the destination device and write it to the DXLink, DVI, or HDMI input connector.
- **Option 2:** Install the DGX Configuration Software and open the EDID Programmer view. Check the AMX_EDID_Library file at www.amx.com (search for EDID Library) to determine if one of the custom EDID files meets the needs of the equipment. (The custom EDID files are variants of base EDIDs.) Open and write the custom EDID file to the DXLink, DVI, or HDMI input connector.

NOTE: If you have changed EDID from the default (which supports 2 channel L-PCM as embedded audio) and are experiencing audio problems, it may be because you are trying to pass Dolby or DTS or high PCM frequency rates and the destination device does not support them. If you are experiencing video problems, it may be because you are trying to pass a video format that the destination device does not support. In either of these cases, re-programming the EDID (below) or re-routing the signal via the System Configuration interface to an Audio Switching Board's down-mix channel (see page 130) may help resolve the problem.

Reading and Saving EDID Data from a Destination Device

In the EDID Programmer view, the Save to File option under the File menu can be used to save the EDID information as an .edid file. The saved file can be opened as a text file (from the File menu, select Open File) and edited or opened and written to an input (click the Write button).

The instructions that follow tell how to use the EDID Programmer view to read and save the EDID information from an output, which is receiving the EDID information from a destination device.

- DXLink Fiber hardware in Unidirectional or Data Link-lost Mode – EDID timings are not accessible as there is no return path available to receive the information.
- The availability of the Read and Write buttons depends on whether an input or output is selected in the device tree on the left. (Read from an output and write to an input.)

Reading and Saving EDID Data

1. On the PC, open the DGX Configuration Software and select the EDID Programmer tab (FIG. 166):

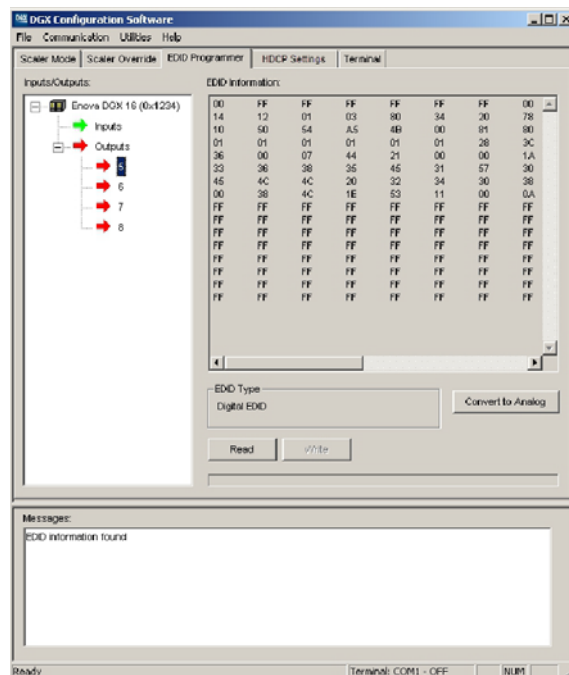

FIG. 166 EDID Programmer view

2. From the Inputs/Outputs device tree on the left, select an output from which to read the EDID information that it receives from the destination device.

3. Click Read to read the EDID information. The results display in the large read-only area.
4. From the File menu, select Save to File (select location, enter file name, and click Save).

Leave the EDID Programmer view open for using the instructions on writing the EDID to a DGX Digital Media Switcher input connector below.

NOTE: *If the program cannot read and write the EDID information, the system may not support all of the DGX Configuration Software functionality.*

Writing EDID Data to DGX DXLink, DVI, or HDMI Input Connector

The instructions that follow tell how to use the EDID Programmer view to write the EDID information from an output or from a saved file to the EDID chip for an input connector on a DGX DXLink, DVI, HDMI, or 4K HDMI Input Board.

NOTE: *DXLink Fiber hardware in Unidirectional or Data Link-lost Mode – EDID timings are not accessible as there is no return path available to receive the information.*

To write EDID data to the EDID chip for an input connector:

1. In the DGX Configuration Software interface, select the EDID Programmer tab.
2. Save the board's EDID default as a backup (assumes the board has factory default EDID programming).
 - a. Select the input connector.
 - b. Click Read.
 - c. From the File menu, select Save to File (select location, enter file name, and click Save).
3. If an EDID was just read from an output (see page 200), select the input to which you want to write that EDID information.

- or -

 From the File menu, select Open File to select an .edid file to be written to the DXLink, DVI, HDMI, or 4K HDMI input connector.
4. Click Write to write the EDID information to the input connector.
5. If applicable – Repeat any of the steps that are necessary for any additional DXLink, DVI, HDMI, or 4K HDMI input connectors.

Custom HDMI and DVI EDID Files for Handling Audio/Video Concerns

HDMI, DVI, DXLink Twisted Pair, or DXLink Fiber Boards will be connected to multiple source and sink devices. These devices often support different video and audio formats. Potentially, neither the video nor the audio routed by the system can be displayed on one or more of the destination devices.

Customizing the EDID content at the Enova DGX input channels is one way to be sure that the formats provided by the source are compatible with most/all of the destination devices.

The HDMI and DXLink Twisted Pair Boards are preprogrammed with the equivalent of the file "AMX_HDMI1v3_Standard.edid" to support basic audio only (2 CH L-PCM 32 kHz, 44.1 kHz, and 48 kHz). The DXLink Fiber Boards initially do not have EDIDs loaded; however, they obtain EDIDs (on a per channel basis) as soon as they are connected to DXLink Fiber Transmitters. The DVI Board is preprogrammed with the equivalent of the file "AMX_DVI1v1_BaseBlockOnly.edid." Both files are in the AMX_EDID_Library.

The files in the following two tables are located in the AMX_EDID_Library file at www.amx.com (search for EDID Library). Additional files provided in the EDID Library include support for 3D deep color and High Bit Rate (HBR) Audio.

Files using 1080p (VIC 16) as the preferred and native video resolution:

File Name	Monitor Name	Description
AMX_HDMI1v3_Standard.edid*	AMX_HDMI1v3	Supports basic audio only: uncompressed 2 CH L-PCM stereo audio with sample rate of 32 kHz, 44.1 kHz, or 48 kHz.
AMX_HDMI1v3_A_Surround.edid*	AMX_HDMI1v3_A	Supports surround sound: audio up to 192 k for 48 kHz Dolby Digital (5.1), 48 kHz DTS (5.1), and basic audio (uncompressed 2 CH L-PCM stereo audio with sample rate of 32 kHz, 44.1 kHz, or 48 kHz).

Files using 720p (VIC 4) as the preferred and native video resolution:

File Name	Monitor Name	Description
AMX_HDMI1v3_B_720p.edid	AMX_HDMI1v3_B	Supports basic audio only: uncompressed 2 CH L-PCM stereo audio with sample rate of 32 kHz, 44.1 kHz, or 48 kHz.
AMX_HDMI1v3_C_720p_Surround.edid	AMX_HDMI1v3_C	Supports surround sound: audio up to 192 k for 48 kHz Dolby Digital (5.1), 48 kHz DTS (5.1), and basic audio (uncompressed 2 CH L-PCM stereo audio with sample rate of 32 kHz, 44.1 kHz, or 48 kHz).

NOTE: * File names containing "AMX_HDMI1v3" do not in any way refer to the HDMI v1.3 standard.

Audio Troubleshooting

The default EDID for input boards only supports 2 channel L-PCM audio. If a source chooses to ignore this EDID and send a format that is not in the EDID, the audio may not pass through the Enova DGX at all or it may be distorted.

To present other types of audio formats to the source, a different EDID must be loaded (see the AMX EDID Library at www.amx.com (search for EDID Library)).

If after changing the EDID on the input board, the audio is still distorted or is not present on the destination device, then the device may not be capable of supporting the requested audio format with the newly loaded EDID setting. In this case, a standard EDID should be used and the sources set up to only pass the type of audio that the downstream destination devices can handle.

Checking for Support

One way to check if a destination supports a particular type of audio format is to capture the EDID using DGX Configuration software's EDID Programmer tab and paste the EDID data into a free-ware EDID reader program (e.g., www.edidreader.com).

For additional information and a table showing which types of audio the different types of boards support, see page 101.

Device Between HDMI Output Board and Monitor

Sometimes a device (e.g., a video processor) between a DGX HDMI Output Board and the destination monitor is intentionally installed to alter the image scale. If that is not the case and you have image problems, you need to be aware that the scaler override function is responding to the EDID from the extra device rather than from the monitor. One possible solution is to use the DGX Configuration Software to read and save the EDID directly from the monitor and then apply the override values to the output (directions follow).

Reading EDID Directly From Monitor And Applying Override Values To Output

1. Remove the device between the output and the monitor.
2. Connect the output directly to the monitor.
3. Install and open DGX Configuration Software (see page 270).
4. Select the Scaler Override tab.
5. Under EDID Source, select the Enclosure and select the Output number connected to the desired destination from the drop-down lists.
6. Click Refresh EDID.
7. From the File menu, select Save to File and save the settings to a file.
8. Replace the device between the output and the monitor.
9. From the File menu, select Open File and open the previously saved file.
10. Click Apply to transmit the settings in the file to the output. This action is temporary until the settings are stored on the connector in Step 12. Otherwise, the settings last only until power is cycled. The display re-syncs with the output.
11. Verify that the display is satisfactory before proceeding.
12. Click Save to store the currently displayed settings to the connector and persist them in memory. If the settings have been changed since clicking Apply, the newest settings will be saved.

HDCP Settings View

The HDCP Settings view controls HDCP support, enabling and disabling support on specific HDMI or DVI inputs. The default setting is for HDCP to be enabled.

Enabling/Disabling HDCP Support For HDMI, 4K HDMI, or DVI Input

1. Select the input (or select multiple inputs) on the left (FIG. 167):

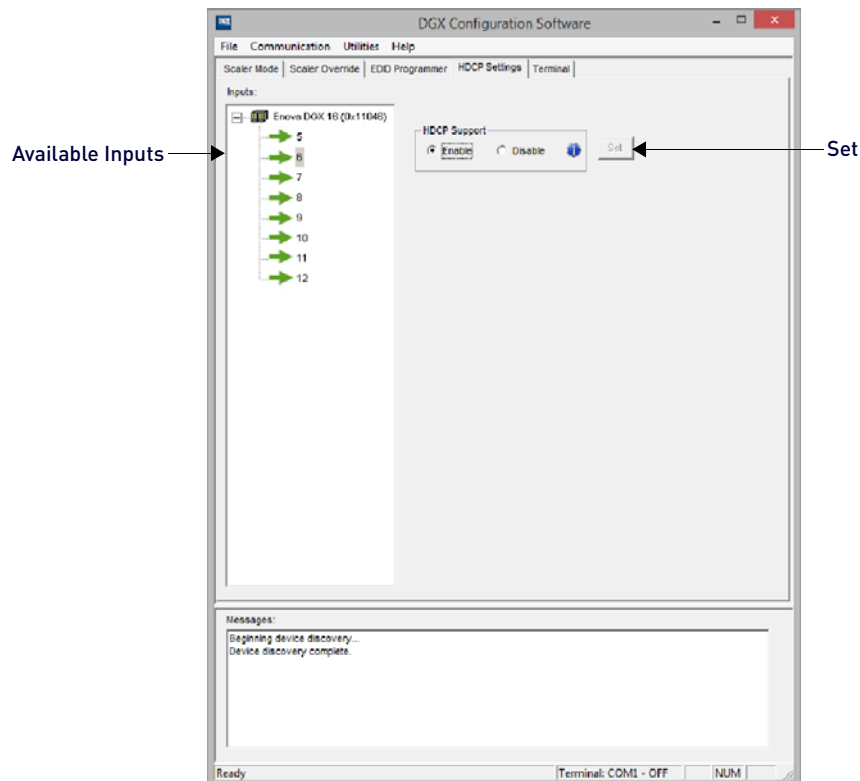

FIG. 167 HDCP Settings view

2. Under HDCP Support, click the desired option: Enable or Disable.
3. Click the Set button.
4. Repeat as necessary for additional inputs.

NOTE: To enable or disable HDCP support over the DXLink line, send the appropriate `SEND_COMMAND (HDCP-<ENABLE|DISABLE>)` to the DXLink Transmitter. For details, see the "NetLinx Programming" chapter of the "DXLink™ Twisted Pair Transmitters/Receiver Hardware Reference Manual" or the "DXLink™ Fiber Transmitters and Receivers Hardware Reference Manual."

Terminal View

The Terminal view provides basic terminal emulation. This view allows you to enter and send BCS (Basic Control Structure), auxiliary, diagnostic, and DGX_SHELL commands to the system.

NOTE: If you plan to use the terminal emulation function of the software, a serial connection is required.

IMPORTANT: You must click the Connect button to establish serial communication with the system before you can use the terminal emulation function in the DGX Configuration Software. When done, be sure to click the Disconnect button.

BCS Commands

BCS protocol is an AMX command language for control operations. For complete information on BCS commands, see the *Programming Guide – BCS Basic Control Structure Protocol* at www.amx.com.

Auxiliary BCS Commands

Auxiliary commands are also included in the *Programming Guide – BCS Basic Control Structure Protocol* at www.amx.com. The two most common auxiliary commands are: `~app!` (to cause a warm reboot) and `~scr!` (to view a splash screen).

DGX_SHELL Commands

The Enova DGX Switcher supports a number of shell (command-line interpreter) commands for a variety of functions, both basic and advanced (see page 273).

NOTE: `DGX_SHELL` Commands are case-sensitive.

Sending a Command to the System

1. In the DGX Configuration Software interface, select the Terminal tab (FIG. 168):

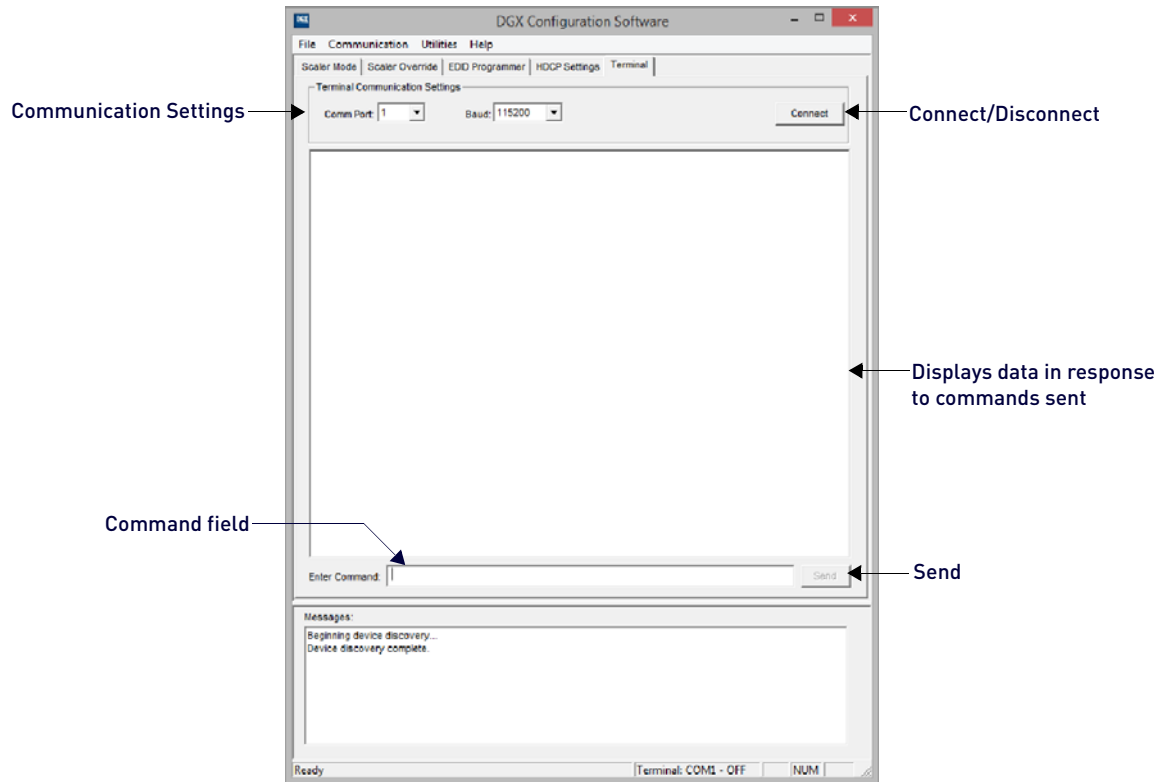

FIG. 168 Terminal view

2. Select and set the Terminal Communication Settings: Comm Port and Baud (rate). The default baud rate for the Enova DGX 100 Series Switcher is 115200.
3. Click Connect.
4. Press CTRL+C to clear the communication channel and begin sending DGX_SHELL commands. (Type "bcs" and click the Send button to enter the BCS environment. Press CTRL+C to return to the DGX_SHELL environment.)
5. Enter additional commands as necessary.
6. When done, click Disconnect.

NOTE: *DGX_SHELL* commands are explained on page 273 and BCS commands are explained in the [Programming Guide – BCS Basic Control Structure Protocol](#) at www.amx.com.

Saving the Current Data In The Terminal Window To a File

From the File menu, select Save to File (select location, enter file name, and click Save). The file format defaults to a .txt file.

NOTE: *Select and copy any or all of the data in the terminal window and then paste it into another program.*

Appendix G - External Serial Controllers

Overview

Enova DGX Switchers can be controlled externally by attaching a serial control device that uses one of the communication protocols listed below:

- BCS (USB) – ASCII sent over a USB cable via the USB (mini-B) Control port
- BCS (Serial) – ASCII sent over a null modem serial cable via the serial (DB-9) Control port

The external serial control device can be attached to the USB Control port via a USB cable (see page 283) or to the serial Control port (DB-9) over an RS-232 (null modem) serial cable (see page 286). PCs are common serial controllers.

Once a PC is attached to an Enova DGX Switcher via one of its Control ports, the system can be controlled by entering BCS commands into a terminal emulation program, e.g., the terminal in NetLinx Studio (Tools/Terminal Session).

NOTE: *The two Control ports provide direct serial control of matrix switcher processing (they do not work on the same layer of control as the integrated NetLinx NX Master, which uses the LAN 100/1000 and Program ports). For information on establishing TCP/IP control from the integrated NetLinx NX Central Control Processor to a LAN, see page 73.*

External Serial Control Options

Although the main method of control for the Enova DGX Switcher is the integrated NetLinx NX Central Control Processor (for System Configuration/Switching page information, see page 127; for SEND_COMMANDS, see page 211), several external serial control methods are also available. The communication protocols listed at the top of this page are used for these control options:

BCS Control

BCS (Basic Control Structure) is a command language that was developed for executing control operations and for diagnostic purposes. BCS commands are issued via a terminal emulation program, e.g., the terminal in NetLinx Studio (Tools/Terminal Session). For information on BCS commands, see the *BCS (Basic Control Structure) Protocol Programming Guide* at www.amx.com.

Third-Party Controllers

Third-party controllers connect to either the serial port (DB-9) or the USB (mini-B) port on the CPU. If using a third-party controller, see the controller documentation for setup and operating instructions.

External Serial Control via USB Control Port

Controlling an Enova DGX Switcher using a connection through the USB Control port requires the creation of a virtual COM port. Once created, the virtual COM port is used as if it were a standard serial connection and can connect to a control application or to a terminal emulation program. For terminal emulation, use the terminal in NetLinx Studio (Tools/Terminal Session) or another terminal emulation program.

IMPORTANT: *You must have adequate rights to install USB device drivers to the PC. Check with your System Administrator to be sure you have the required access.*

If establishing a new connection, complete all of the steps in the following instructions.

- or -

If reconnecting after previously establishing a USB connection, complete Steps 2 and 3 and then set up and run the desired software program or utility.

Attaching a PC To the USB (mini-B) Port and Establishing a Virtual COM Port

1. Download the APBridge.inf file, which is located at www.amx.com (enter APBridge in the Search AMX.com field in the upper right-hand corner of the site). No user permissions are required.
2. Apply power to the enclosure (see page 66).
3. Connect the enclosure to a PC running Windows with USB cable (FIG. 169):

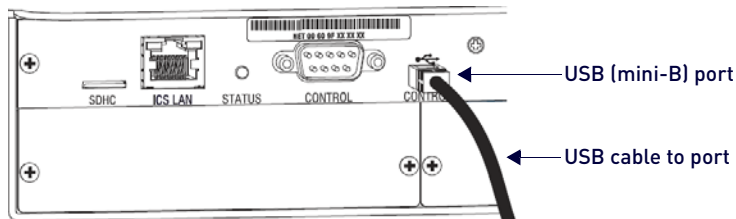

FIG. 169 USB cable connected to USB port on Enova DGX 3200 and to PC

4. *If establishing a new connection, complete the remaining steps.*

- or -

If reconnecting after previously establishing a USB connection, go to Step 11 to run the desired software.

NOTE: The following dialog boxes appear only during the initial USB connection. Once the virtual COM port has been assigned to the enclosure, the dialog boxes do not appear again. If they do appear, you have connected the USB plug to a different COM port on the PC than the initial one – either switch to the initial COM port or establish a virtual COM port for the new port on the PC.

In the Driver Software Installation window, click **Close** (FIG. 170):

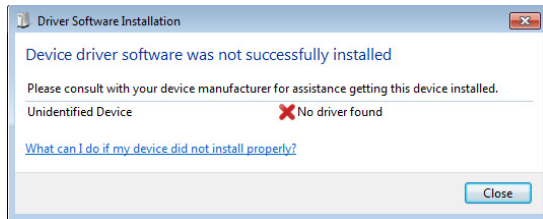

FIG. 170 Driver Software Installation window

- Open the Device Manager window (Start/Control Panel/Device Manger icon)*, open **Other devices**, right-click on **Unknown device** and select Properties from the context menu to open the *Unknown Device Properties* window.

NOTE: The Device Manager may have a different location depending on the operating system and theme selected.

- In the *Driver* tab, select **Update Driver** (FIG. 171):

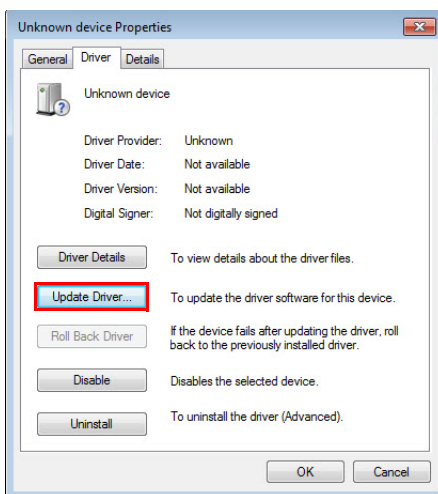

FIG. 171 Unknown Device Properties window (Driver tab)

- In the *Update Driver Software - Unknown Device* dialog, browse for the **APBridge.inf** file and select **Next** (FIG. 172):

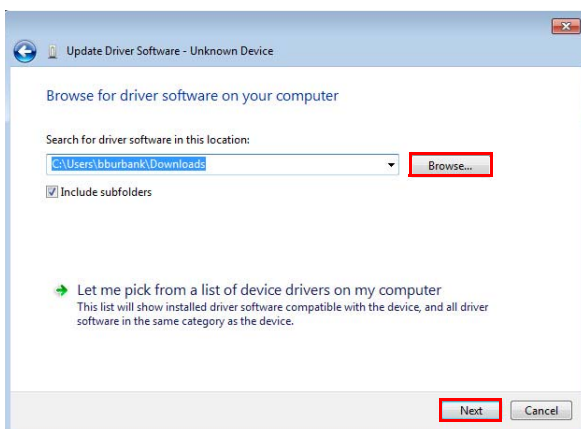

FIG. 172 Update Driver Software - Unknown Device dialog

In the second Update Driver Software window, click **Close** (FIG. 173):

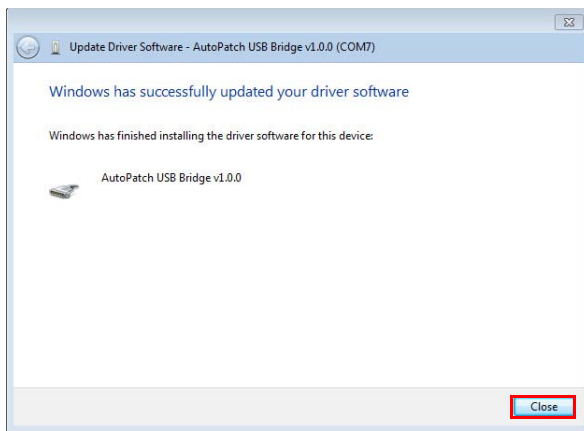

FIG. 173 Update Driver Software - Unknown Device dialog

NOTE: A Windows Security window may open and ask if you want to install a driver with an unverified publisher. Select the *Install this driver software anyway* option.

8. If the AutoPatch USB Bridge port specifies the COM number, go to Step 11. If the port does not specify a COM number, right-click the **AutoPatch USB Bridge**, select **Properties**, and complete all remaining steps (FIG. 174):

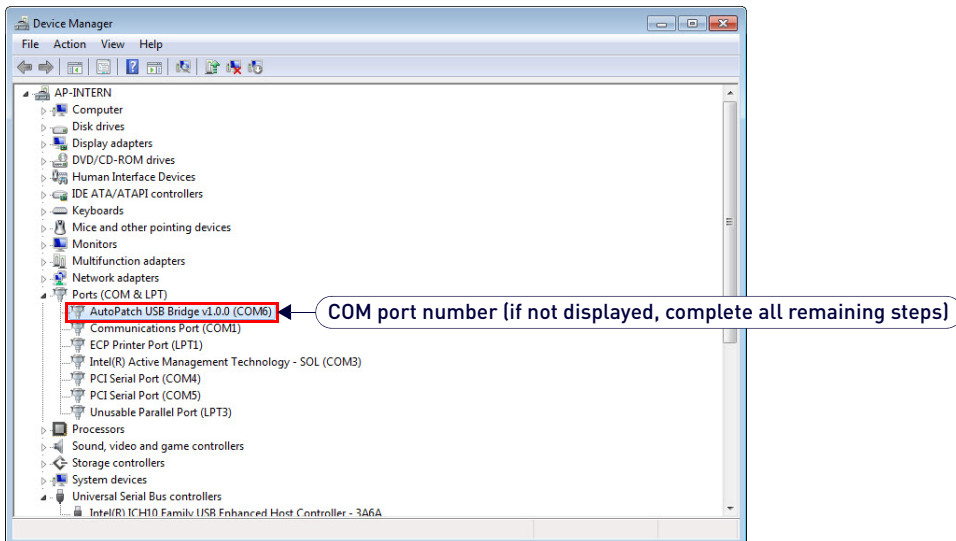

FIG. 174 Device Manager

9. In the *AutoPatch USB Bridge Properties* dialog, select the **General** tab (FIG. 175):

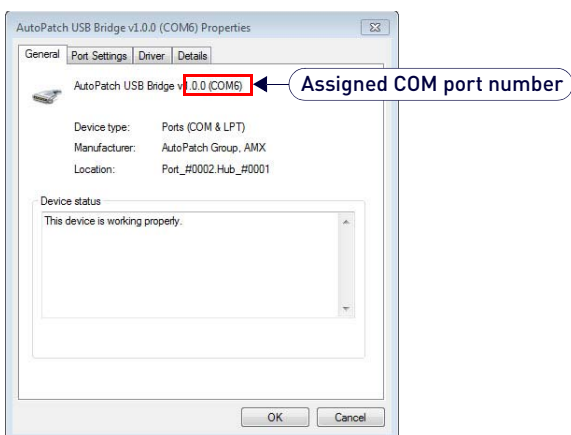

FIG. 175 AutoPatch USB Bridge Properties dialog (General tab)

10. Make note of the COM port number assigned to the AutoPatch USB Bridge.

This port number *must* be entered when setting a connection in a software program or a terminal emulation program. The PC will always associate a specific USB connector with the assigned virtual COM port. The PC *will not* recognize the module if you disconnect and reconnect using a different COM port on the PC.

However, it will attempt to install a new virtual COM port using the new port. If completed, the new port will be assigned a different COM number.

IMPORTANT: You *must* identify the virtual COM port assigned to the USB connector to enable communication between the Control PC and the switcher.

11. Set up and run the desired method of control:
 - **AMX Controller** – For control programming information, see the manual for the specific controller.
 - **Terminal Emulation** – Open the program (see "Terminal Emulation" on page 287). Check to be sure the COM port is set for the port determined in the previous steps. Set the settings to match the Enova DGX 100 Series defaults:
 - baud rate – 115200
 - data bits – 8
 - parity – 1
 - stop bits – none
 - flow control – 1

IMPORTANT: If power is cycled on the enclosure, the USB connection *must* be reestablished. (1) Remove the USB cable, (2) close the software application in use, (3) reconnect the USB cable to the same USB connector that was used previously, and (4) reopen the communication software.

External Serial Control via DB-9 Control Port

The DB-9 Control port provides a standard serial connection and can be used to connect directly to a control application or to a PC running a terminal emulation program. To access the terminal emulation program in NetLinX Studio, go to Tools/ Terminal Session.

PC Requirements for Serial Control

- Windows 7 or Windows 8
- Terminal emulation program
- Serial port or USB port

RS-232 Pin Diagram

A serial connection via the Control port requires a null modem cable that matches the pin diagram in FIG. 176 for RS-232 without hardware flow control. Enova DGX Switchers require pins 2, 3, and 5 only (FIG. 176):

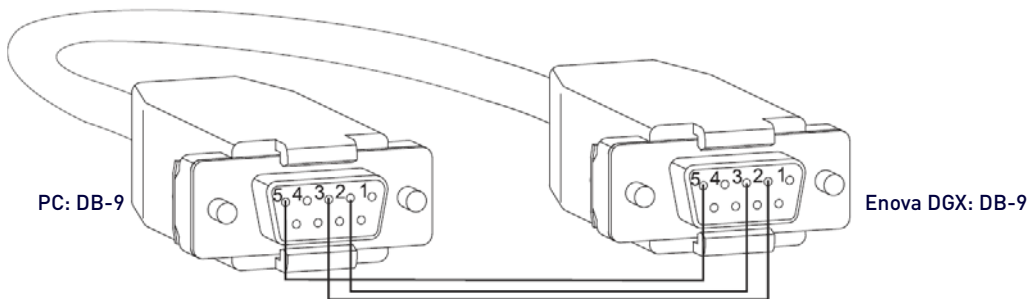

FIG. 176 RS-232 null modem cable pin diagram, no hardware flow control

Establishing External Serial Control Via the Control (DB-9 serial) Port

1. Plug one end of the null modem serial cable into the Control port on the enclosure (FIG. 177):

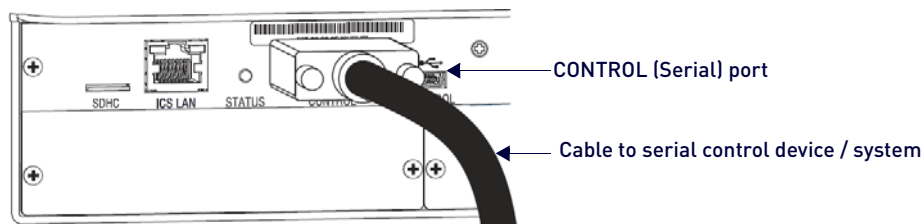

FIG. 177 RS-232 null modem cable pin diagram, no hardware flow control

2. Plug the other end of the serial cable into the serial port on the serial controller.
3. If not already on, apply power first to the switcher and then to the source and destination devices (see page 66).

CAUTION: To avoid system damage, follow the power-up sequence on page 66. We recommend attaching all power cords to a surge protector and/or AC line conditioner.

4. Setup and run the desired method of control:
 - **AMX Controller** – For control programming information, see the specific controller's manual.
 - **Terminal emulation** – Open the program, set the COM port settings to match the following default values:

Baud Rate - 115200
 Data Bits - 8
 Parity - None
 Stop Bits - 1
 Flow Control - None

NOTE: For terminal emulation via the serial port, use the terminal in NetLinx Studio (see below) or another terminal emulation program.

Serial Communication Settings

If you are controlling the system with a serial controller, use serial communication software and make sure the baud rate is set correctly for the system.

Supported baud rates are 115200 (default), 19200, 38400, and 57600. The settings on the PC serial communication software and the enclosure *must* correspond to each other.

If a change is required to make them match, changing the PC's settings is preferable. If you decide to change the enclosure's settings instead, use NetLinx Studio.

Terminal Emulation via NetLinx Studio

For terminal emulation, use the terminal in NetLinx Studio (Tools/Terminal Session) or another terminal emulation program. When power is applied to the enclosure, the terminal will display a one-line splash screen followed by "Ready." The system is ready to accept commands (FIG. 178):

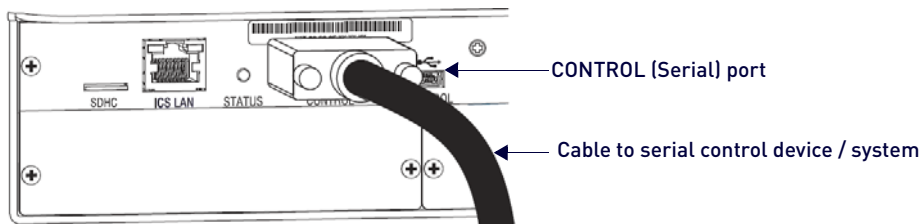

FIG. 178 Power-up splash screen in NetLinx Studio Terminal

Appendix H - Supported Output Resolutions

ICSP Settable Output Resolutions

The resolutions in the following table are supported on HDMI and DXLink output boards and can be set using either the System Configuration interface (see page 134) or a SEND_COMMAND. The horizontal/vertical/refresh information from the Resolution Name (in the first column) can be entered in a SEND_COMMAND command (VIDOUT_RES_REF) to specify scaling settings. If sending the command to the output port, do not include the "p" where indicated. If sending the command directly to the DXLink endpoint, the "p" is required. For complete command information, see page 227.

NOTE: The resolutions and timings in the table below can only be changed with SEND_COMMANDS.

ICSP Supported Output Resolutions					
Resolution Name	Horizontal Active Pixels	Vertical Active Pixels	Refresh (Hz)	Comments	Video Standard
640x480,60	640	480	60		VESA DMT
640x480,72	640	480	72		VESA DMT
640x480,75	640	480	75		VESA DMT
800x600,60	800	600	60		VESA DMT
800x600,72	800	600	72		VESA DMT
800x600,75	800	600	75		VESA DMT
1024x768,60	1024	768	60		VESA DMT
1024x768,70	1024	768	70		VESA DMT
1024x768,75	1024	768	75		VESA DMT
1280x720,50	1280	720	50	720p**	CTA 861
1280x720,60	1280	720	60	720p**	CTA 861
1280x768,60	1280	768	60		
1280x800,60	1280	800	60		VESA CVT
1280x1024,60	1280	1024	60		VESA DMT
1360x768,60	1360	768	60		VESA DMT
1440x900,60	1440	900	60		VESA CVT
1400x1050,60	1400	1050	60		VESA CVT
1600x1200,60	1600	1200	60		VESA DMT
1680x1050,60	1680	1050	60		VESA CVT
1920x1080,50	1920	1080	50	1080p**	CTA 861
1920x1080,60	1920	1080	60	Reduced Blanking	VESA CVT-R
1920x1080p,60	1920	1080	60	1080p**	CTA 861
1920x1200,60	1920	1200	60	Reduced Blanking	VESA CVT-R
3840x2160,24*	3840	2160	24	See Footnote	CTA 861
3840x2160,25*	3840	2160	25	See Footnote	CTA 861
3840x2160,30*	3840	2160	30	See Footnote	CTA 861
4096x2160,24*	4096	2160	24	See Footnote	CTA 861
4096x2160,25*	4096	2160	25	See Footnote	CTA 861
4096x2160,30*	4096	2160	30	See Footnote	CTA 861

* Resolution requires end-to-end (source, transport, destination) 4K equipment.

** When sent to a DXLink RX, these formats include a "p." When sent to the 5002 port (even if the system is connected to a DXLink RX), do not use a "p."

NOTE: The Consumer Technology Association (CTA) was formerly known as the Consumer Electronics Association (CEA): the CEA 861 video standard has been renamed to CTA 861.

Digital Video Output Resolution Support

IMPORTANT: The resolutions and timings in the list below are supported by HDMI and DLink outputs using SmartScale. They can be set manually via DGX Configuration Software (except for 4K resolutions).

Digital Video Output Resolution Support				
DMT	CTA 861	CVT	CVT-RB	GTF
640x480@60Hz	640x480@60Hz	640x480@72Hz	800x600@60Hz (RB)	640x480@72Hz
640x480@72Hz	720x480@60Hz	640x480@85Hz	1024x768@60Hz (RB)	640x480@85Hz
640x480@75Hz	720x480@120Hz	800x600@56Hz	1280x720@60Hz (RB)	800x600@56Hz
640x480@85Hz	720x480@240Hz	800x600@60Hz	1280x800@60Hz (RB)	800x600@60Hz
800x600@56Hz	720x576@50Hz	800x600@72Hz	1280x960@60Hz (RB)	800x600@72Hz
800x600@60Hz	720x576@100Hz	1024x768@60Hz	1280x1024@60Hz (RB)	1024x768@60Hz
800x600@72Hz	720x576@200Hz	1024x768@70Hz	1360x768@60Hz (RB)	1024x768@70Hz
800x600@75Hz	1280x720@50Hz	1024x768@75Hz	1400x1050@60Hz (RB)	1024x768@75Hz
800x600@85Hz	1280x720@60Hz	1152x864@75Hz	1440x900@60Hz (RB)	1152x864@75Hz
800x600@120Hz (RB)	1280x720@100Hz	1280x720@60Hz	1600x1200@60Hz (RB)	1280x720@60Hz
1024x768@60Hz	1280x720@120Hz	1280x800@60Hz	1680x1050@60Hz (RB)	1280x800@60Hz
1024x768@70Hz	1440x480@60Hz	1280x960@60Hz	1920x1080@60Hz (RB)	1280x960@60Hz
1024x768@75Hz	1440x576@50Hz	1280x1024@60Hz	1920x1200@60Hz (RB)	1280x1024@60Hz
1024x768@85Hz	1920x1080@24Hz	1280x1024@70Hz		1280x1024@70Hz
1024x768@120Hz (RB)	1920x1080@25Hz	1360x768@60Hz		1360x768@60Hz
1152x864@75Hz	1920x1080@30Hz	1360x768@70Hz		1360x768@70Hz
1280x720@60Hz	1920x1080@50Hz	1400x1050@60Hz		1400x1050@60Hz
1280x768@60Hz (RB)	1920x1080@60Hz	1400x1050@70Hz		1400x1050@70Hz
1280x768@60Hz	2560x1080@50Hz*	1440x900@60Hz		1440x900@60Hz
1280x768@75Hz	2560x1080@60Hz*	1440x900@70Hz		1440x900@70Hz
1280x768@85Hz	3840x2160@23/24Hz*	1600x1200@60Hz		1600x1200@60Hz
1280x768@120Hz (RB)	3840x2160@25Hz*	1680x1050@60Hz		1680x1050@60Hz
1280x800@60Hz (RB)	3840x2160@29/30Hz*			
1280x800@60Hz	3840x2160@50Hz**^			
1280x800@75Hz	3840x2160@59/60Hz**^			
1280x800@85Hz	4096x2160@24Hz*			
1280x800@120Hz	4096x2160@25Hz*			
1280x960@60Hz	4096x2160@30Hz*			
1280x960@85Hz	4096x2160@50Hz**^			
1280x1024@60Hz	4096x2160@59/60Hz**^			
1280x1024@75Hz				
1280x1024@85Hz				
1360x768@60Hz				
1360x768@120Hz (RB)				
1366x768@60Hz				
1366x768@60Hz (RB)				
1400x1050@60Hz (RB)				
1400x1050@60Hz				
1400x1050@75Hz				
1440x900@60Hz (RB)				
1440x900@60Hz				
1440x900@75Hz				
1440x900@85Hz				
1600x900@60Hz (RB)				
1600x1200@60Hz				
1680x1050@60Hz (RB)				
1680x1050@60Hz				
1920x1080@60Hz				
1920x1200@60Hz (RB)				

NOTE: The Consumer Technology Association (CTA) was formerly known as the Consumer Electronics Association (CEA): the CEA 861 video standard has been renamed to CTA 861.



© 2018 Harman. All rights reserved. Metreau, NetLinx, AMX, AV FOR AN IT WORLD, HARMAN, and their respective logos are registered trademarks of HARMAN. Oracle, Java and any other company or brand name referenced may be trademarks/registered trademarks of their respective companies. AMX does not assume responsibility for errors or omissions. AMX also reserves the right to alter specifications without prior notice at any time. The AMX Warranty and Return Policy and related documents can be viewed/downloaded at www.amx.com.

LAST REVISED:
3/27/2018

3000 RESEARCH DRIVE, RICHARDSON, TX 75082 AMX.com | 800.222.0193 | 469.624.8000 | +1.469.624.7400 | fax 469.624.7153
AMX (UK) LTD, AMX by HARMAN - Unit C, Auster Road, Clifton Moor, York, YO30 4GD United Kingdom • +44 1904-343-100 • www.amx.com/eu/